



**Locks for  
metal frames**

---

<b>Perforza</b>	2-6	<b>Portoncino</b>	2-135
<b>Multiblindo  Motion</b>	2-30	<b>Gates</b>	2-139
<b>Multiblindo Easy</b>	2-36	<b>Shutters and garage doors</b>	2-142
<b>Multiblindo classic</b>	2-44	<b>Chiuditutto</b>	2-146
<b>Electa multipoint</b>	2-71	<b>Match</b>	2-154
<b>Electa</b>	2-79	<b>Stiking plates</b>	2-162
<b>Shutters</b>	2-97		
<b>Locks for metal frames</b>	2-101		
<b>Mortice locks for metal frames</b>	2-108		
<b>2001 - 500 Electric locks</b>	2-125		
<b>Ferroglietto</b>	2-134		

For aluminium frames

For iron frames

Legend





## How to read the marking **UNI EN 12209:05**

**Classification for mechanical locks (lateral locking).**



<b>3</b>	<b>X</b>	<b>8</b>	<b>0</b>	<b>0</b>	<b>G</b>	<b>2</b>	<b>H</b>	<b>A</b>	<b>2</b>	<b>0</b>
Category of use	Durability and load on latchbolt	Door mass and locking force	Suitability for use on fire/smoke resistant doors	People's safety	Corrosion resistance and temperature requirement	Goods' security and drill resistance	Field of door application	Type of key operation and locking	Type of spindle operation	Key identification requirement

### Category of use

There are three grades (example: grade 1: for residential doors, grade 2: for offices doors, grade 3: for doors in public buildings)

### Durability and load on latchbolt

There are twelve grades (example: grade A: 50.000 operations and no load on latchbolt  
grade X: 200.000 operations and 120 N load on latchbolt)

### Door mass and locking force

There are nine grades (example: grade 1: up to 100 kg door mass with 50 N maximum locking force, grade 9: over 200 kg door mass with 15 N maximum locking force)

### Suitability for use on fire/smoke resistant doors

There are two grades (example: grade 0: non suitable for use on fire/smoke resistant door, grade 1: suitable for use on fire/smoke resistant door)

### People's safety

There is only one grade: grade 0: no safety requirement

### Corrosion resistance and temperature requirement

There are eight grades (example: grade 0: no corrosion resistance and temperature requirement, grade G: very high corrosion resistance and temperature requirement from -20°C up to +80°C)

### Goods' security and drill resistance

There are seven grades (example: grade 1: minimum security and no drill resistance, grade 7: very high security and drill resistance)

### Field of door application

There are fifteen grades (example: grade A: mortice lock for sliding or hinged door, grade T: rim lock for sliding or hinged door, front plate not supported)

### Type of key operation and locking

There are nine grades (example: grade A: cylinder lock or latch; manually locking,  
grade H: lock without key operation and automatically locking)

### Type of spindle operation

There are five grades (example: grade 0: lock or latch without follower, grade 4: lock or latch for heavy duty unsprung lever handle operation specified by the manufacturer)

### Key identification requirement

There are nine grades (example: grade 0: no requirements, grade H: minimum eight detaining elements, extended number of effective differs)

**For further information please refer to UNI EN 12209:05 standard**



## How to read the marking **prEN 15685**

**Classification for mechanical locks  
(multipoint locking).**



<b>3</b>	<b>X</b>	<b>8</b>	<b>A</b>	<b>0</b>	<b>G</b>	<b>7</b>	<b>3</b>	<b>0</b>
<b>Category of use</b>	<b>Durability and load on latchbolt</b>	<b>Door mass and locking force</b>	<b>Suitability for use on fire/smoke resistant doors</b>	<b>Key identification requirement</b>	<b>Corrosion resistance and temperature requirement</b>	<b>Security for locking points</b>	<b>Security for anti-separation points</b>	<b>Clenching points</b>

### Category of use

There are three grades (example: grade 1: for residential doors, grade 2: for offices doors, grade 3: for doors in public building)

### Durability and load on latchbolt

There are ten grades (example: grade A: 50.000 operations and no load on latchbolt for locks without latchbolt, grade Z: 500.000 operations and 120 N load on latchbolt)

### Door mass and locking force

There are ten grades (example: grade 1: up to 100 kg door mass and 50 N maximum locking force, grade 9: over 200 kg door mass and 15 N maximum locking force)

### Suitability for use on fire/smoke resistant doors

There are three grades (example: grade 0: non suitable for use on fire/smoke resistant door, grade B: suitable for use on fire/smoke resistant door)

### Key identification requirement

There are nine grades (example: grade 0: not applicable, grade H: minimum eight detaining elements, extended number of effective duffers)

### Corrosion resistance and temperature requirement

There are eight grades (example: grade 0: no corrosion resistance and no temperature requirement, grade G: very high corrosion resistance and temperature requirement from -25°C up to +70°C)

### Security for locking points

There are six grades (example: grade 0: no security requirements, grade 7: very high security with drill resistance)

### Security for anti-separation points

There are eight grades (example: grade 0: no declared anti-separation points, grade 7: very high performance with drill resistance)

### Clenching point

There are five grades (example: grade 0: no clenching force requirements, grade 4: clenching force = 120 N)

**For further information please refer to prEN 15685 standard**



**Perforza**  
Multipoint lock



## Perforza

**PERFORMA** by Iseo has been conceived and developed to meet the requirements of the European market by adopting two different centre distances: 85 and 92 mm. It can be operated by a European-profile cylinder with straight or 45° projecting cam. The top and bottom lock housings incorporate low friction chamfered sliding deadbolts providing a perfect alignment into the keeps. The unique locking action of these chamfered bolts when combined with the latest generation of profiles helps maintain weather seal compression for better thermal insulation and energy saving.



### It has been designed and tested

according to the European standards EN 12209:05 and prEN 15685:09. It resists lateral forcing with a thrust of over 1,000 kg and a front load of over 600 kg. The corrosion resistance is more than 240 hours in a saline environment. Endurance: tested to over 200,000 opening and closing cycles under a 120N load.

Example of certification: multipoint lock Performa models 7232 – 7235



### It's compatible

The lockcase has a width of 15 mm and, therefore, suits any type of applications for different frames materials.



### It's sealed

The lockcase is closed on all sides: this stops profile machining chips from entering the mechanism. The lock is equipped with a wheel-cam stopping device in case the cylinder is not present into the housing of lock.



### Easy locking

The gear box allows for a smoother and easier operation whilst turning the key during opening and closing.

### It's solid

Version with hardened deadbolts available on demand, providing greater resistance against cutting and drilling.



### It's well equipped

PERFORMA is well equipped with accessories to modify the lock: with a latch, a roller or a blanking cap for DEADBOLT only action. Such a versatile lock makes for a streamlined stockholding.



**Perforza 85 mm centre distance**

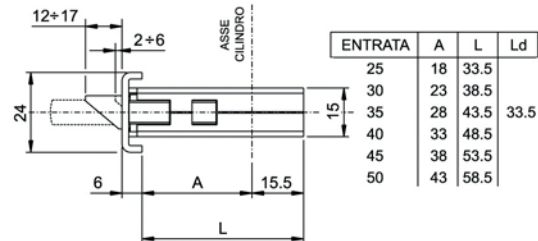
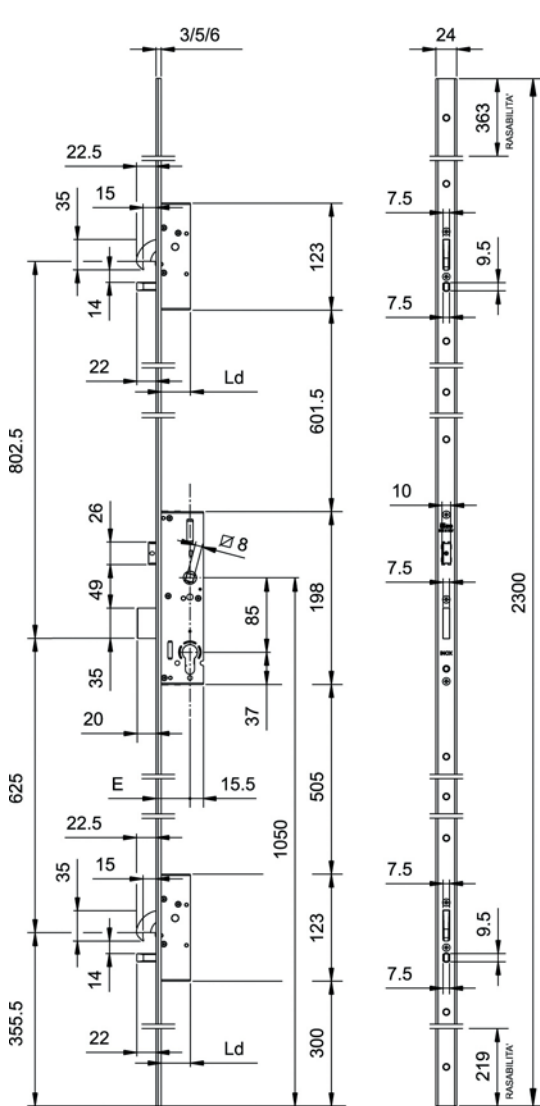
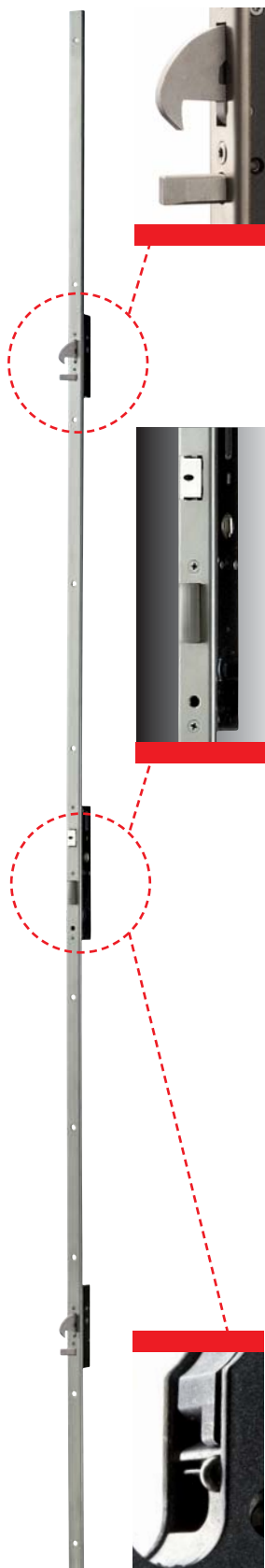

ENTRATA	A	L	Ld
25	18	33.5	
30	23	38.5	
35	28	43.5	33.5
40	33	48.5	
45	38	53.5	
50	43	58.5	

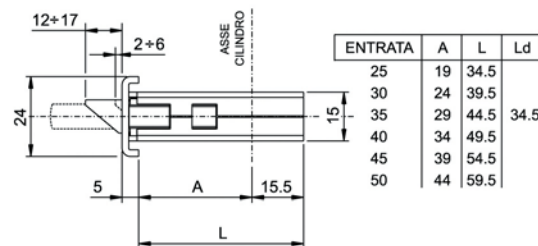

ENTRATA	A	L	Ld
25	19	34.5	
30	24	39.5	
35	29	44.5	34.5
40	34	49.5	
45	39	54.5	
50	44	59.5	

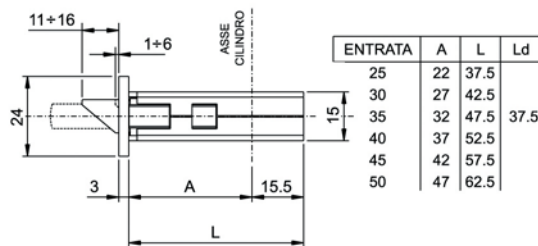

ENTRATA	A	L	Ld
25	22	37.5	
30	27	42.5	
35	32	47.5	37.5
40	37	52.5	
45	42	57.5	
50	47	62.5	

MULTIPOINT mortice lock for metal frames, 3-point locking,  
**ROTATING HOOK DEVIATORS AND SLIDING DEADBOLT LOCK**

Central lock, centre distance mm **85**, profile cylinder.

Throw mm 20, **reversible latchbolt**. The latchbolt can be replaced with roller or cap, mm 8 handle follower.

Closed case for lock and deviators.

2 nylon end blocks for U-version. Fixing screws. Instruction sheet.

The lock is equipped with a wheel-cam stopping device in case the cylinder is not assembled into the housing of lock.

**STAINLESS STEEL front plate.**

**Accessories to be ordered separately:**

Roller for central lock 040940

Cap for DEADBOLT only versions 040950

Striking plates

Electric strikers



## Locks for metal frames



Code

Status  
Single package  
Multiple package  
Min. ord.

### Perforza 85 mm centre distance

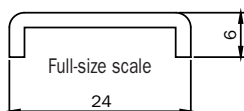

U-front plate mm <b>2300 x 24 x 6</b> in stainless steel. 85 mm centre distance. Backset mm 25 * <b>7255512528</b>	D	1	-	1
U-front plate mm <b>2300 x 24 x 6</b> in stainless steel. 85 mm centre distance. Backset mm 30 * <b>7255513028</b>	D	1	-	1
U-front plate mm <b>2300 x 24 x 6</b> in stainless steel. 85 mm centre distance. Backset mm 35 * <b>7255513528</b>	D	1	-	1
U-front plate mm <b>2300 x 24 x 6</b> in stainless steel. 85 mm centre distance. Backset mm 40 * <b>7255514028</b>	D	1	-	1
U-front plate mm <b>2300 x 24 x 6</b> in stainless steel. 85 mm centre distance. Backset mm 45 * <b>7255514528</b>	D	1	-	1
U-front plate mm <b>2300 x 24 x 6</b> in stainless steel. 85 mm centre distance. Backset mm 50 * <b>7255515028</b>	D	1	-	1

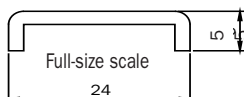

U-front plate mm <b>2300 x 24 x 5</b> in stainless steel. 85 mm centre distance. Backset mm 25 * <b>7255532528</b>	D	1	-	1
U-front plate mm <b>2300 x 24 x 5</b> in stainless steel. 85 mm centre distance. Backset mm 30 * <b>7255533028</b>	D	1	-	1
U-front plate mm <b>2300 x 24 x 5</b> in stainless steel. 85 mm centre distance. Backset mm 35 * <b>7255533528</b>	D	1	-	1
U-front plate mm <b>2300 x 24 x 5</b> in stainless steel. 85 mm centre distance. Backset mm 40 * <b>7255534028</b>	D	1	-	1
U-front plate mm <b>2300 x 24 x 5</b> in stainless steel. 85 mm centre distance. Backset mm 45 * <b>7255534528</b>	D	1	-	1
U-front plate mm <b>2300 x 24 x 5</b> in stainless steel. 85 mm centre distance. Backset mm 50 * <b>7255535028</b>	D	1	-	1

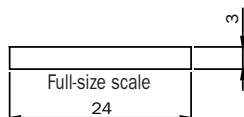

Flat front plate mm <b>2300 x 24 x 3</b> in stainless steel. 85 mm centre distance. Backset mm 25 * <b>7255012528</b>	D	1	-	1
Flat front plate mm <b>2300 x 24 x 3</b> in stainless steel. 85 mm centre distance. Backset mm 30 * <b>7255013028</b>	D	1	-	1
Flat front plate mm <b>2300 x 24 x 3</b> in stainless steel. 85 mm centre distance. Backset mm 35 * <b>7255013528</b>	D	1	-	1
Flat front plate mm <b>2300 x 24 x 3</b> in stainless steel. 85 mm centre distance. Backset mm 40 * <b>7255014028</b>	D	1	-	1
Flat front plate mm <b>2300 x 24 x 3</b> in stainless steel. 85 mm centre distance. Backset mm 45 * <b>7255014528</b>	D	1	-	1
Flat front plate mm <b>2300 x 24 x 3</b> in stainless steel. 85 mm centre distance. Backset mm 50 * <b>7255015028</b>	D	1	-	1

\* Available starting from the second half of 2010



**Perforza 85 mm centre distance**

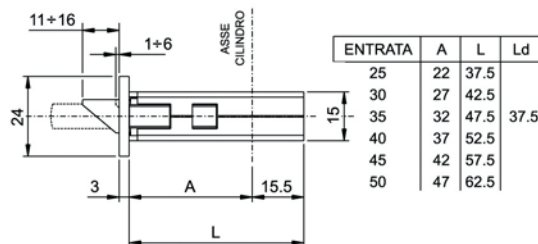
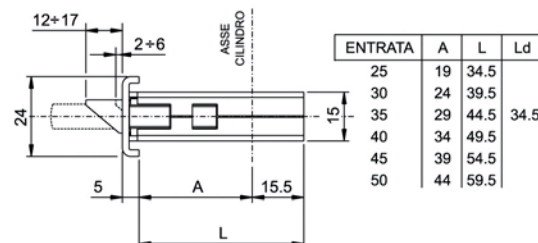
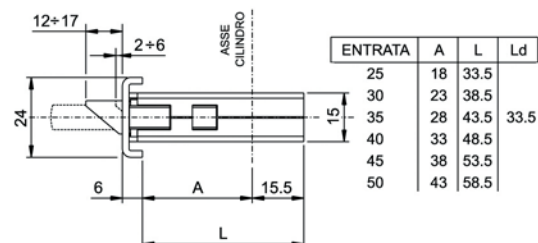
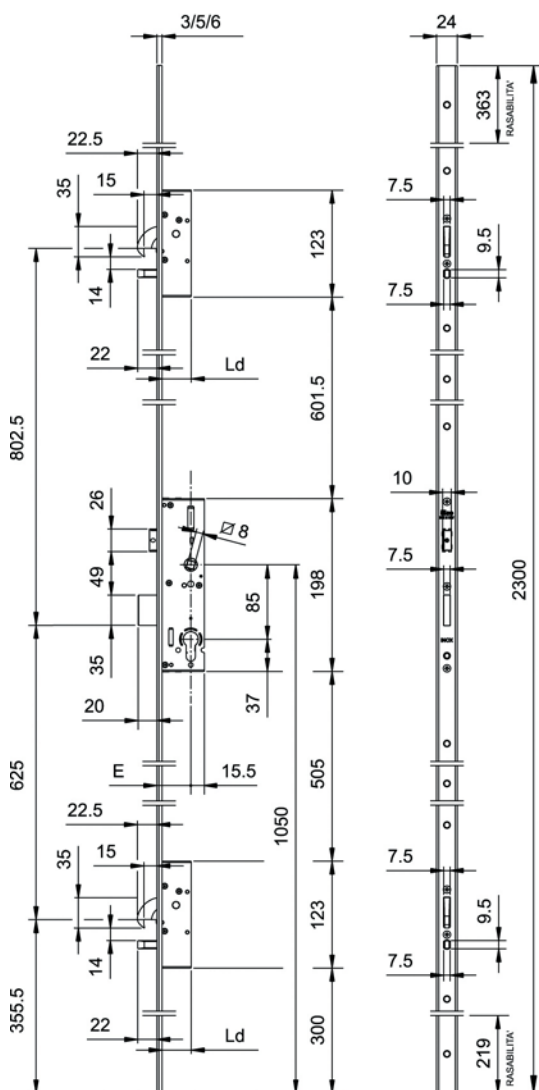
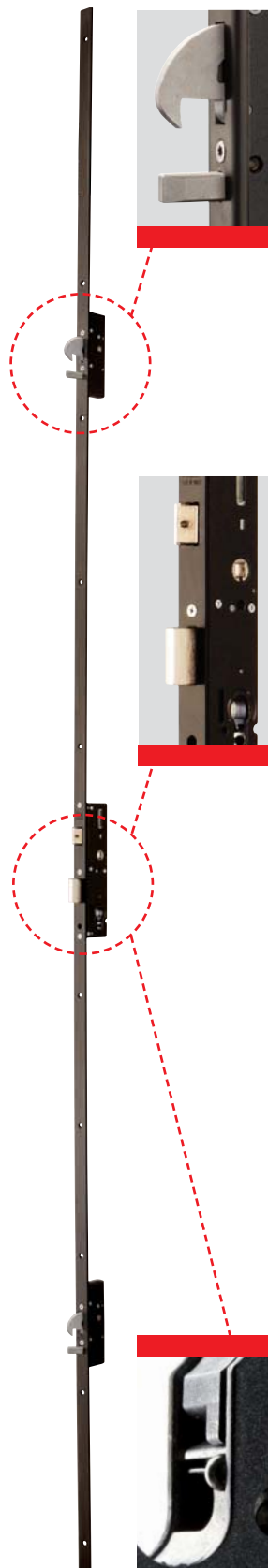

MULTIPOINT mortice lock for metal frames, 3-point locking,  
**ROTATING HOOK DEVIATORS AND SLIDING DEADBOLT LOCK**  
 Central lock, centre distance mm **85**, European profile cylinder.  
 Throw mm 20, **reversible latchbolt**. The latchbolt can be replaced with roller or cap, mm 8 HANDLE FOLLOWER.  
 Closed case for lock and deviators.  
 2 nylon end blocks for U-version. Fixing screws. Instruction sheet.  
 The lock is equipped with a wheel-cam stopping device in case the cylinder is not assembled into the housing of lock.  
**Black painted steel front plate.**

**Accessories to be ordered separately:**  
 Roller for CENTRAL LOCK 040940  
 Cap for DEADBOLT only versions 040950  
 Striking plates  
 Electric strikers



Code  
Status  
Single  
package  
Multiple  
package  
Min. ord.

**Perforza 85 mm centre distance**

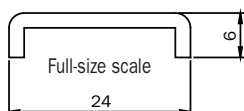

U-front plate mm <b>2300 x 24 x 6</b> in black painted steel. 85 mm centre distance. Backset mm 25 * <b>7255512508</b> D	1	-	1
U-front plate mm <b>2300 x 24 x 6</b> in black painted steel. 85 mm centre distance. Backset mm 30 * <b>7255513008</b> D	1	-	1
U-front plate mm <b>2300 x 24 x 6</b> in black painted steel. 85 mm centre distance. Backset mm 35 * <b>7255513508</b> D	1	-	1
U-front plate mm <b>2300 x 24 x 6</b> in black painted steel. 85 mm centre distance. Backset mm 40 * <b>7255514008</b> D	1	-	1
U-front plate mm <b>2300 x 24 x 6</b> in black painted steel. 85 mm centre distance. Backset mm 45 * <b>7255514508</b> D	1	-	1
U-front plate mm <b>2300 x 24 x 6</b> in black painted steel. 85 mm centre distance. Backset mm 50 * <b>7255515008</b> D	1	-	1

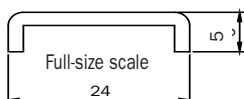

U-front plate mm <b>2300 x 24 x 5</b> in black painted steel. 85 mm centre distance. Backset mm 25 * <b>7255532508</b> D	1	-	1
U-front plate mm <b>2300 x 24 x 5</b> in black painted steel. 85 mm centre distance. Backset mm 30 * <b>7255533008</b> D	1	-	1
U-front plate mm <b>2300 x 24 x 5</b> in black painted steel. 85 mm centre distance. Backset mm 35 * <b>7255533508</b> D	1	-	1
U-front plate mm <b>2300 x 24 x 5</b> in black painted steel. 85 mm centre distance. Backset mm 40 * <b>7255534008</b> D	1	-	1
U-front plate mm <b>2300 x 24 x 5</b> in black painted steel. 85 mm centre distance. Backset mm 45 * <b>7255534508</b> D	1	-	1
U-front plate mm <b>2300 x 24 x 5</b> in black painted steel. 85 mm centre distance. Backset mm 50 * <b>7255535008</b> D	1	-	1

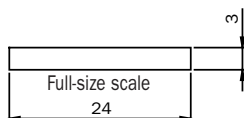

Flat front plate mm <b>2300 x 24 x 3</b> in black painted steel. 85 mm centre distance. Backset mm 25 * <b>7255012508</b> D	1	-	1
Flat front plate mm <b>2300 x 24 x 3</b> in black painted steel. 85 mm centre distance. Backset mm 30 * <b>7255013008</b> D	1	-	1
Flat front plate mm <b>2300 x 24 x 3</b> in black painted steel. 85 mm centre distance. Backset mm 35 * <b>7255013508</b> D	1	-	1
Flat front plate mm <b>2300 x 24 x 3</b> in black painted steel. 85 mm centre distance. Backset mm 40 * <b>7255014008</b> D	1	-	1
Flat front plate mm <b>2300 x 24 x 3</b> in black painted steel. 85 mm centre distance. Backset mm 45 * <b>7255014508</b> D	1	-	1
Flat front plate mm <b>2300 x 24 x 3</b> in black painted steel. 85 mm centre distance. Backset mm 50 * <b>7255015008</b> D	1	-	1

\* Available starting from the second half of 2010



**Perforza 85 mm centre distance**

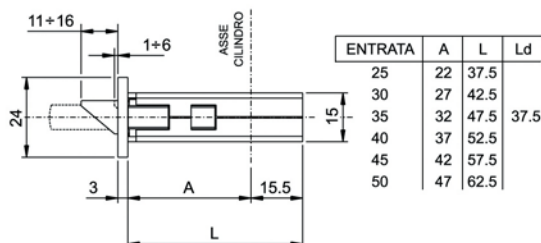
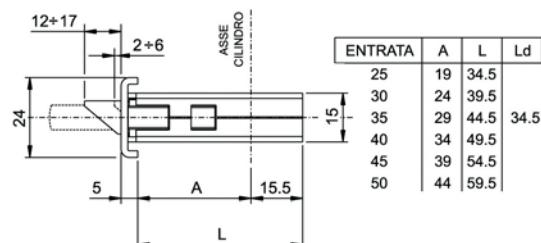
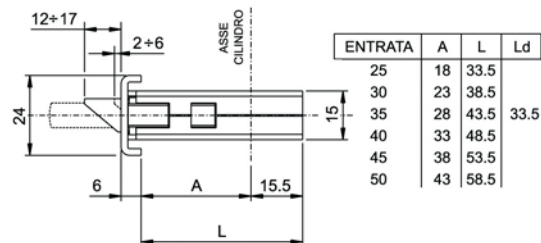
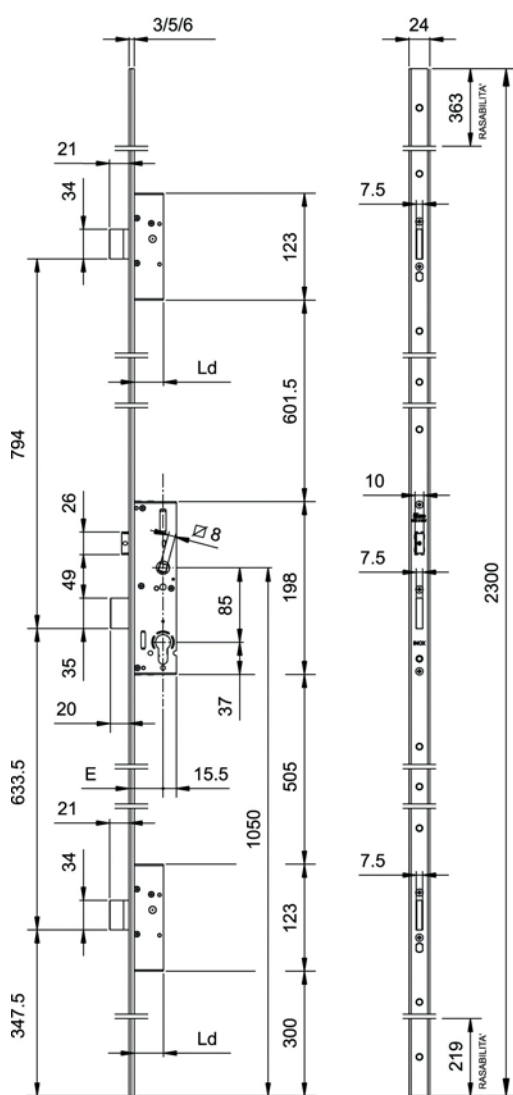
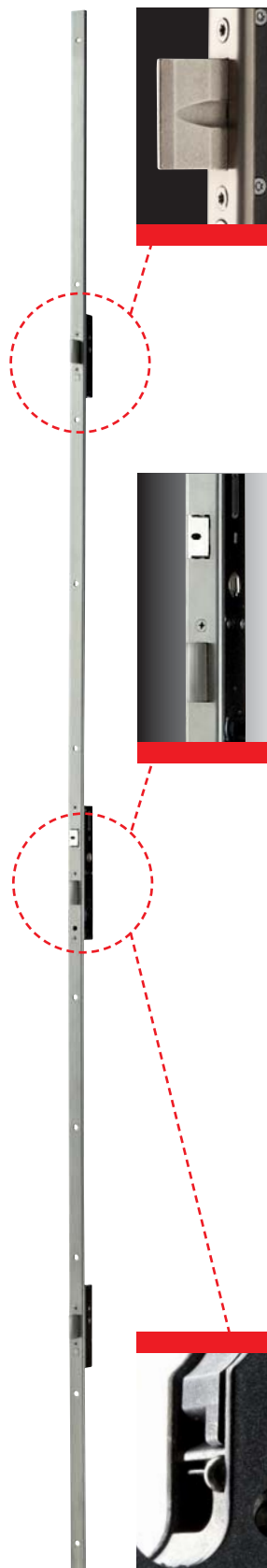

MULTIPOINT mortice lock for metal frames, 3-point locking,

**SLIDING DEADBOLT LOCK AND DEVIATORS.**

Central lock, centre distance mm **85**, profile cylinder.

Throw mm 20, **reversible latchbolt**. The latchbolt can be replaced with roller or cap, mm 8 handle follower.

Closed case for lock and deviators.

2 nylon end blocks for U-version. Fixing screws. Instruction sheet.

The lock is equipped with a wheel-cam stopping device in case the cylinder is not assembled into the housing of lock.

**STAINLESS STEEL front plate.**

**Accessories to be ordered separately:**

Roller FOR CENTRAL LOCK 040940

Cap for DEADBOLT only versions 040950

Striking plates

Electric strikers



Code

Status  
Single  
package

Min. ord.

**Perforza 85 mm centre distance**

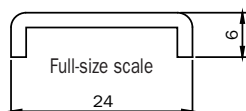

U-front plate mm <b>2300 x 24 x 6</b> in stainless steel. 85 mm centre distance. Backset mm 25 * <b>7235512528</b>	D	1	-	1
U-front plate mm <b>2300 x 24 x 6</b> in stainless steel. 85 mm centre distance. Backset mm 30 <b>7235513028</b>	D	1	-	1
U-front plate mm <b>2300 x 24 x 6</b> in stainless steel. 85 mm centre distance. Backset mm 35 <b>7235513528</b>	D	1	-	1
U-front plate mm <b>2300 x 24 x 6</b> in stainless steel. 85 mm centre distance. Backset mm 40 <b>7235514028</b>	D	1	-	1
U-front plate mm <b>2300 x 24 x 6</b> in stainless steel. 85 mm centre distance. Backset mm 45 <b>7235514528</b>	D	1	-	1
U-front plate mm <b>2300 x 24 x 6</b> in stainless steel. 85 mm centre distance. Backset mm 50 <b>7235515028</b>	D	1	-	1

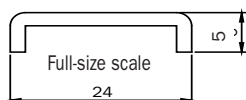

U-front plate mm <b>2300 x 24 x 5</b> in stainless steel. 85 mm centre distance. Backset mm 25 * <b>7235532528</b>	D	1	-	1
U-front plate mm <b>2300 x 24 x 5</b> in stainless steel. 85 mm centre distance. Backset mm 30 <b>7235533028</b>	D	1	-	1
U-front plate mm <b>2300 x 24 x 5</b> in stainless steel. 85 mm centre distance. Backset mm 35 <b>7235533528</b>	D	1	-	1
U-front plate mm <b>2300 x 24 x 5</b> in stainless steel. 85 mm centre distance. Backset mm 40 <b>7235534028</b>	D	1	-	1
U-front plate mm <b>2300 x 24 x 5</b> in stainless steel. 85 mm centre distance. Backset mm 45 <b>7235534528</b>	D	1	-	1
U-front plate mm <b>2300 x 24 x 5</b> in stainless steel. 85 mm centre distance. Backset mm 50 <b>7235535028</b>	D	1	-	1

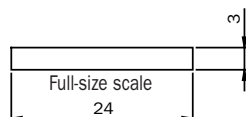

Flat front plate mm <b>2300 x 24 x 3</b> in stainless steel. 85 mm centre distance. Backset mm 25 * <b>7235012528</b>	D	1	-	1
Flat front plate mm <b>2300 x 24 x 3</b> in stainless steel. 85 mm centre distance. Backset mm 30 <b>7235013028</b>	D	1	-	1
Flat front plate mm <b>2300 x 24 x 3</b> in stainless steel. 85 mm centre distance. Backset mm 35 <b>7235013528</b>	D	1	-	1
Flat front plate mm <b>2300 x 24 x 3</b> in stainless steel. 85 mm centre distance. Backset mm 40 <b>7235014028</b>	D	1	-	1
Flat front plate mm <b>2300 x 24 x 3</b> in stainless steel. 85 mm centre distance. Backset mm 45 <b>7235014528</b>	D	1	-	1
Flat front plate mm <b>2300 x 24 x 3</b> in stainless steel. 85 mm centre distance. Backset mm 50 <b>7235015028</b>	D	1	-	1

\* Available starting from the second half of 2010



**Perforza 85 mm centre distance**

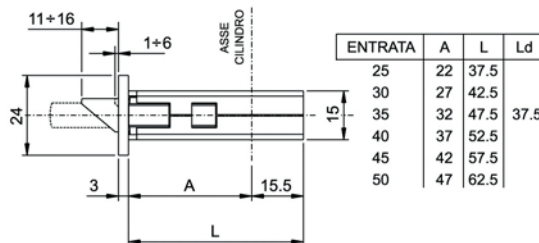
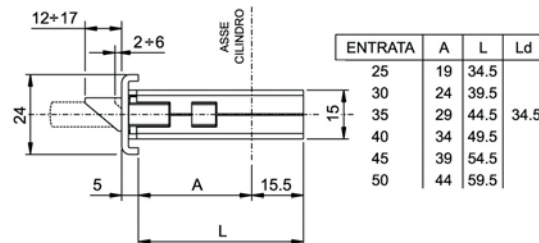
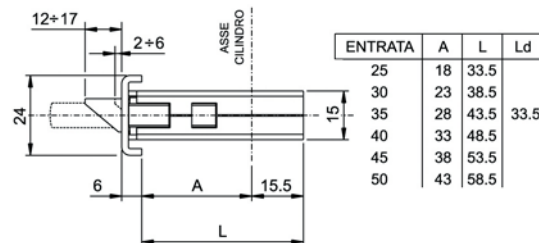
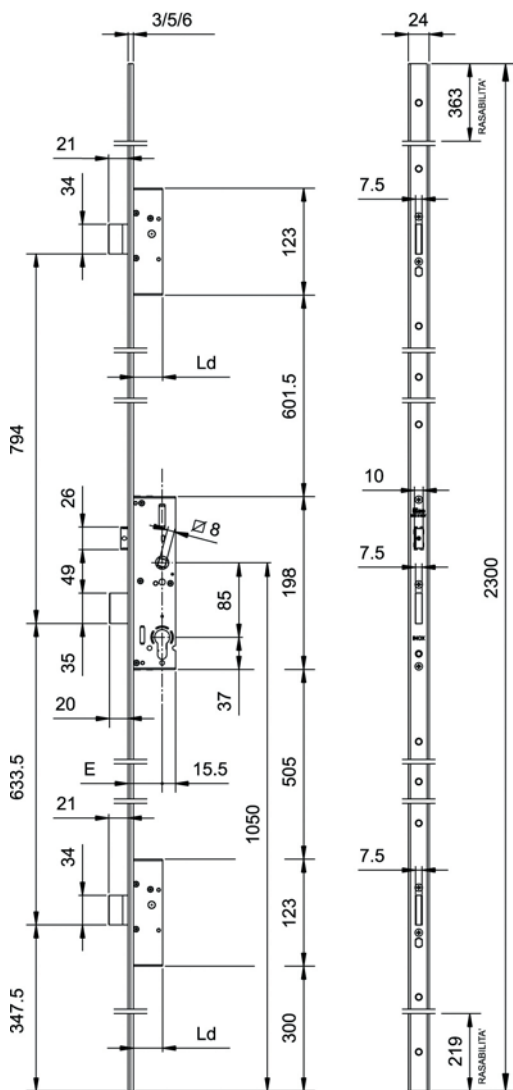
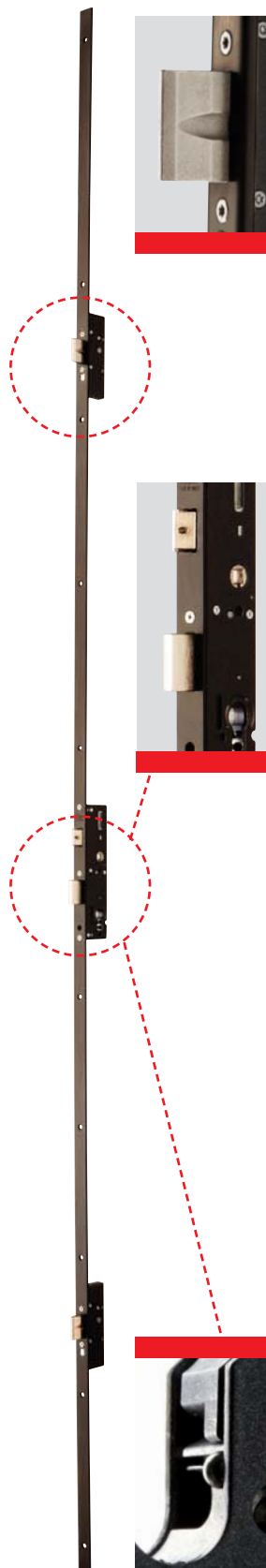

MULTIPOINT mortice lock for metal frames, 3-point locking,

**SLIDING DEADBOLT LOCK AND DEVIATORS.**

Central lock, centre distance mm **85**, profile cylinder.

Throw mm 20, **reversible latchbolt**. The latchbolt can be replaced with roller or cap, mm 8 handle follower.

Closed case for lock and deviators.

2 nylon end blocks for U-version. Fixing screws. Instruction sheet.

The lock is equipped with a wheel-cam stopping device in case the cylinder is not present into the housing of lock.

**Black painted steel front plate.**

**Accessories to be ordered separately:**

Roller FOR CENTRAL LOCK 040940

Cap for DEADBOLT only versions. 040950

Striking plates

Electric strikers



Code  
Status  
Single  
package  
Multiple  
package  
Min. ord.

**Perforza 85 mm centre distance**

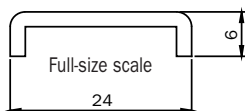

U-front plate mm <b>2300 x 24 x 6</b> in black painted steel. 85 mm centre distance. Backset mm 25* <b>7235512508</b>	D	1	-	1
U-front plate mm <b>2300 x 24 x 6</b> in black painted steel. 85 mm centre distance. Backset mm 30 <b>7235513008</b>	A	1	-	1
U-front plate mm <b>2300 x 24 x 6</b> in black painted steel. 85 mm centre distance. Backset mm 35 <b>7235513508</b>	A	1	-	1
U-front plate mm <b>2300 x 24 x 6</b> in black painted steel. 85 mm centre distance. Backset mm 40 <b>7235514008</b>	C	1	-	1
U-front plate mm <b>2300 x 24 x 6</b> in black painted steel. 85 mm centre distance. Backset mm 45 <b>7235514508</b>	D	1	-	1
U-front plate mm <b>2300 x 24 x 6</b> in black painted steel. 85 mm centre distance. Backset mm 50 <b>7235515008</b>	D	1	-	1

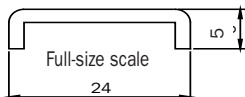

U-front plate mm <b>2300 x 24 x 5</b> in black painted steel. 85 mm centre distance. Backset mm 25* <b>7235532508</b>	D	1	-	1
U-front plate mm <b>2300 x 24 x 5</b> in black painted steel. 85 mm centre distance. Backset mm 30 <b>7235533008</b>	D	1	-	1
U-front plate mm <b>2300 x 24 x 5</b> in black painted steel. 85 mm centre distance. Backset mm 35 <b>7235533508</b>	D	1	-	1
U-front plate mm <b>2300 x 24 x 5</b> in black painted steel. 85 mm centre distance. Backset mm 40 <b>7235534008</b>	D	1	-	1
U-front plate mm <b>2300 x 24 x 5</b> in black painted steel. 85 mm centre distance. Backset mm 45 <b>7235534508</b>	D	1	-	1
U-front plate mm <b>2300 x 24 x 5</b> in black painted steel. 85 mm centre distance. Backset mm 50 <b>7235535008</b>	D	1	-	1

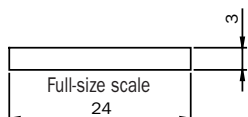

Flat front plate mm <b>2300 x 24 x 3</b> in black painted steel. 85 mm centre distance. Backset mm 25* <b>7235012508</b>	D	1	-	1
Flat front plate mm <b>2300 x 24 x 3</b> in black painted steel. 85 mm centre distance. Backset mm 30 <b>7235013008</b>	A	1	-	1
Flat front plate mm <b>2300 x 24 x 3</b> in black painted steel. 85 mm centre distance. Backset mm 35 <b>7235013508</b>	A	1	-	1
Flat front plate mm <b>2300 x 24 x 3</b> in black painted steel. 85 mm centre distance. Backset mm 40 <b>7235014008</b>	B	1	-	1
Flat front plate mm <b>2300 x 24 x 3</b> in black painted steel. 85 mm centre distance. Backset mm 45 <b>7235014508</b>	D	1	-	1
Flat front plate mm <b>2300 x 24 x 3</b> in black painted steel. 85 mm centre distance. Backset mm 50 <b>7235015008</b>	D	1	-	1

\* Available starting from the second half of 2010



**Perforza 92 mm centre distance**

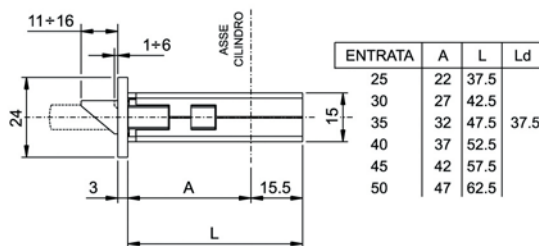
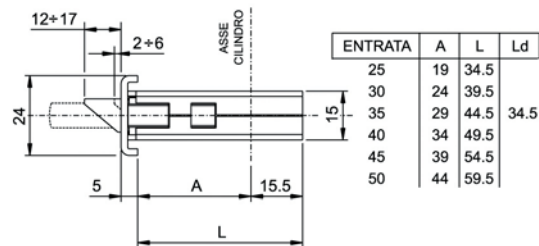
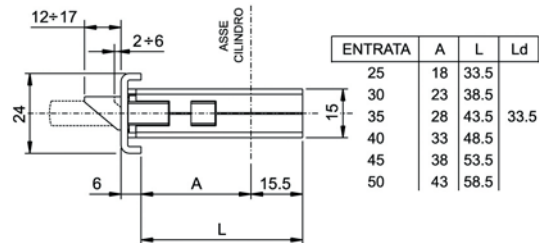
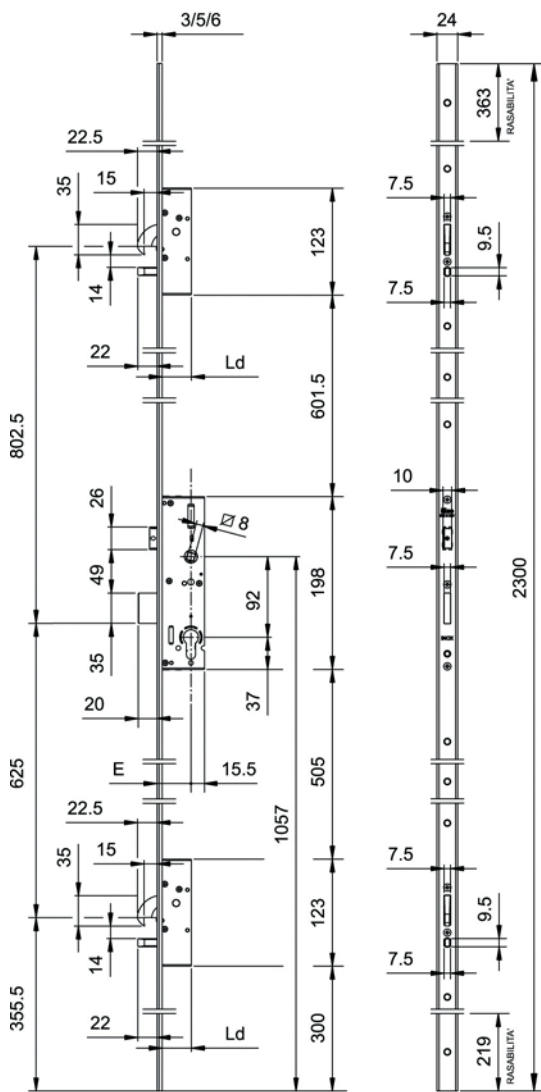
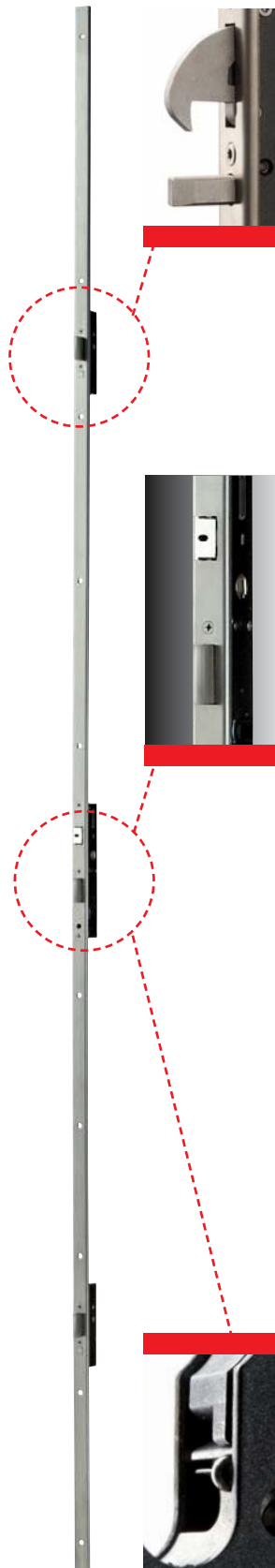

MULTIPOINT mortice lock for metal frames, 3-point locking,  
**ROTATING HOOK DEVIATORS AND SLIDING DEADBOLT LOCK**

Central lock, centre distance mm **92**, profile CYLINDER.

Throw mm 20, **reversible latchbolt**. The latchbolt can be replaced with roller or cap, mm 8 handle follower.

Closed case lock and deviators.

Connection cable, 2 nylon end blocks for U-version. Fixing screws. Instruction sheet.

The lock is equipped with a wheel-cam stopping device in case the cylinder is not present into the housing of lock.

**Stainless steel front plate.**

**Accessories to be ordered separately:**

Roller for central lock 040940

Cap for latchbolt-only versions. 040950

Striking plates

Electric strikers





Code

Min. ord.  
Multiple  
package  
Single  
package  
Status

**Perforza 92 mm centre distance**

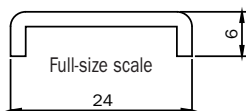

U-front plate mm <b>2300 x 24 x 6</b> in stainless steel. 92 mm centre distance. Backset mm 25*	<b>7252512528</b>	D	1	-	1
U-front plate mm <b>2300 x 24 x 6</b> in stainless steel. 92 mm centre distance. Backset mm 30*	<b>7252513028</b>	D	1	-	1
U-front plate mm <b>2300 x 24 x 6</b> in stainless steel. 92 mm centre distance. Backset mm 35*	<b>7252513528</b>	D	1	-	1
U-front plate mm <b>2300 x 24 x 6</b> in stainless steel. 92 mm centre distance. Backset mm 40*	<b>7252514028</b>	D	1	-	1
U-front plate mm <b>2300 x 24 x 6</b> in stainless steel. 92 mm centre distance. Backset mm 45*	<b>7252514528</b>	D	1	-	1
U-front plate mm <b>2300 x 24 x 6</b> in stainless steel. 92 mm centre distance. Backset mm 50*	<b>7252515028</b>	D	1	-	1

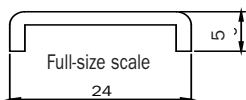

U-front plate mm <b>2300 x 24 x 5</b> in stainless steel. 92 mm centre distance. Backset mm 25*	<b>7252532528</b>	D	1	-	1
U-front plate mm <b>2300 x 24 x 5</b> in stainless steel. 92 mm centre distance. Backset mm 30*	<b>7252533028</b>	D	1	-	1
U-front plate mm <b>2300 x 24 x 5</b> in stainless steel. 92 mm centre distance. Backset mm 35*	<b>7252533528</b>	D	1	-	1
U-front plate mm <b>2300 x 24 x 5</b> in stainless steel. 92 mm centre distance. Backset mm 40*	<b>7252534028</b>	D	1	-	1
U-front plate mm <b>2300 x 24 x 5</b> in stainless steel. 92 mm centre distance. Backset mm 45*	<b>7252534528</b>	D	1	-	1
U-front plate mm <b>2300 x 24 x 5</b> in stainless steel. 92 mm centre distance. Backset mm 50*	<b>7252535028</b>	D	1	-	1

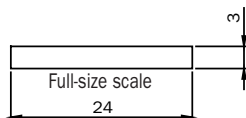

Flat front plate mm <b>2300 x 24 x 3</b> in stainless steel. 92 mm centre distance. Backset mm 25*	<b>7252012528</b>	D	1	-	1
Flat front plate mm <b>2300 x 24 x 3</b> in stainless steel. 92 mm centre distance. Backset mm 30*	<b>7252013028</b>	D	1	-	1
Flat front plate mm <b>2300 x 24 x 3</b> in stainless steel. 92 mm centre distance. Backset mm 35*	<b>7252013528</b>	D	1	-	1
Flat front plate mm <b>2300 x 24 x 3</b> in stainless steel. 92 mm centre distance. Backset mm 40*	<b>7252014028</b>	D	1	-	1
Flat front plate mm <b>2300 x 24 x 3</b> in stainless steel. 92 mm centre distance. Backset mm 45*	<b>7252014528</b>	D	1	-	1
Flat front plate mm <b>2300 x 24 x 3</b> in stainless steel. 92 mm centre distance. Backset mm 50*	<b>7252015028</b>	D	1	-	1

\* Available starting from the second half of 2010



**Perforza 92 mm centre distance**

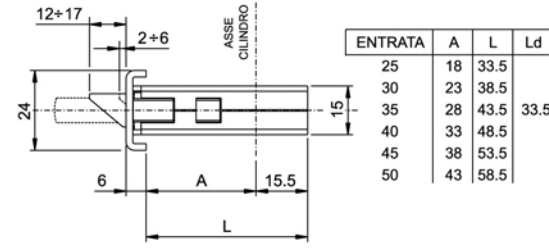
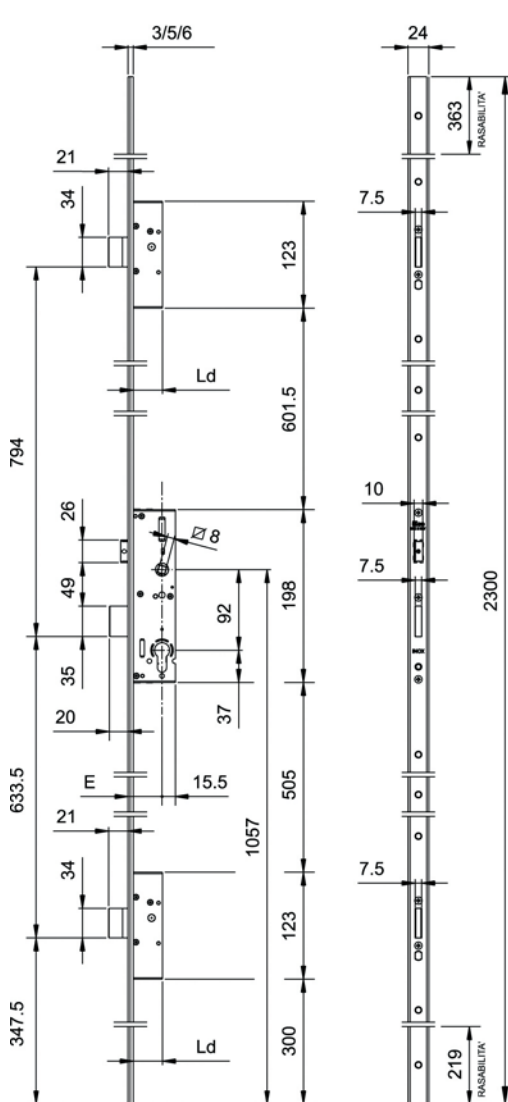
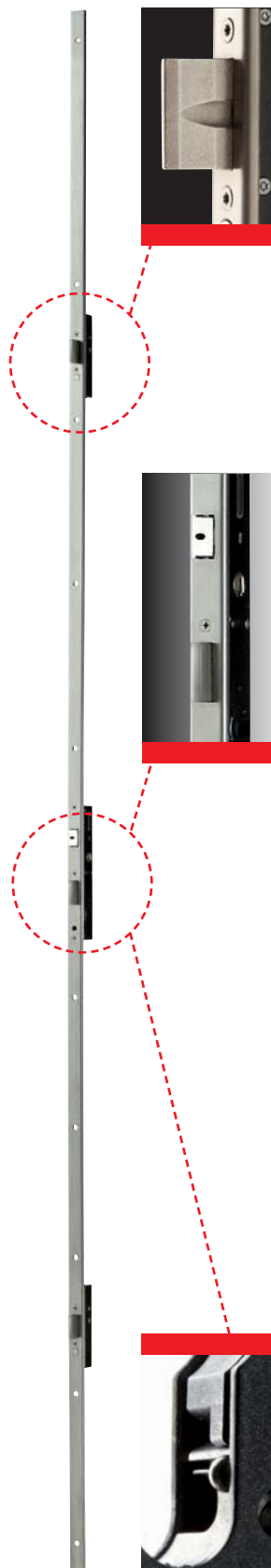

ENTRATA	A	L	Ld
25	18	33.5	33.5
30	23	38.5	
35	28	43.5	
40	33	48.5	
45	38	53.5	
50	43	58.5	

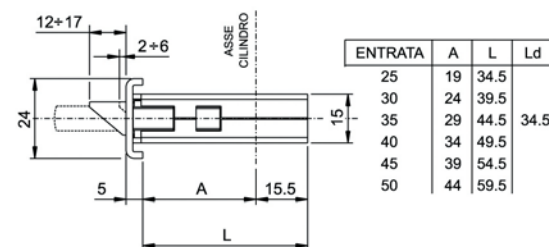

ENTRATA	A	L	Ld
25	19	34.5	34.5
30	24	39.5	
35	29	44.5	
40	34	49.5	
45	39	54.5	
50	44	59.5	

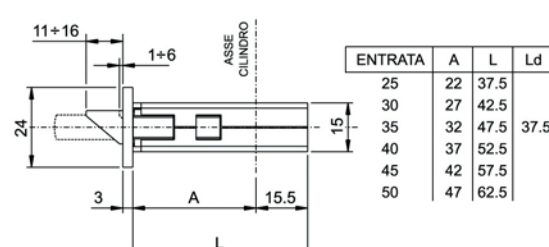

ENTRATA	A	L	Ld
25	22	37.5	37.5
30	27	42.5	
35	32	47.5	
40	37	52.5	
45	42	57.5	
50	47	62.5	

MULTIPOINT mortice lock for metal frames, 3-point locking,

**SLIDING DEADBOLT LOCK AND DEVIATORS.**

Central lock, centre distance mm **92**, profile cylinder .

Throw mm 20, **reversible latchbolt**. The latchbolt can be replaced with roller or cap, mm 8 handle follower.

Closed case for lock and deviators.

2 nylon end blocks for U-version. Fixing screws. Instruction sheet.

The lock is equipped with a wheel-cam stopping device in case the cylinder is not present into the housing of lock.

**Stainless steel front plate.**

**Accessories to be ordered separately:**

Roller FOR CENTRAL LOCK 040940

Cap for DEADBOLT only versions 040950

Striking plates

Electric strikers



Code

Status  
Single  
package  
Multiple  
package  
Min. ord.

## Perforza 92 mm centre distance

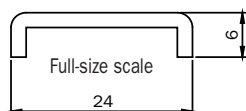

U-front plate mm <b>2300 x 24 x 6</b> in stainless steel. 92 mm centre distance. Backset mm 25 * <b>7232512528</b>	D	1	-	1
U-front plate mm <b>2300 x 24 x 6</b> in stainless steel. 92 mm centre distance. Backset mm 30 <b>7232513028</b>	D	1	-	1
U-front plate mm <b>2300 x 24 x 6</b> in stainless steel. 92 mm centre distance. Backset mm 35 <b>7232513528</b>	D	1	-	1
U-front plate mm <b>2300 x 24 x 6</b> in stainless steel. 92 mm centre distance. Backset mm 40 <b>7232514028</b>	D	1	-	1
U-front plate mm <b>2300 x 24 x 6</b> in stainless steel. 92 mm centre distance. Backset mm 45 * <b>7232514528</b>	D	1	-	1
U-front plate mm <b>2300 x 24 x 6</b> in stainless steel. 92 mm centre distance. Backset mm 50 * <b>7232515028</b>	D	1	-	1

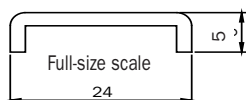

U-front plate mm <b>2300 x 24 x 5</b> in stainless steel. 92 mm centre distance. Backset mm 25 * <b>7232532528</b>	D	1	-	1
U-front plate mm <b>2300 x 24 x 5</b> in stainless steel. 92 mm centre distance. Backset mm 30 <b>7232533028</b>	D	1	-	1
U-front plate mm <b>2300 x 24 x 5</b> in stainless steel. 92 mm centre distance. Backset mm 35 <b>7232533528</b>	D	1	-	1
U-front plate mm <b>2300 x 24 x 5</b> in stainless steel. 92 mm centre distance. Backset mm 40 <b>7232534028</b>	D	1	-	1
U-front plate mm <b>2300 x 24 x 5</b> in stainless steel. 92 mm centre distance. Backset mm 45 * <b>7232534528</b>	D	1	-	1
U-front plate mm <b>2300 x 24 x 5</b> in stainless steel. 92 mm centre distance. Backset mm 50 * <b>7232535028</b>	D	1	-	1

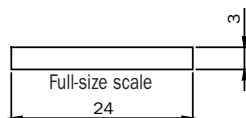

Flat front plate mm <b>2300 x 24 x 3</b> in stainless steel. 92 mm centre distance. Backset mm 25 * <b>7232012528</b>	D	1	-	1
Flat front plate mm <b>2300 x 24 x 3</b> in stainless steel. 92 mm centre distance. Backset mm 30 <b>7232013028</b>	D	1	-	1
Flat front plate mm <b>2300 x 24 x 3</b> in stainless steel. 92 mm centre distance. Backset mm 35 <b>7232013528</b>	D	1	-	1
Flat front plate mm <b>2300 x 24 x 3</b> in stainless steel. 92 mm centre distance. Backset mm 40 <b>7232014028</b>	D	1	-	1
Flat front plate mm <b>2300 x 24 x 3</b> in stainless steel. 92 mm centre distance. Backset mm 45 * <b>7232014528</b>	D	1	-	1
Flat front plate mm <b>2300 x 24 x 3</b> in stainless steel. 92 mm centre distance. Backset mm 50 * <b>7232015028</b>	D	1	-	1

\* Available starting from the second half of 2010



Code

Status

Single  
package

Multiple  
package

Min. ord.

## Perforza Accessories

### Accessories for central lock to be ordered separately



ROLLER KIT for PERFORMA, WITH NYLON INSERTS

It can replace the latchbolt

For lock backset mm 25, 30, 35, 40, 45, 50

**040940** A 10 - 10



CAP KIT PERFORMA

It can replace the latchbolt for DEADBOLTS only version.

For lock backset mm 25, 30, 35, 40, 45, 50

**040950** B 10 - 10



Code

Status

Single  
package

Multiple  
package

Min. ord.

**Perforza Options**

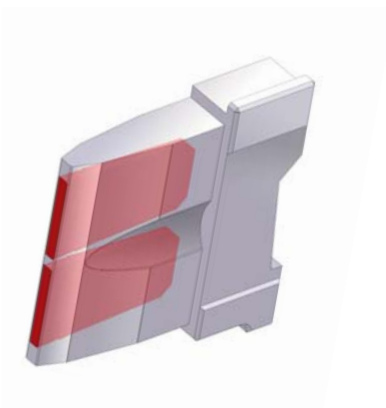
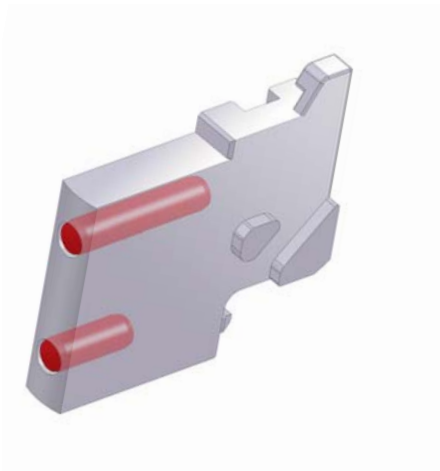

**DEVIATORS AND LOCK WITH SLIDING DEADBOLTS, STAINLESS STEEL FRONT PLATE.**

**ANTI-SAW DEADBOLTS REINFORCED. 85 mm centre distance LOCK**

U-front plate mm <b>2300 x 24 x 6</b> in stainless steel. 85 mm centre distance. Backset mm **	<b>723651**28</b>	D	1	-	1
U-front plate mm <b>2300 x 24 x 5</b> in stainless steel. 85 mm centre distance. Backset mm **	<b>723653**28</b>	D	1	-	1
Flat front plate mm <b>2300 x 24 x 3</b> in stainless steel. 85 mm centre distance. Backset mm **	<b>723601**28</b>	D	1	-	1

**ANTI-SAW DEADBOLTS REINFORCED. 92 mm centre distance LOCK**

U-front plate mm <b>2300 x 24 x 6</b> in stainless steel. 92 mm centre distance. Backset mm **	<b>723351**28</b>	D	1	-	1
U-front plate mm <b>2300 x 24 x 5</b> in stainless steel. 92 mm centre distance. Backset mm **	<b>723353**28</b>	D	1	-	1
Flat front plate mm <b>2300 x 24 x 3</b> in stainless steel. 92 mm centre distance. Backset mm **	<b>723301**28</b>	D	1	-	1

\*\* = Backset mm 25/30/35/40/45/50

Availability and delivery to be agreed

**For locks for metal frames  
series 72\***



Code

Status  
Single  
package

Min. ord.

**Perforza**

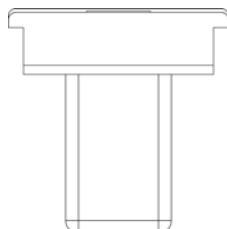

Full-size scale

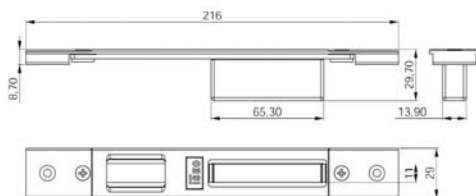

- ALCAN abithal Keeper Porta 53-60 / Abithal Keeper Porta 61-68  
Abithal Porta / Winner Porta
- ALCOA fo 12 Blindato / Formula F40 Porta / Formula F40 Tt  
Porta
- Formula F50 Porta / Formula F50 Tt Porta / Formula F60 Tt Porta  
Plana 1 Anta / Plana 2 Ante
- ALLCO all.Co 5 Porta / All.Co 5 Tt Porta / Export 50 Porta  
Export 50 Tt Porta / Sicurblin 65
- ALNOR montreal Porta
- ALU-K alubindo / N 45 Porta / N 53 Porta / N 55 Tt Porta  
N 62 Tt Porta
- ALU-MEC synthesis 57 Porta / Synthesis 60Tt Porta
- ALUSUISSE elsec 2000 Porta 59 / Alsec 2000 Porta 69
- BODEGA extrabind 70
- DOMAL domal Break 52 Porta / Domal Break 70 Porta  
Domal Security Porta / Domal Shops Porta / Domal Stopper Pg  
Porta
- ESA blindal 60 Porta 1 Anta / Blindal 60 Porta 2 Ante  
Blindal 70 Porta 1 Anta / Blindal 70 Porta 2 Ante
- FRESIA global 48 Porta
- INDIVEST alpha 445 Porta 2 Ante
- METRA nc 45 International Porta / Nc 45 Superthermic Porta  
Nc 55 International Porta / Nc 68 Superthermic Porta  
Nuovo Nc 50 Porta / Superblindo
- NEW TEC new Tec 50 Porta Complanare  
New Tec 52 Tt Porta Complanare / New Tec 68 Tt Porta  
Complanare
- OCMAfo 60 Tt Porta / Sv 47 Porta 1 Anta / Sv 47 Porta 2 Ante  
Sv 62 Porta 1 Anta / Sv 62 Porta 2 Ante / Sv 62 Tt Porta 1 Anta  
Sv 62 Tt Porta 2 Ante
- PASSERINI ekip Blindo / Ekip Maastricht 53 Porta 1 Anta  
Ekip Maastricht 53 Porta 2 Ante  
Ekip Maastricht Th 60 Porta 1 Anta  
Ekip Maastricht Th 60 Porta 2 Ante  
Ekip Maastricht Th 68 Porta 1 Anta  
Ekip Maastricht Th 68 Porta 2 Ante / Ekip Thermo 53 Porta
- PROFILATI "Pe" "Eku 53" "Porta"  
"Pe" "Eku 64 Tt" "Porta"  
"Pe" "Eku 72 Tt" "Porta"
- SCHÜCO royal 78 St Blindato / Royal S 50 N / Royal S 55 Tt  
Royal S 65 Tt
- WICONA 160A / L70A

**ADJUSTABLE** closed striking plate for **CENTRAL LOCK**  
PERFORMA, all versions. Black-painted steel.

Flat front plate **29x216**  
with vertical adjustment from 7 to 12 mm  
and horizontal adjustment  $\pm$  mm 2.

**038620** A 10 - 10

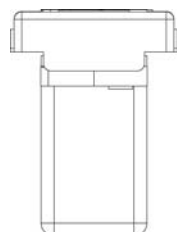

Full-size scale

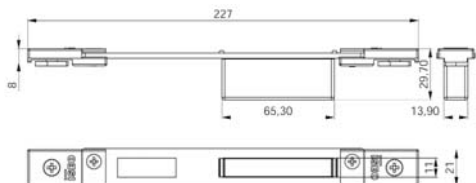

- ALCAN abithal Cristal / Abithal Keeper Porta C.E. / Winner Finestra
- ALCOA fo 12 Ga / Europa Ga / Fo 12 T.T. / R 35 Reversible  
R 35 Sormonto
- ALLCO export 40 Finestra / Export 45 Tt Finestra / Export 50  
Finestra
- Export 50 Tt Finestra / Final 40 Finestra / Sicurblin C.E.
- ALU-MEC synthesis 45 Finestra / Synthesis 57 Finestra  
Synthesis 60 Tt Finestra
- ALUSUISSE elsec 2000 Finestra 59 / Alsec 2000 Finestra 69
- BODEGA bga 50 / New Bt 60
- DOMAL domal Break 52 Finestra / Domal Break 70 Finestra  
Domal Stopper Pg Finestra
- EQUIPE sistema 8000 G.A. Finestra 1 Anta  
Sistema 8000 G.A. Finestra 2 Ante / Sistema 8000 Tt Finestra 1  
Anta  
Sistema 8000 Tt Finestra 2 Ante
- ESA isola Porta
- ESEDRA ga 53 Porta / Tt 63 Porta / Tt 75 Porta
- INDIVEST gold 400 Complanare / Gold 400 Sormonto  
Gold 500 Complanare / Gold 500 Sormonto / Gold 600 Complanare  
Gold 600 Sormonto
- METRA nc 45 International Finestra / Nc 45 Superthermic Finestra  
Nc 55 International Finestra / Nc 68 Superthermic Finestra  
Nuovo Nc 40 Sorm. 2 Ante Con Riporto / Nuovo Nc 40 Sormonto 1  
Anta
- MORELLI ma 8300
- OCMA fo 47 Finestra / Fc 55 Finestra / Fc 60 Tt Finestra
- PASSERINI ekip 40 Evoluzione 1 Anta / Ekip 40 Evoluzione 2 Ante  
Ekip 40 Sormonto 1 Anta / Ekip 40 Sormonto 2 Ante  
Ekip Maastricht 53 Finestra / Ekip Maastricht Th 60 Finestra  
Ekip Maastricht Th 68 Finestra
- PROFILATI "Pe" "Eku 53" "Finestra" / "Pe" "Eku 64 Tt" "Finestra"  
"Pe" "Eku 72 Tt" "Finestra" / Sistema 1 Pe 40 Comp./Est. 1 Anta  
Sistema 1 Pe 40 Sormonto 1 Anta / Sistema 1 Pe 50 Comp./Est. 1  
Anta  
Sistema 1 Pe 50 Sormonto 1 Anta

**ADJUSTABLE** closed striking plate for **CENTRAL LOCK**  
PERFORMA, all versions. Black-painted steel.

Flat front plate **22x227**  
with vertical adjustment through threaded plates  
and horizontal adjustment  $\pm$  mm 9.

**038621** A 10 - 10

**For locks for metal frames  
series 72\***



Code

Status  
Single  
package

Min. ord.

**Perforza**



Full-size scale

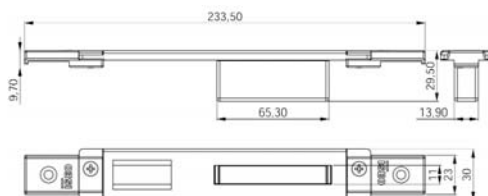

ALCOA alubind / R 40 Reversibile 1 Anta / R 40 Reversibile 2 Anta  
R 40 Sormonto 1 Anta / R 40 Sormonto 2 Ante  
R 50 Sormonto 1 Anta / R 50 Sormonto 2 Ante  
R 50 Tt Sormonto 1 Anta / R 50 Tt Sormonto 2 Ante  
R 60 Tt Complanare  
ALL.CO all.Co 5 Reversibile / All.Co 5 Sormonto / Ites P4 Sormonto  
ALU-K n 45 Reversibile  
ESA giuntall Porta  
FRESIA global 41 Complanare / Global 41 Sormonto  
Global 48 Complanare / Global 48 Sormonto / Global 70 Taglio  
Termico  
METRA nuovo Nc 50 Sormonto 1 Anta / Nuovo Nc 50 Sormonto 2 Ante  
New Tecnew Tec 50 Porta Sormonto / New Tec 52 Tt Porta Sormonto  
New Tec 60 Tt Porta Sormonto / New Tec 68 Tt Porta Sormonto  
PASSERINI ekip 50 Sormonto 1 Anta / Ekip 50 Sormonto 2 Ante

**ADJUSTABLE** closed striking plate for **CENTRAL LOCK** PERFORMA, all versions. Black-painted zamak.

Flat front plate **30x5,1x233,5**  
horizontal adjustment  $\pm 9$  mm

**038622** B 10 - 10

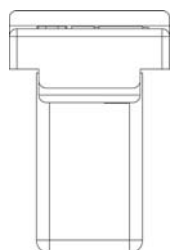

Full-size scale

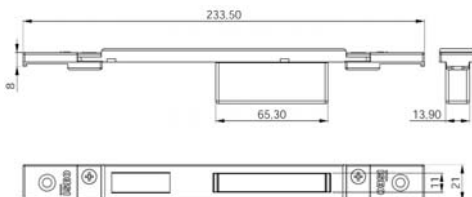

ALL.CO all.Co 5 Complanare / Ites P4 Complanare  
ALNOR blindo Block / Montreal G.A.  
ALU-K n 53 Complanare / N 55 Tt Complanare  
ESA giuntall Complanare  
INDINVEST alpha 255 Complanare / Alpha 370 Tt Complanare  
Alpha 445 Finestra / Alpha 445 Porta 1 Anta  
Alpha 658 Tt Complanare / Alpha Blitz 2000  
Alpha Globo 45 / Alpha Globo 55  
METRA nuovo Nc 40 Complanare / Nuovo Nc 40 Sormonto 2 Ante  
Nuovo Nc 50 Complanare  
PASSERINI ekip 40 Complanare 1 Anta  
Ekip 40 Complanare 2 Ante  
Ekip 50 Complanare 1 Anta / Ekip 50 Complanare 2 Ante  
Ekip Thermo 53 Finestra 1 Anta / Ekip Thermo 53 Finestra 2 Ante  
Ekip Thermo 58 Finestra 1 Anta / Ekip Thermo 58 Finestra 2 Ante  
PROFILATI sistema 1 Pe 40 Comp./Est. 2 Ante  
Sistema 1 Pe 40 Sormonto 2 Ante / Sistema 1 Pe 50 Comp.  
Est. 2 Ante  
Sistema 1 Pe 50 Sormonto 2 Ante

**ADJUSTABLE** closed striking plate for **CENTRAL LOCK** PERFORMA, all versions. Black-painted zamak.

Flat front plate **21x8x233,5**  
horizontal adjustment  $\pm 9$  mm

**038623** D 10 - 10

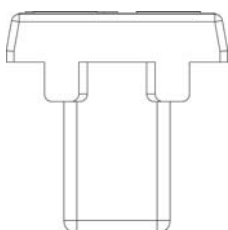

Full-size scale

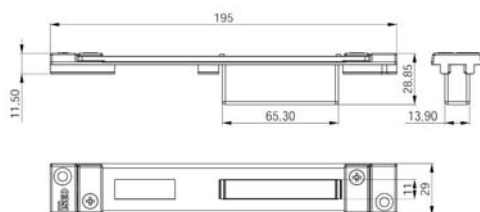

ALCOA alubind / R 40 Reversibile 1 Anta  
R 40 Reversibile 2 Ante  
R 40 Sormonto 1 Anta / R 40 Sormonto 2 Ante  
R 50 Sormonto 1 Anta / R 50 Sormonto 2 Ante  
R 50 Tt Sormonto 1 Anta / R 50 Tt Sormonto 2 Ante  
R 60 Tt Complanare

**ADJUSTABLE** closed striking plate for **CENTRAL LOCK** PERFORMA, all versions. Black-painted steel.

Flat front plate **29x195**  
horizontal adjustment  $\pm 13$  mm

**038624** A 10 - 10

**For locks for metal frames  
series 72\***



Code

Status

Single  
package

Multiple  
package

Min. ord.

**Perforza**

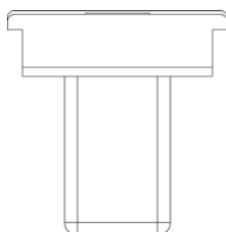

Full-size scale

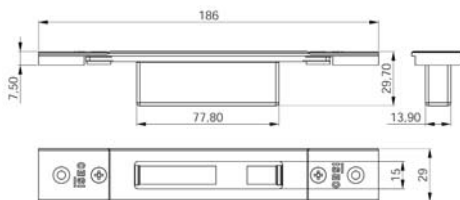

- ALCAN abithal Keeper Porta 53-60 / Abithal Keeper Porta 61-68  
Abithal Porta / Winner Porta
- ALCOA fb 12 Blindato / Formula F40 Porta / Formula F40 Tt Porta  
Formula F50 Porta / Formula F50 Tt Porta / Formula F60 Tt Porta  
Plana 1 Anta / Plana 2 Anta
- ALLCO all.Co 5 Porta / All.Co 5 Tt Porta / Export 50 Porta  
Export 50 Tt Porta / Sicurlin 65
- ALNOR montreal Porta
- ALU-K alublindo / N 45 Porta / N 53 Porta / N 55 Tt Porta  
N 62 Tt Porta
- ALU-MEC synthesis 57 Porta / Synthesis 60Tt Porta
- ALUSUISSE alsec 2000 Porta 59 / Alsec 2000 Porta 69
- BODEGA extrablind 70
- DOMAL domal Break 52 Porta / Domal Break 70 Porta  
Domal Security Porta / Domal Shops Porta / Domal Stopper Pg Porta
- ESA blindal 60 Porta 1 Anta / Blindal 60 Porta 2 Anta  
Blindal 70 Porta 1 Anta / Blindal 70 Porta 2 Anta
- FRESIA global 48 Porta
- INDIVEST alpha 445 Porta 2 Anta
- METRA nc 45 International Porta / Nc 45 Superthermic Porta  
Nc 55 International Porta / Nc 68 Superthermic Porta  
Nuovo Nc 50 Porta / Superblindo
- NEW TEC new Tec 50 Porta Complanare  
New Tec 52 Tt Porta Complanare / New Tec 68 Tt Porta Complanare
- OCMAfc 60 Tt Porta / Sv 47 Porta 1 Anta / Sv 47 Porta 2 Anta  
Sv 62 Porta 1 Anta / Sv 62 Porta 2 Anta / Sv 62 Tt Porta 1 Anta  
Sv 62 Tt Porta 2 Anta
- PASSERINI ekip Blindo / Ekip Maastricht 53 Porta 1 Anta  
Ekip Maastricht 53 Porta 2 Anta / Ekip Maastricht Th 60 Porta 1 Anta  
Ekip Maastricht Th 60 Porta 2 Anta  
Ekip Maastricht Th 68 Porta 1 Anta  
Ekip Maastricht Th 68 Porta 2 Anta / Ekip Thermo 53 Porta
- PROFILATI "Pe" "Eku 53" Porta  
"Pe" "Eku 64 Tt" Porta  
"Pe" "Eku 72 Tt" Porta
- SCHÜCO royal 78 St Blindato / Royal S 50 N / Royal S 55 Tt  
Royal S 65 Tt
- WICONA i60A / L70A

**ADJUSTABLE closed striking plate for DEVIATORS**

PERFORMA. Black-painted steel.

Flat front plate **29x186**

with vertical adjustment from 7 to 12 mm

and horizontal adjustment  $\pm 2$ mm

**038720** A 10 - 10

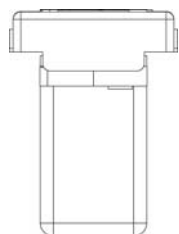

Full-size scale

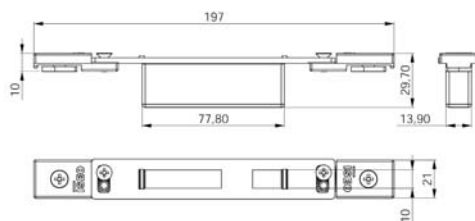

- ALCAN abithal Cristal / Abithal Keeper Porta C.E. / Winner Finestra
- ALCOA fo 12 Ga / Europa Ga / Fo 12 T.T. / R 35 Reversibile  
R 35 Somonto
- ALLCO export 40 Finestra / Export 45 Tt Finestra / Export 50  
Finestra  
Export 50 Tt Finestra / Final 40 Finestra / Sicurlin C.E.
- ALU-MEC synthesis 45 Finestra / Synthesis 57 Finestra  
Synthesis 60 Tt Finestra
- ALUSUISSE alsec 2000 Finestra 59 / Alsec 2000 Finestra 69
- BODEGA lga 50 / New Bt 60
- DOMAL domal Break 52 Finestra / Domal Break 70 Finestra  
Domal Stopper Pg Finestra
- EQUIPE sistema 8000 G.A. Finestra 1 Anta  
Sistema 8000 G.A. Finestra 2 Anta / Sistema 8000 Tt Finestra 1  
Anta  
Sistema 8000 Tt Finestra 2 Anta
- ESA Isola Porta
- ESEDRA ga 53 Porta / Tt 63 Porta / Tt 75 Porta
- INDIVEST gold 400 Complanare / Gold 400 Somonto  
Gold 500 Complanare / Gold 500 Somonto / Gold 600  
Complanare  
Gold 600 Somonto
- METRA nc 45 International Finestra / Nc 45 Superthermic Finestra  
Nc 55 International Finestra / Nc 68 Superthermic Finestra  
Nuovo Nc 40 Sorm. 2 Anta Con Riporto  
Nuovo Nc 40 Somonto 1 Anta
- MORELLI ma 8300
- OCMA fo 47 Finestra / Fo 55 Finestra / Fo 60 Tt Finestra
- PASSERINI ekip 40 Evoluzione 1 Anta / Ekip 40 Evoluzione 2 Anta  
Ekip 40 Somonto 1 Anta / Ekip 40 Somonto 2 Anta  
Ekip Maastricht 53 Finestra / Ekip Maastricht Th 60 Finestra  
Ekip Maastricht Th 68 Finestra
- PROFILATI "Pe" "Eku 53" Finestra / "Pe" "Eku 64 Tt" Finestra  
"Pe" "Eku 72 Tt" Finestra / Sistema 1 Pe 40 Comp./Est. 1 Anta  
Sistema 1 Pe 40 Somonto 1 Anta / Sistema 1 Pe 50 Comp./Est.  
1 Anta  
Sistema 1 Pe 50 Somonto 1 Anta

**ADJUSTABLE closed striking plate for DEVIATORS**

PERFORMA, Black-painted steel.

Flat front plate **22x197**

with vertical adjustment through threaded plates

and horizontal adjustment  $\pm 9$  mm

**038721** A 10 - 10



**For locks for metal frames series 72\***



Code

Status  
Single package

Min. ord.

**Perforza**



Full-size scale

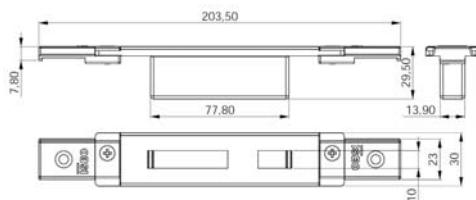

**ADJUSTABLE** closed striking plate for **DEVIATORS**

PERFORMA. Black-painted zamak.

Flat front plate **30x5,5x203,5**

horizontal adjustment  $\pm 9$  mm

ALCOA alubind / R 40 Reversibile 1 Anta / R 40 Reversibile 2 Anta  
R 40 Sormonto 1 Anta / R 40 Sormonto 2 Ante  
R 50 Sormonto 1 Anta / R 50 Sormonto 2 Ante  
R 50 Tt Sormonto 1 Anta / R 50 Tt Sormonto 2 Ante  
R 60 Tt Complanare  
ALL.CO all.Co 5 Reversibile / All.Co 5 Sormonto / ltes P4 Sormonto  
ALU-K n 45 Reversibile  
ESA giuntall Porta  
FRESIA global 41 Complanare / Global 41 Sormonto  
Global 48 Complanare / Global 48 Sormonto / Global 70 Taglio Termico  
METRA nuovo Nc 50 Sormonto 1 Anta / Nuovo Nc 50 Sormonto 2 Ante  
New Tecnew Tec 50 Porta Sormonto / New Tec 52 Tt Porta Sormonto  
New Tec 60 Tt Porta Sormonto / New Tec 68 Tt Porta Sormonto  
PASSERINI ekip 50 Sormonto 1 Anta / Ekip 50 Sormonto 2 Ante

**038722** D 10 - 10

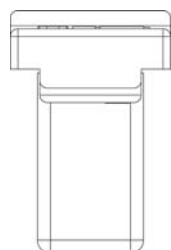

Full-size scale

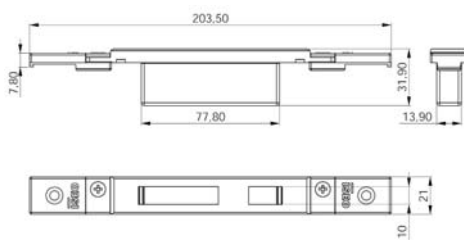

**ADJUSTABLE** closed striking plate for **DEVIATORS**

PERFORMA. Black-painted zamak.

Flat front plate **21x8x203,5**

horizontal adjustment  $\pm 9$  mm

ALL.CO all.Co 5 Complanare / ltes P4 Complanare  
ALNOR blindo Block / Montreal G.A.  
ALU-K n 53 Complanare / N 55 Tt Complanare  
ESA giuntall Complanare  
INDINVEST alpha 255 Complanare / Alpha 370 Tt Complanare  
Alpha 445 Finestra / Alpha 445 Porta 1 Anta  
Alpha 658 Tt Complanare / Alpha Blitz 2000  
Alpha Globo 45 / Alpha Globo 55  
METRA nuovo Nc 40 Complanare / Nuovo Nc 40 Sormonto 2 Ante  
Nuovo Nc 50 Complanare  
PASSERINI ekip 40 Complanare 1 Anta / Ekip 40 Complanare 2 Ante  
Ekip 50 Complanare 1 Anta / Ekip 50 Complanare 2 Ante  
Ekip Thermo 53 Finestra 1 Anta / Ekip Thermo 53 Finestra 2 Ante  
Ekip Thermo 58 Finestra 1 Anta / Ekip Thermo 58 Finestra 2 Ante  
PROFILATI sistema 1 Pe 40 Comp./Est. 2 Ante  
Sistema 1 Pe 40 Sormonto 2 Ante  
Sistema 1 Pe 50 Comp./Est. 2 Ante  
Sistema 1 Pe 50 Sormonto 2 Ante

**038723** D 10 - 10

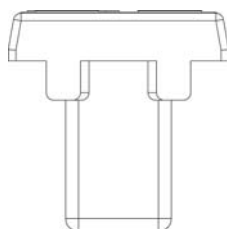

Full-size scale

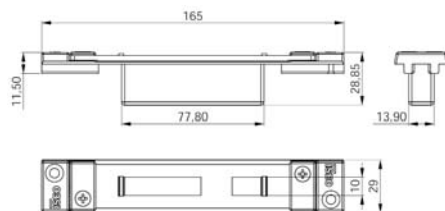

**ADJUSTABLE** closed striking plate for **DEVIATORS**

PERFORMA. Black-painted steel.

Flat front plate **29x165**

horizontal adjustment  $\pm 13$  mm

ALCOA alubind / R 40 Reversibile 1 Anta  
R 40 Reversibile 2 Ante  
R 40 Sormonto 1 Anta / R 40 Sormonto 2 Ante  
R 50 Sormonto 1 Anta / R 50 Sormonto 2 Ante  
R 50 Tt Sormonto 1 Anta / R 50 Tt Sormonto 2 Ante  
R 60 Tt Complanare

**038724** A 10 - 10

**For locks for metal frames series 72\***



Code

Min. ord.  
Multiple package  
Single package  
Status

**Perforza**



Full-size scale

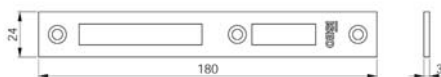

**ALCOA** Fb 12 Blindato  
Fb 12 Trad./Revamping  
Gr 9  
Plana 1 Anta  
**ESA** Blindal 60 Porta 1 Anta  
Blindal 60 Porta 2 Ante  
**ESA** Blindal 70 Porta 1 Anta  
Blindal 70 Porta 2 Ante  
**SCHUCO** Royal S 50 N  
Royal S 55 Tt  
Royal S 65 Tt

Striking plates

**FOR CENTRAL LOCK PERFORMA.**

Stainless steel. Flat front plate **24x3x180.**

**038230** C 10 - 10

Nickel plated. Flat front plate **24x3x180.**

**038230H3** D 10 - 10



Full-size scale

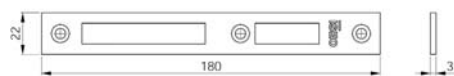

**Alcan** Abithal Cristal / Abithal Keeper Porta C.E.  
Winner Finestra  
**Alcoa** Fb 12 Ga / Europa Ga / Fb 12 T.T. / R 35 Reversibile  
R 35 Sormonto  
**All.Co** Export 40 Finestra / Export 50 Finestra  
Export 50 Tt Finestra / Final 40 Finestra / Sicurbilin C.E.  
**Alu-mec** Synthesis 45 Finestra / Synthesis 57 Finestra  
Synthesis 60 Tt Finestra  
**Alusuisse** Alsec 2000 Finestra 59 / Alsec 2000 Finestra 69  
**Bodega** Bga 50 / New Bt 60  
**Domal** Domal Break 52 Finestra / Domal Break 70 Finestra  
Domal Stopper Pg Finestra  
**Equipe** Sistema 8000 G.A. Finestra 1 Anta  
Sistema 8000 G.A. Finestra 2 Ante  
**Esa** Isola Porta  
**Esedra** Ga 53 Porta / Ga 53 Porta / Tt 63 Porta / Tt 63 Porta  
Tt 75 Porta / Tt 75 Porta  
**Indinvest** Gold 400 Complanare / Gold 400 Sormonto  
Gold 500 Complanare / Gold 500 Sormonto  
Gold 600 Complanare / Gold 600 Sormonto  
**Metra** Nc 45 International Finestra / Nc 45 Superthermic Finestra  
Nc 55 International Finestra / Nc 68 Superthermic Finestra  
**Morelli** Ma 8300  
**Ocma** Fc 47 Finestra / Fc 55 Finestra / Fc 60 Tt Finestra  
**Passerini** Ekip 40 Evoluzione 2 Ante / Ekip 40 Sormonto 2 Ante  
Ekip 50 Sormonto 2 Ante / Ekip Maastricht 53 Finestra  
Ekip Maastricht Th 60 Finestra / Ekip Maastricht Th 68 Finestra  
**Profilati** "Pe" "Eku 53" Finestra / "Pe" "Eku 64 Tt" Finestra  
"Pe" "Eku 72 Tt" Finestra"

Striking plates

**FOR CENTRAL LOCK PERFORMA.**

Stainless steel. Flat front plate **22x3x180.**

**038231** C 10 - 10



Full-size scale



**Alcan** Abithal Cristal / Abithal Keeper Porta C.E.  
Winner Finestra  
**Alcoa** Fb 12 Ga / Europa Ga / Fb 12 T.T. / R 35 Reversibile  
R 35 Sormonto  
**All.Co** Export 40 Finestra / Export 50 Finestra  
Export 50 Tt Finestra / Final 40 Finestra / Sicurbilin C.E.  
**Alu-mec** Synthesis 45 Finestra / Synthesis 57 Finestra  
Synthesis 60 Tt Finestra  
**Alusuisse** Alsec 2000 Finestra 59 / Alsec 2000 Finestra 69  
**Bodega** Bga 50 / New Bt 60  
**Domal** Domal Break 52 Finestra / Domal Break 70 Finestra  
Domal Stopper Pg Finestra  
**Equipe** Sistema 8000 G.A. Finestra 1 Anta  
Sistema 8000 G.A. Finestra 2 Ante  
**Esa** Isola Porta  
**Esedra** Ga 53 Porta / Ga 53 Porta / Tt 63 Porta / Tt 63 Porta  
Tt 75 Porta / Tt 75 Porta  
**Indinvest** Gold 400 Complanare / Gold 400 Sormonto  
Gold 500 Complanare / Gold 500 Sormonto  
Gold 600 Complanare / Gold 600 Sormonto  
**Metra** Nc 45 International Finestra / Nc 45 Superthermic Finestra  
Nc 55 International Finestra / Nc 68 Superthermic Finestra  
**Morelli** Ma 8300  
**Ocma** Fc 47 Finestra / Fc 55 Finestra / Fc 60 Tt Finestra  
**Passerini** Ekip 40 Evoluzione 2 Ante / Ekip 40 Sormonto 2 Ante  
Ekip 50 Sormonto 2 Ante / Ekip Maastricht 53 Finestra  
Ekip Maastricht Th 60 Finestra / Ekip Maastricht Th 68 Finestra  
**Profilati** "Pe" "Eku 53" Finestra / "Pe" "Eku 64 Tt" Finestra  
"Pe" "Eku 72 Tt" Finestra"

Striking plates

**FOR CENTRAL LOCK PERFORMA.**

in stainless steel. Flat front plate **22x1,5x180.**

**038235** D 10 - 10

**For locks for metal frames series 72\***



Code

Min. ord.  
Multiple package  
Single package  
Status

**Perforza**



Full-size scale

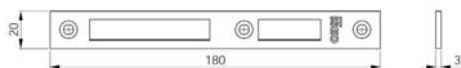

METRA PARETI MOBILI

Striking plates

**FOR CENTRAL LOCK** PERFORMA.

Stainless steel. Flat front plate **20x3x180**.

**038228** D 10 - 10



Full-size scale

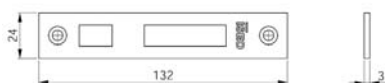

**ALCOA** Fd 12 Blindato  
Fb 12 Trad./Revamping  
Gr 9  
Plana 1 Anta  
**ESA** Blindal 60 Porta 1 Anta  
Blindal 60 Porta 2 Ante  
**ESA** Blindal 70 Porta 1 Anta  
Blindal 70 Porta 2 Ante  
**SCHUCO** Royal S 50 N  
Royal S 55 Tt  
Royal S 65 Tt

Striking plates

**FOR DEVIATORS** PERFORMA.

Stainless steel. Flat front plate **24x3x132**.

**038220** C 10 - 10

Nickel plated. Flat front plate **24x3x132**.

**038220H3** D 10 - 10



Full-size scale

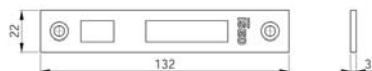

**Alcan** Abithal Cristal / Abithal Keeper Porta C.E.  
Winner Finestra  
**Alcoa** Fb 12 Ga / Europa Ga / Fb 12 T.T. / R 35 Reversibile  
R 35 Sormonto  
**ALL.Co** Export 40 Finestra / Export 50 Finestra  
Export 50 Tt Finestra / Final 40 Finestra / Scurbin C.E.  
**Alu-mec** Synthesis 45 Finestra / Synthesis 57 Finestra  
Synthesis 60 Tt Finestra  
**Alusuisse** Alsec 2000 Finestra 59 / Alsec 2000 Finestra 69  
**Badlega** Bga 50 / New Bt 60  
**Domal** Domal Break 52 Finestra / Domal Break 70 Finestra  
Domal Stopper Pg Finestra  
**Equip** Sistema 8000 G.A. Finestra 1 Anta  
Sistema 8000 G.A. Finestra 2 Ante  
**Esa** Isola Porta  
**Esadra** Ga 53 Porta / Ga 53 Porta / Tt 63 Porta / Tt 63 Porta  
Tt 75 Porta / Tt 75 Porta  
**Indinvest** Gold 400 Complanare / Gold 400 Sormonto  
Gold 500 Complanare / Gold 500 Sormonto  
Gold 600 Complanare / Gold 600 Sormonto  
**Metra** Nc 45 International Finestra / Nc 45 Superthermic Finestra  
Nc 55 International Finestra / Nc 68 Superthermic Finestra  
**Morelli** Ma 8300  
**Oma** Fc 47 Finestra / Fc 55 Finestra / Fc 60 Tt Finestra  
**Passerini** Ekip 40 Evoluzione 2 Ante / Ekip 40 Sormonto 2 Ante  
Ekip 50 Sormonto 2 Ante / Ekip Maastricht 53 Finestra  
Ekip Maastricht Th 60 Finestra / Ekip Maastricht Th 68 Finestra  
**Profilati** \*Pe \*\*Eku 53\*\* Finestra / \*Pe \*\*Eku 64 Tt\*\* Finestra  
\*Pe \*\*Eku 72 Tt\*\* Finestra

Striking plates

**FOR DEVIATORS** PERFORMA.

Stainless steel. Flat front plate **22x3x132**.

**038221** C 10 - 10

**For locks for metal frames series 72\***



Code

Min. ord.  
Multiple package  
Single package  
Status

**Perforza**



Full-size scale

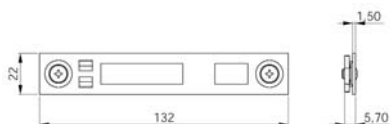

- Alcan Abithal Cristal / Abithal Keeper Porta C.E.
- Winner Finestra
- Alcoa Fb 12 Ga / Europa Ga / Fb 12 T.T. / R 35 Reversibile R 35 Sormonto
- All.Co Export 40 Finestra / Export 50 Finestra
- Export 50 Tt Finestra / Final 40 Finestra / Sicurblin C.E.
- Alu-mec Synthesis 45 Finestra / Synthesis 57 Finestra
- Synthesis 60 Tt Finestra
- Alusuisse Alsec 2000 Finestra 59 / Alsec 2000 Finestra 69
- Bodega Bga 50 / New Bt 60
- Domal Domal Break 52 Finestra / Domal Break 70 Finestra
- Domal Stopper Pg Finestra
- Equipe Sistema 8000 G.A. Finestra 1 Anta
- Sistema 8000 G.A. Finestra 2 Anta
- Esa Isola Porta
- Esedra Ga 53 Porta / Ga 53 Porta / Tt 63 Porta / Tt 63 Porta
- Tt 75 Porta / Tt 75 Porta
- Indinvest Gold 400 Complanare / Gold 400 Sormonto
- Gold 500 Complanare / Gold 500 Sormonto
- Gold 600 Complanare / Gold 600 Sormonto
- Metra Nc 45 International Finestra / Nc 45 Superthermic Finestra
- Nc 55 International Finestra / Nc 68 Superthermic Finestra
- Morelli Ma 8300
- Ocma Fc 47 Finestra / Fc 55 Finestra / Fc 60 Tt Finestra
- Passerini Ekip 40 Evoluzione 2 Ante / Ekip 40 Sormonto 2 Ante
- Ekip 50 Sormonto 2 Ante / Ekip Maastricht 53 Finestra
- Ekip Maastricht Th 60 Finestra / Ekip Maastricht Th 68 Finestra
- Profiliati \*Pe \*\*Eku 53\*\* Finestra / \*Pe \*\*Eku 64 Tt\*\* Finestra
- \*Pe \*\*Eku 72 Tt\*\* Finestra

Striking plates

**FOR DEVIATORS PERFORMA.**

Stainless steel. Flat front plate **22x1,5x132.**

**038225** D 10 - 10



Full-size scale



**METRA PARETI MOBILI**

Striking plates

**FOR DEVIATORS PERFORMA.**

Stainless steel. Flat front plate **20x3x132.**

**038227** D 10 - 10

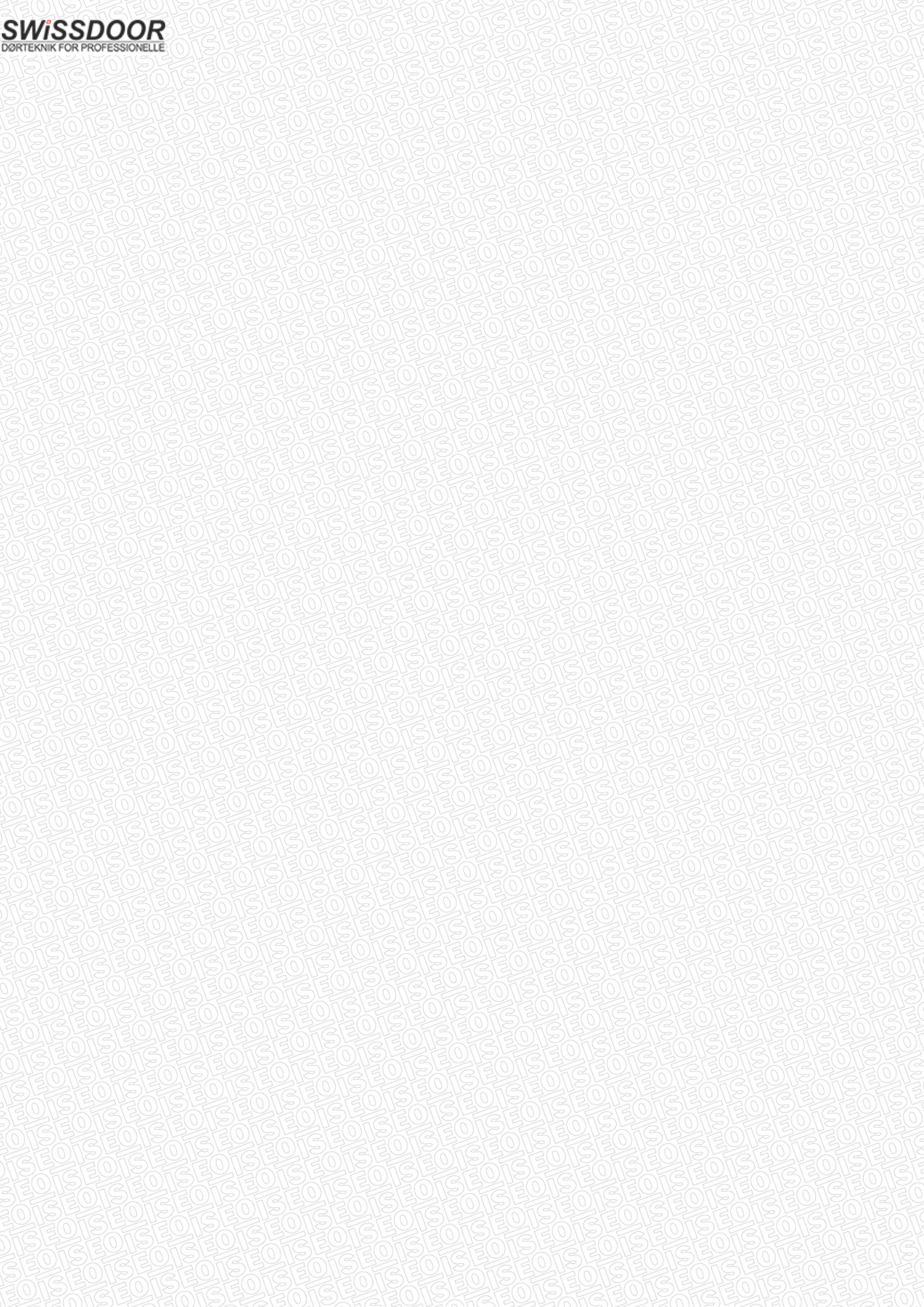

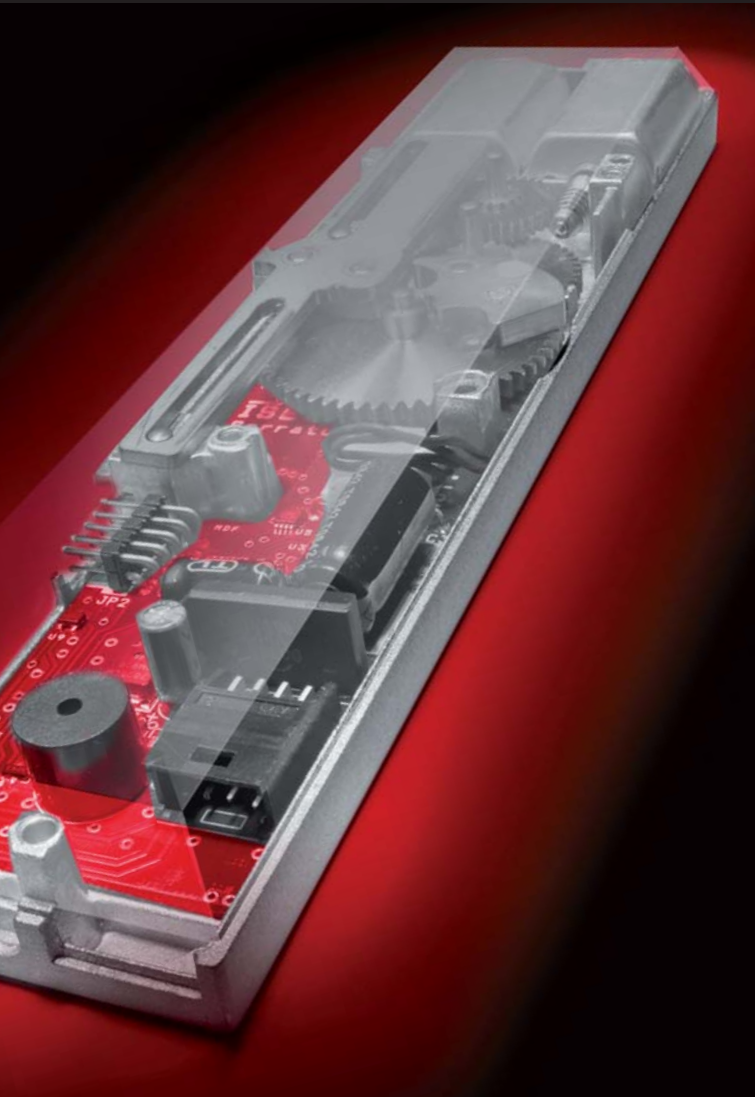

**Multiblindo  Motion**  
Electromechanical  
automatic lock



## Multiblindo eMotion

Perfect combination of comfort and security in any situation.

The new electromechanical automatic lock represents the electronic evolution of Multiblindo Easy.

From the outside it operates by key or the most advanced electronic access control systems: fingerscan, keyboard, transponder, PIN-code. From the inside it operates electronically in a simple and fast way through a normal keyboard, allowing the end user to set three different locking functions: Total, Light, Free.



### It is certified

according with EN14846:08 and prEN15685:09 European standards.

Multiblindo eMotion ensures top-level intrusion protection; it doesn't lose the settings in case of a black-out and, if necessary, it always assures the mechanical key or handle action.

Example of certification:



### With sound feedback

A special system monitors the door status and sends opening and closing sound signals, which can be set or completely excluded by the end user.



### Set your time

The user can set the time span between the opening pulse and the automatic relocking of the door.

Multiblindo eMotion has three options allowing an instant opening as well as to choose the automatic relocking mode according to the user's security requirements. It is operated through an electronic control for all the settings.

**Total.** When pressing the pushbutton the door opens and a sound signal is produced. When it closes, Multiblindo eMotion will automatically trigger the latchbolt and deadbolts: the sound feedback will indicate the total locking. Total security: this setting ensures your door the highest security.

**Light.** When pressing the pushbutton the door opens and a sound signal is produced. When it closes, Multiblindo eMotion will automatically trigger the latchbolt only: a different and more flexible security level for a partial and fast locking.

**Free.** With this setting, Multiblindo eMotion keeps the latchbolt and deadbolts completely unlocked: the door will stay in a free-opening status, in the classic hold-open situation. Total freedom ensuring a free access both from inside and outside until a new setting is given.

## Conventional definition of door handing.

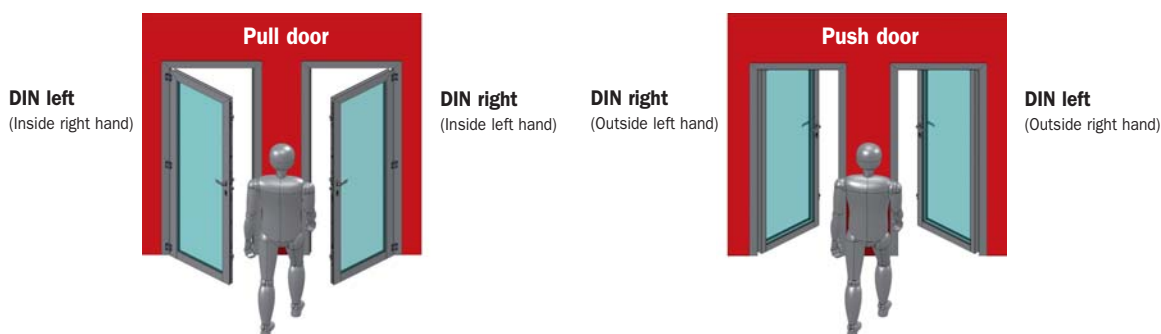



**Multiblindo Motion 92 mm centre distance**

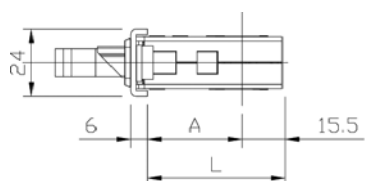
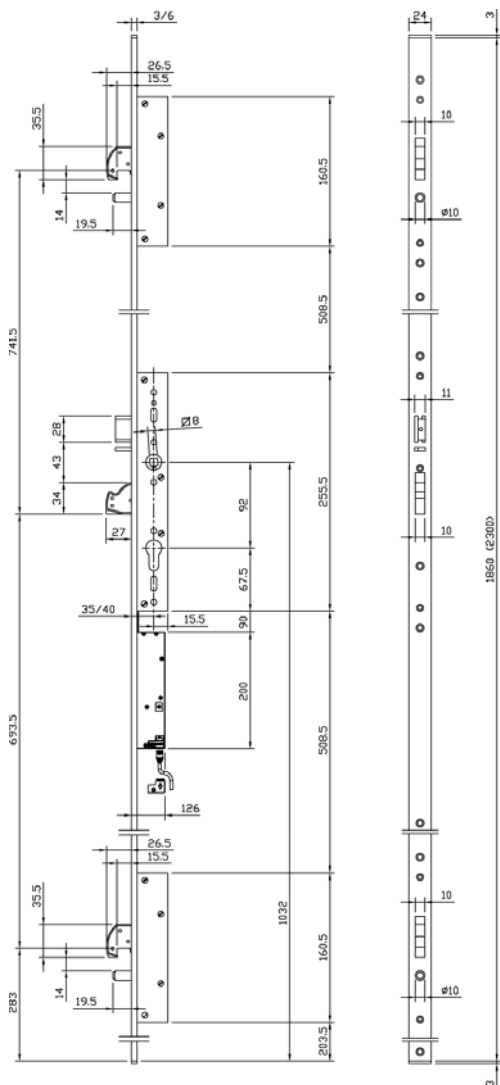
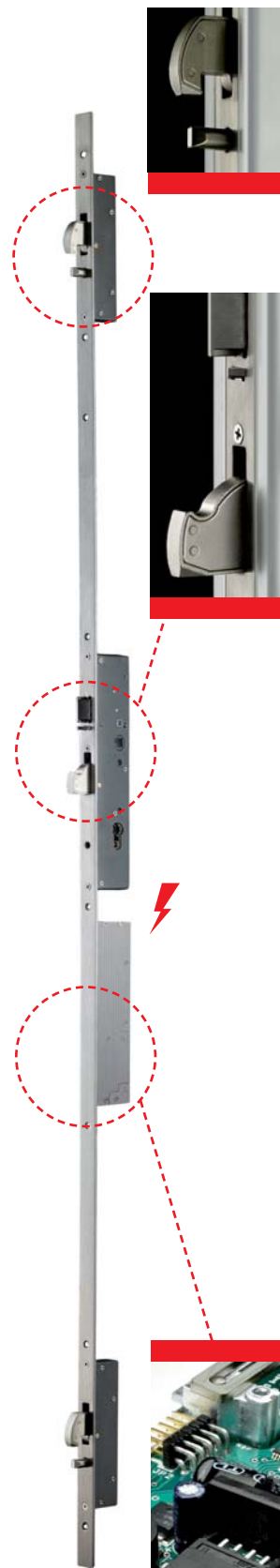

ENTRATA	A	L
35	28	43.5
40	33	58.5

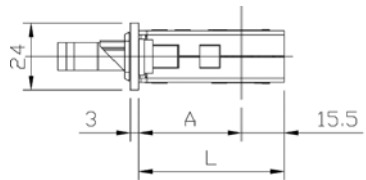

ENTRATA	A	L
35	32	47.5
40	37	52.5

**ELECTROMECHANICAL 12V D.C.** MULTIPOINT mortice lock for metal frames, AUTOMATIC LOCKING OF THE LATCHBOLT AND 3 DEADBOLTS, **ROTATING HOOK DEVIATORS**, Central lock, handle follower centre distance mm 92, operating with European profile cylinder. Right or left latchbolt, **non reversible**.

Deadbolts and latchbolt operated by key, handle or motor.

Lock and deviators deadbolts mm 27 throw, with anti-drill and anti-cut cover plates in carbonitrided steel.

Connection cable, 2 nylon end blocks for U-version. Fixing screws. Instruction sheet.

**Accessories to be ordered separately:**

Striking plates

**U-front plate**

mechanical strikers 033202 - 033203

strikers for deviators 033167 - 033171

**Flat front plate**

mechanical striker 033200 - 033201

strikers for deviators 033165 - 033169





Code

Min. ord.  
Multiple  
package  
Single  
package  
Status

**Multiblindo Motion 92 mm centre distance**

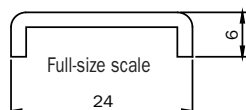

U-front plate mm <b>2300 x 24 x 6</b> in stainless steel. Backset mm 35 <b>DIN RIGHT</b>	<b>7A3600352.D</b>	D	1	-	1
U-front plate mm <b>2300 x 24 x 6</b> in stainless steel. Backset mm 40 <b>DIN RIGHT</b>	<b>7A3600402.D</b>	D	1	-	1
U-front plate mm <b>2300 x 24 x 6</b> in stainless steel. Backset mm 35 <b>DIN LEFT</b>	<b>7A3600352.S</b>	D	1	-	1
U-front plate mm <b>2300 x 24 x 6</b> in stainless steel. Backset mm 40 <b>DIN LEFT</b>	<b>7A3600402.S</b>	D	1	-	1

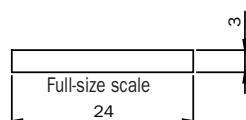

Flat front plate mm <b>2300 x 24 x 3</b> in stainless steel. Backset mm 35 <b>DIN RIGHT</b>	<b>7A3610352.D</b>	D	1	-	1
Flat front plate mm <b>2300 x 24 x 3</b> in stainless steel. Backset mm 40 <b>DIN RIGHT</b>	<b>7A3610402.D</b>	D	1	-	1
Flat front plate mm <b>2300 x 24 x 3</b> in stainless steel. Backset mm 35 <b>DIN LEFT</b>	<b>7A3610352.S</b>	D	1	-	1
Flat front plate mm <b>2300 x 24 x 3</b> in stainless steel. Backset mm 40 <b>DIN LEFT</b>	<b>7A3610402.S</b>	D	1	-	1



Power supply - <b>230V A.C. - 12V D.C. - 3A</b>	<b>94403000E</b>	D	1	-	1
---	------------------	---	---	---	---



External soft cable tube L=300	<b>94403010E</b>	D	1	-	1
--------------------------------	------------------	---	---	---	---



Built-in soft cable tube L=300	<b>94403110E</b>	D	1	-	1
--------------------------------	------------------	---	---	---	---



**Multiblindo Easy**  
Automatic lock



## Multiblindo Easy

It is a Multiblindo by all means: same sizes and dimensions, same security level. But it is an all-new Multiblindo, **conceived with 3 different functions to be set by the end user.**

To use Multiblindo Easy you need to apply an external fixed knob or a pull handle; as a matter of fact, a “classic handle” would unlock the door (emergency function).



### It has been designed and tested

according to the European standard prEN 15685.  
It resists lateral forcing with a thrust of over 1,000 kg and a front load of over 600 kg.  
The corrosion resistance is more than 240 hours in a saline environment.  
Endurance: tested to over 200,000 opening and closing cycles under a 120N load.

Example of certification: lock Multiblindo Easy, models 7A32 – 7A34 – 7A36 – 7A38



### Locking.

The outstanding feature of Multiblindo Easy is the automatic locking of the latchbolt and deadbolts, which comes into operation when the door is pulled close to the door jamb. The end user may change the operating mode by switching the selector placed on the lock faceplate. A special patented device allows the deadbolts to come out of the cases only when the latchbolt goes into the striking plate for at least 3 mm. The latchbolt aligns perfectly the wing to the door jamb; this operation ensures the best condition for the free movement of the deadbolts.



### Opening.

**Outside opening:** the deadbolts are unlocked with a single turn of the key in the opening direction; the latchbolt is unlocked with a further ¼ turn.

**Inside opening:** the deadbolts are unlocked with a single turn of the key in the opening direction; the latchbolt is unlocked with a further ¼ turn.  
Latchbolt and deadbolts are unlocked with 45° lever rotation.

### Lever block.

The lever operation inside is blocked with a single turn of the key in the closing direction. The operation is restored with single turn of key in the opposite direction. To avoid incorrect or accidental use, the lever block operation is only allowed when the deadbolts are completely locked. This also ensures that:

- deadbolts automatic locking is fully completed
- deadbolts connecting rod has been blocked (an attack on one of the deadbolts does not damage the others). As far as security is concerned, the lever block prevents the opening from inside if required, or from outside in the event of a door breaking (i.e. glass frame doors).  
In terms of safety it ensures a better exit control.



**Total “0”** Deadbolts and latchbolt automatic locking



**Light “1”** Locking by latchbolt only



**Free “2”** Setting without locking (it allows to set the hold-open function)

## Multiblindo Easy

The door fitted with a Multiblindo Easy lock and tested by the **German Institute IFT ROSENHEIM** passed **CLASS 2 test according to EUROPEAN STANDARD DIN V ENV 1627:1999**



**Nachweis**  
einbruchhemmende Eigenschaften

Prüfbericht 212 38908

Auftraggeber: **Hörmann KG Eckelhausen**  
In der Bruchwiese 2  
66625 Nohfelden

---

Produkt: einbruchhemmende Tür mit festem Seitenteil

Bezeichnung: **TopPrestige**

---

Außenmaß (B x H): **2300 mm x 2300 mm**

(Rahmen)  
Material, System: **Aluminium / Hörmann H20000, H21000, H25000**

Angriffsseite: **Schließseite/Schließfläche nach DIN 107**

Öffnungsart: **Drehflügel nach innen**  
Klasse P4 A Nach EN 356

Verglastung: **Alupaneel ohne Nachweis**  
Automatikschloss, Dreifachverriegelung mit Bolzen-, Hakenkombinator, Typ Iseo-Multiblindo Hörmann-H5, Fa. Iseo Serrature; Profilylinder Typ R6 Fa. Iseo; Schutzbeschlag Hörmann-HS1; zwei zweiteilige Bänder Nr. 4, Fa. Dr. Walter Hahn

Beschläge: **Gemäß der Montageanleitung der Firma Hörmann KG Eckelhausen**

Montage: **Hörmann KG Eckelhausen**

Schließzustand: **geschlossen, verriegelt und verschlossen**

**Einbruchhemmung**

**Widerstandsklasse 2**

**Grundlagen**  
DIN V ENV 1627 : 1999  
Fenster, Türen, Abschlässe -  
Einbruchhemmung – Anforderungen  
und Klassifizierung  
DIN V ENV 1628 : 1999  
DIN V ENV 1629 : 1999  
DIN V ENV 1630 : 1999

**Darstellung**

**Verwendungshinweise**  
Dieser Prüfbericht dient zum  
Nachweis der einbruchhem-  
menden Eigenschaften.

**Gültigkeit**  
Die genannten Daten und Er-  
gebnisse beziehen sich aus-  
schließlich auf den geprüften  
und beschriebenen Probekör-  
per. Die Prüfung der Einbruch-  
hemmung ermöglicht keine  
Aussage über weitere lei-  
stungs- und qualitätsbestim-  
mende Eigenschaften der vor-  
liegenden Konstruktion.

Abweichend von geprüften Aus-  
führung sind folgende Größen-  
änderungen zulässig:  
in der Breite +10% und -20%  
in der Höhe +10% und -20%

**Veröffentlichungshinweise**  
Es gilt das Ift-Merkblatt „Bedin-  
gungen und Hinweise zur Be-  
nutzung von Ift-Prüf-  
dokumentationen“.  
Das Deckblatt kann als Kurz-  
fassung verwendet werden.

**Inhalt**  
Der Nachweis umfasst insge-  
samt 43 Seiten  
1 Gegenstand  
2 Durchführung  
3 Einzelergebnisse  
4 Beurteilung  
Anlage 1 (15 Seiten)  
Anlage 2 (11 Seiten)

ift Rosenheim  
17. Dezember 2009

**Christian Kehrer**  
Christian Kehrer, Dipl.-Ing. (FH)  
Prüfstellenleiter  
ift Zentrum Türen, Tore, Sicherheit

**Gerhard Fellermeier**  
Gerhard Fellermeier, Dipl.-Ing. (FH)  
Prüfingenieur  
ift Zentrum Türen, Tore, Sicherheit

PFE Rosenheim GmbH  
ift Zentrum – Türen, Tore, Sicherheit  
Geschäftsführer  
Dr. Jochen Pechel

Theodor-Gieseler-Str. 7 - 9  
D-33228 Rosenheim  
Tel.: +49 (0)8231/20-0  
Fax: +49 (0)8231/20-240  
www.pfe-rosenheim.de

Str. 63026 Rosenheim  
A3 Taubstein 198 14022  
Soarkasse Rosenheim  
RtD 500 420 626  
B.Z. 711 500 02

Notified Body for "DTS"  
Anerkannter Prüfzweig: BA/10

CLASS  
2



## Multiblindo Easy 92 mm centre distance

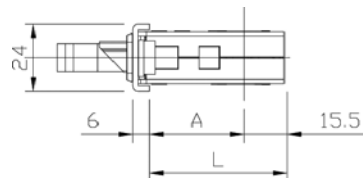
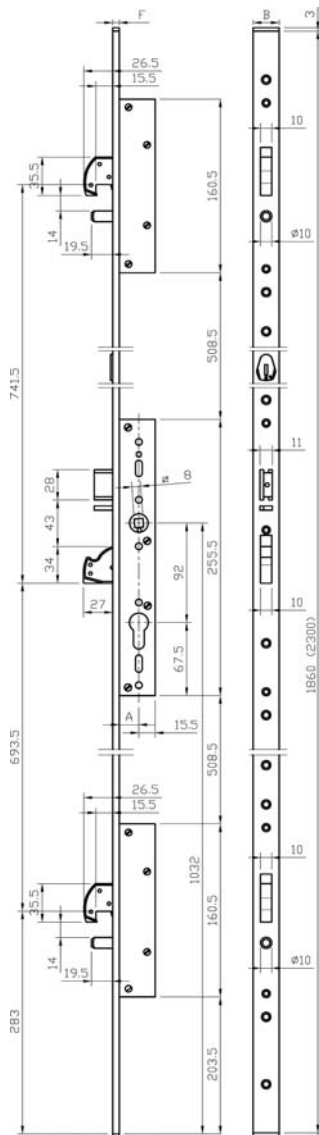

ENTRATA	A	L
35	28	43.5
40	33	58.5

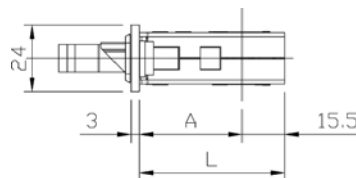

ENTRATA	A	L
35	32	47.5
40	37	52.5

MULTIPOINT mortice lock for metal frames,  
AUTOMATIC LOCKING OF THE LATCHBOLT AND 3 DEADBOLTS, **ROTATING HOOK DEVIATORS**.  
Central lock, centre distance mm 92, operating with European profile cylinder.  
Right or left latchbolt, **non reversible**. Deadbolts and latchbolt operated by key or handle.  
Lock and deviators deadbolts, mm 27 throw, with anti-drill and anti-cut cover plates in carbonitrided steel.  
2 nylon end blocks for U-version. Fixing screws. Instruction sheet.

**Accessories to be ordered separately:**

Striking plates

**Front plate in stainless steel 24x6x1860:**

mechanical strikers 033202 - 033203

electric strikers 033212 - 033213

strikers for deviators 033167 - 033171

**Flat front plate in stainless steel 24x3x2300:**

mechanical strikers 033200 - 033201

electric strikers 033210 - 033211

strikers for deviators 033165 - 033169



Code

Status  
Single  
package  
Multiple  
package  
Min. ord.

**Multiblindo Easy 92 mm centre distance**

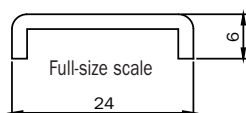

U-front plate mm <b>1860 x 24 x 6</b> in stainless steel. Backset mm 35 <b>DIN RIGHT</b>	<b>7A3201352.D</b>	C	1	-	1
U-front plate mm <b>1860 x 24 x 6</b> in stainless steel. Backset mm 40 <b>DIN RIGHT</b>	<b>7A3201402.D</b>	B	1	-	1
U-front plate mm <b>1860 x 24 x 6</b> in stainless steel. Backset mm 35 <b>DIN LEFT</b>	<b>7A3201352.S</b>	C	1	-	1
U-front plate mm <b>1860 x 24 x 6</b> in stainless steel. Backset mm 40 <b>DIN LEFT</b>	<b>7A3201402.S</b>	B	1	-	1

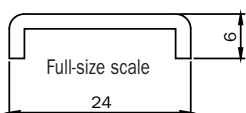

U-front plate mm <b>2300 x 24 x 6</b> in stainless steel. Backset mm 35 <b>DIN RIGHT</b>	<b>7A3200352.D</b>	D	1	-	1
U-front plate mm <b>2300 x 24 x 6</b> in stainless steel. Backset mm 40 <b>DIN RIGHT</b>	<b>7A3200402.D</b>	D	1	-	1
U-front plate mm <b>2300 x 24 x 6</b> in stainless steel. Backset mm 35 <b>DIN LEFT</b>	<b>7A3200352.S</b>	D	1	-	1
U-front plate mm <b>2300 x 24 x 6</b> in stainless steel. Backset mm 40 <b>DIN LEFT</b>	<b>7A3200402.S</b>	D	1	-	1

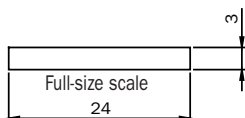

Flat front plate mm <b>2300 x 24 x 3</b> in stainless steel. Backset mm 35 <b>DIN RIGHT</b>	<b>7A3210352.D</b>	C	1	-	1
Flat front plate mm <b>2300 x 24 x 3</b> in stainless steel. Backset mm 40 <b>DIN RIGHT</b>	<b>7A3210402.D</b>	C	1	-	1
Flat front plate mm <b>2300 x 24 x 3</b> in stainless steel. Backset mm 35 <b>DIN LEFT</b>	<b>7A3210352.S</b>	D	1	-	1
Flat front plate mm <b>2300 x 24 x 3</b> in stainless steel. Backset mm 40 <b>DIN LEFT</b>	<b>7A3210402.S</b>	D	1	-	1

**Conventional definition of door handing.**

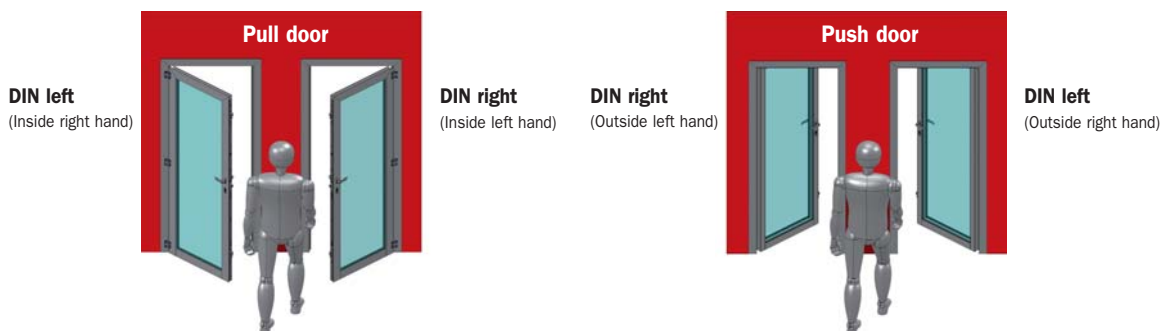



Code

Min. ord.  
Multiple  
package  
Single  
package  
Status

**Option: with hole for SWISS profile cylinder**



For cylinder 22 mm



**Multiblindo Motion**

**ELECTROMECHANICAL central lock, centre distance 94 mm**

U-front plate mm <b>1860 x 24 x 6</b> in stainless steel. Backset 40 mm	<b>DIN RIGHT * 7A3801402.D</b>	D	1	-	1
U-front plate mm <b>1860 x 24 x 6</b> in stainless steel. Backset 40 mm	<b>DIN LEFT * 7A3801402.S</b>	D	1	-	1
U-front plate mm <b>2300 x 24 x 6</b> in stainless steel. Backset 40 mm	<b>DIN RIGHT * 7A3800402.D</b>	D	1	-	1
U-front plate mm <b>2300 x 24 x 6</b> in stainless steel. Backset 40 mm	<b>DIN LEFT * 7A3800402.S</b>	D	1	-	1
U-front plate mm <b>2300 x 24 x 3</b> in stainless steel. Backset 40 mm	<b>DIN RIGHT * 7A3810402.D</b>	D	1	-	1
U-front plate mm <b>2300 x 24 x 3</b> in stainless steel. Backset 40 mm	<b>DIN LEFT * 7A3810402.S</b>	D	1	-	1

**Multiblindo Easy**

**MECHANICAL central lock, centre distance 94 mm**

U-front plate mm <b>1860 x 24 x 6</b> in stainless steel. Backset 40 mm	<b>DIN RIGHT * 7A3401402.D</b>	D	1	-	1
U-front plate mm <b>1860 x 24 x 6</b> in stainless steel. Backset 40 mm	<b>DIN LEFT * 7A3401402.S</b>	D	1	-	1
U-front plate mm <b>2300 x 24 x 6</b> in stainless steel. Backset 40 mm	<b>DIN RIGHT * 7A3400402.D</b>	D	1	-	1
U-front plate mm <b>2300 x 24 x 6</b> in stainless steel. Backset 40 mm	<b>DIN LEFT * 7A3400402.S</b>	D	1	-	1
U-front plate mm <b>2300 x 24 x 3</b> in stainless steel. Backset 40 mm	<b>DIN RIGHT * 7A3410402.D</b>	D	1	-	1
U-front plate mm <b>2300 x 24 x 3</b> in stainless steel. Backset 40 mm	<b>DIN LEFT * 7A3410402.S</b>	D	1	-	1

\* Availability and delivery to be agreed

**For locks for metal frames  
series 7A\***



Code

Min. ord.  
Multiple  
package  
Single  
package  
Status

**Multiblindo Easy and Multiblindo Motion**

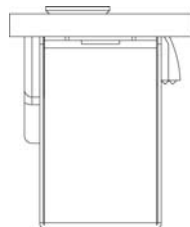

Full-size scale

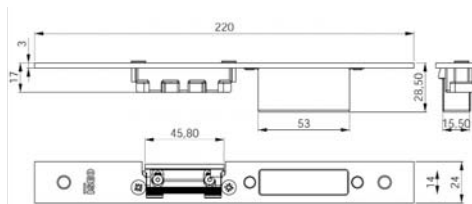

- ALL.CO All.Co 5 Porta / All.Co 5 TT Porta
- Export 50/50 TT Porta / Scirubin 65
- ALU-K Alublindo / N 45 Porta / N 53 Porta / N 55 TT Porta
- N 62 TT Porta
- ALU-MEC Synthesis 57 Porta / Synthesis 60TT Porta
- DOMAL Stopper PG Porta
- ESA Blindal 60 Porta 1 Anta / 60 Porta 2 Ante
- INDINVEST Alpha 445 Porta 2 Ante
- METRA NC 45 International Porta
- NC 45 Superthermic Porta / NC 55 International Porta
- NC 68 Superthermic Porta / Nuovo NC 50 Porta
- Superblindo
- PASSERINI Ekip Blindo
- SCHUCO Royal 78 ST Blindato
- Royal S 50 N
- Royal S 55 TT
- Royal S 65 TT

**ADJUSTABLE** closed striking plate for **CENTRAL LOCK**

MULTIBLINDO EASY and MULTIBLINDO EMOTION. Material: stainless steel.

With mechanical striker.

Flat front plate **24x3x220 DIN LEFT**

**033200** C 10 - 10

Flat front plate **24x3x220 DIN RIGHT**

**033201** D 10 - 10

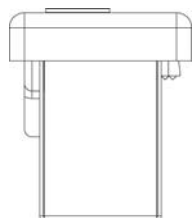

Full-size scale

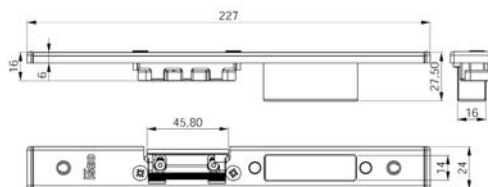

- ALCAN Abithal Keeper Porta 53-60 / 61-68
- Abithal Porta / Winner Porta
- ALCOA FB 12 Blindato Porta
- Plana 1 Anta / Plana 2 Ante
- ALL.CO All.Co 5 Porta / All.Co 5 TT Porta
- Export 50/50 TT Porta / Scirubin 65
- ALNOR Montreal Porta
- ALUSUISSE Alsec 2000 Porta 59 / Alsec 2000 Porta 69
- ALU-K Alublindo / N 45 Porta / N 53 Porta / N 55 TT Porta
- N 62 TT Porta
- ALU-MEC Synthesis 57 Porta / Synthesis 60TT Porta
- BODEGA Extrablind 70
- DOMAL Domal Break 52 Porta / Domal Break 70 Porta
- Security Porta / Shops Porta / Stopper PG Porta
- ESA Blindal 60 Porta 1 Anta / 60 Porta 2 Ante
- Blindal 70 Porta 1 Anta / 70 Porta 2 Ante
- FRESIA Global 48 Porta
- INDINVEST Alpha 445 Porta 2 Ante
- METRA NC 45 International Porta
- NC 45 Superthermic Porta / NC 55 International Porta
- NC 68 Superthermic Porta / Nuovo NC 50 Porta
- Superblindo
- NEW TEC New Tec 50 Porta Complanare
- OCMA SV 47 Porta 1 Anta
- SV 62 Porta 1 Anta
- SV 62 TT Porta 1 Anta
- PASSERINI Ekip Blindo
- Ekip Maastricht 53 Porta 1 Anta
- Ekip Maastricht 53 Porta 2 Ante
- Ekip Maastricht TH 60/68 Porta 1 Anta
- Ekip Maastricht TH 60/68 Porta 2 Ante
- Ekip Thermo 53 Porta
- PROFILATI PE " Eku 53" Porta
- PE "Eku 64 TT " Porta
- PE "Eku 72 Tt " Porta
- Sistema 1 PE 40 Complanare /Esterno 2 Ante
- Sistema 1 PE 40 Sormonto 2 Ante
- SCHUCO Royal 78 ST Blindato
- Royal S 50 N
- Royal S 55 TT
- Royal S 65 TT
- WICONA L60A / L70A

**ADJUSTABLE** closed striking plate for **CENTRAL LOCK**

MULTIBLINDO EASY and MULTIBLINDO EMOTION. Material: stainless steel.

With mechanical striker.

U-front plate **24x6x220 DIN LEFT**

**033202** D 10 - 10

U-front plate **24x6x220 DIN RIGHT**

**033203** D 10 - 10



**For locks for metal frames  
series 7A\***



Code

Min. ord.  
Multiple  
package  
Single  
package  
Status

**Multiblindo Easy**

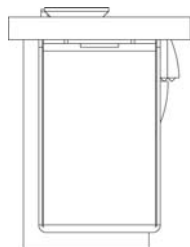

Full-size scale

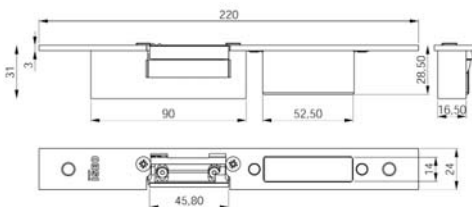

- ALL.CO All.Co 5 Porta / All.Co 5 TT Porta
- Export 50/50 TT Porta / Sicurblin 65
- ALU-K Alublindo / N 45 Porta / N 53 Porta / N 55 TT Porta
- N 62 TT Porta
- ALU-MEC Synthesis 57 Porta / Synthesis 60TT Porta
- DOMAL Stopper PG Porta
- ESA Blindal 60 Porta 1 Anta / 60 Porta 2 Ante
- INDINVEST Alpha 445 Porta 2 Ante
- METRA NC 45 International Porta
- NC 45 Superthermic Porta / NC 55 International Porta
- NC 68 Superthermic Porta / Nuovo NC 50 Porta
- Superblindo
- PASSERINI Ekip Blindo
- SCHUCO Royal 78 ST Blindato
- Royal S 50 N
- Royal S 55 TT
- Royal S 65 TT

**ADJUSTABLE** closed striking plate for **CENTRAL LOCK**

MULTIBLINDO EASY. Material: stainless steel.

With electric striker.

Flat front plate **24x3x220 DIN LEFT**

**033210** D 10 - 10

Flat front plate **24x3x220 DIN RIGHT**

**033211** D 10 - 10

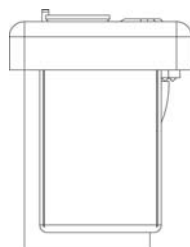

Full-size scale

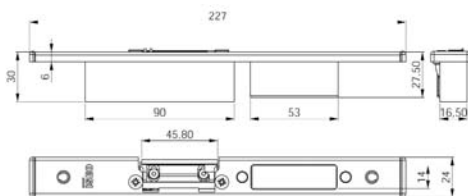

- ALCAN Abithal Keeper Porta 53-60 / 61-68
- Abithal Porta / Winner Porta
- ALCOA FB 12 Blindato Porta
- Plana 1 Anta / Plana 2 Ante
- ALL.CO All.Co 5 Porta / All.Co 5 TT Porta
- Export 50/50 TT Porta / Sicurblin 65
- ALNOR Montreal Porta
- ALUSISSE Alsec 2000 Porta 59 / Alsec 2000 Porta 69
- ALU-K Alublindo / N 45 Porta / N 53 Porta / N 55 TT Porta
- N 62 TT Porta
- ALU-MEC Synthesis 57 Porta / Synthesis 60TT Porta
- BODEGA Extrablind 70
- DOMAL Domal Break 52 Porta / Domal Break 70 Porta
- Security Porta / Shops Porta / Stopper PG Porta
- ESA Blindal 60 Porta 1 Anta / 60 Porta 2 Ante
- Blindal 70 Porta 1 Anta / 70 Porta 2 Ante
- FRESIA Global 48 Porta
- INDINVEST Alpha 445 Porta 2 Ante
- METRA NC 45 International Porta
- NC 45 Superthermic Porta / NC 55 International Porta
- NC 68 Superthermic Porta / Nuovo NC 50 Porta
- Superblindo
- NEW TEC New Tec 50 Porta Complanare
- OCMA SV 47 Porta 1 Anta
- SV 62 Porta 1 Anta
- SV 62 TT Porta 1 Anta
- PASSERINI Ekip Blindo
- Ekip Maastricht 53 Porta 1 Anta
- Ekip Maastricht 53 Porta 2 Ante
- Ekip Maastricht TH 60/68 Porta 1 Anta
- Ekip Maastricht TH 60/68 Porta 2 Ante
- Ekip Thermo 53 Porta
- PROFILATI PE " Eku 53" Porta
- PE "Eku 64 TT " Porta
- PE "Eku 72 Tt " Porta
- Sistema 1 PE 40 Complanare /Esterno 2 Ante
- Sistema 1 PE 40 Sormonto 2 Ante
- SCHUCO Royal 78 ST Blindato
- Royal S 50 N
- Royal S 55 TT
- Royal S 65 TT
- WICONA L60A / L70A

**ADJUSTABLE** closed striking plate for **CENTRAL LOCK**

MULTIBLINDO EASY. Material: stainless steel.

With electric striker.

U-front plate **24x6x220 DIN LEFT**

**033212** D 10 - 10

U-front plate **24x6x220 DIN RIGHT**

**033213** D 10 - 10

**For locks for metal frames series 7A\***



Code

Min. ord.  
Multiple package  
Single package  
Status

**Multiblindo Easy**

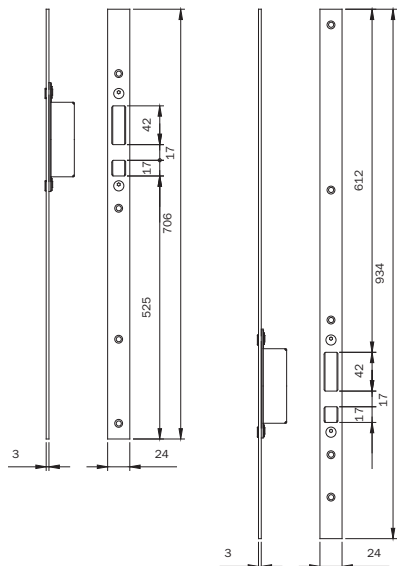
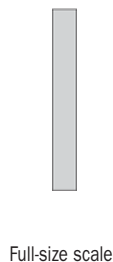

- ALL.CO All.Co 5 Porta / All.Co 5 TT Porta
- Export 50/50 TT Porta / Sicurblin 65
- ALU-K Alublindo / N 45 Porta / N 53 Porta / N 55 TT Porta
- N 62 TT Porta
- ALU-MEC Synthesis 57 Porta / Synthesis 60TT Porta
- DOMAL Stopper PG Porta
- ESA Blindal 60 Porta 1 Anta / 60 Porta 2 Ante
- INDINVEST Alpha 445 Porta 2 Ante
- METRA NC 45 International Porta
- NC 45 Superthermic Porta / NC 55 International Porta
- NC 68 Superthermic Porta / Nuovo NC 50 Porta
- Superblindo
- PASSERINI Ekip Blindo
- SCHUCO Royal 78 ST Blindato
- Royal S 50 N
- Royal S 55 TT
- Royal S 65 TT

Pair of **ADJUSTABLE** closed **STRIKING PLATES** for top/bottom **HOOK DEVIATORS** MULTIBLINDO EASY.

Material: stainless steel. Flat front plate **24X3X1860**

Can be used with central striking plates.

033200 - 033201 - 033210 - 033211 - 033160 - 033161

**033165** D 10 - 10

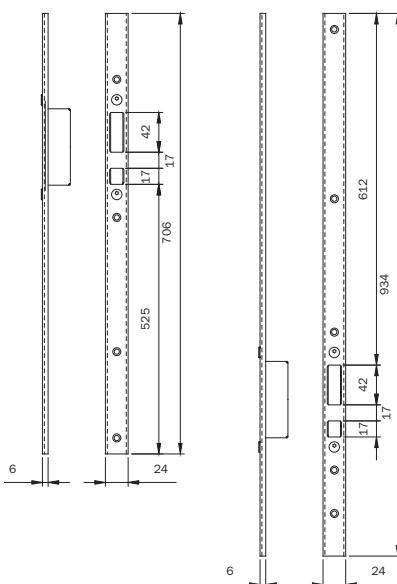
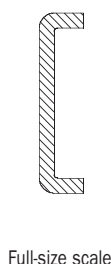

- ALCAN Abithal Keeper Porta 53-60 / 61-68
- Abithal Porta / Winner Porta
- ALCOA FB 12 Blindato Porta
- Plana 1 Anta / Plana 2 Ante
- ALL.CO All.Co 5 Porta / All.Co 5 TT Porta
- Export 50/50 TT Porta / Sicurblin 65
- ALNOR Montreal Porta
- ALUSUISSE Alsec 2000 Porta 59 / Alsec 2000 Porta 69
- ALU-K Alublindo / N 45 Porta / N 53 Porta / N 55 TT Porta
- N 62 TT Porta
- ALU-MEC Synthesis 57 Porta / Synthesis 60TT Porta
- BODEGA Extrablind 70
- DOMAL Domal Break 52 Porta / Domal Break 70 Porta
- Security Porta / Shops Porta / Stopper PG Porta
- ESA Blindal 60 Porta 1 Anta / 60 Porta 2 Ante
- Blindal 70 Porta 1 Anta / 70 Porta 2 Ante
- FRESIA Global 48 Porta
- INDINVEST Alpha 445 Porta 2 Ante
- METRA NC 45 International Porta
- NC 45 Superthermic Porta / NC 55 International Porta
- NC 68 Superthermic Porta / Nuovo NC 50 Porta
- Superblindo
- NEW TEC New Tec 50 Porta Complanare
- OCMA SV 47 Porta 1 Anta
- SV 62 Porta 1 Anta
- SV 62 TT Porta 1 Anta
- PASSERINI Ekip Blindo
- Ekip Maastricht 53 Porta 1 Anta
- Ekip Maastricht 53 Porta 2 Ante
- Ekip Maastricht TH 60/68 Porta 1 Anta
- Ekip Maastricht TH 60/68 Porta 2 Ante
- Ekip Thermo 53 Porta
- PROFILATI PE "Eku 53" Porta
- PE "Eku 64 TT " Porta
- PE "Eku 72 Tt " Porta
- Sistema 1 PE 40 Complanare /Esterno 2 Ante
- Sistema 1 PE 40 Sormonto 2 Ante
- SCHUCO Royal 78 ST Blindato
- Royal S 50 N
- Royal S 55 TT
- Royal S 65 TT
- WICONA L60A / L70-A

Pair of **ADJUSTABLE** closed **STRIKING PLATES** for top/bottom **HOOK DEVIATORS** MULTIBLINDO. Material: stainless steel.

U-front plate **24X6X1860**. Can be used with central striking plates

033202 - 033203 - 033212 - 033213 - 033162 - 033163

**033167** C 10 - 10

**For locks for metal frames  
series 7A\***



Code

Min. ord.  
Multiple  
package  
Single  
package  
Status

**Multiblindo Easy and Multiblindo eMotion**



Full-size scale

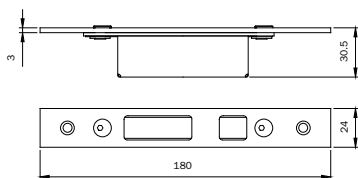

**ALL.CO** All.Co 5 Porta / All.Co 5 TT Porta  
Export 50/50 TT Porta / Sicurblin 65  
**ALU-K** Alublindo / N 45 Porta / N 53 Porta / N 55 TT Porta  
N 62 TT Porta  
**ALU-MEC** Synthesis 57 Porta / Synthesis 60TT Porta  
**DOMAL** Stopper PG Porta  
**ESA** Blindal 60 Porta 1 Anta / 60 Porta 2 Ante  
**INDINVEST** Alpha 445 Porta 2 Ante  
**METRA** NC 45 International Porta  
NC 45 Superthermic Porta / NC 55 International Porta  
NC 68 Superthermic Porta / Nuovo NC 50 Porta  
Superblindo  
**PASSERINI** Ekip Blindo  
**SCHUCO** Royal 78 ST Blindato  
Royal S 50 N  
Royal S 55 TT  
Royal S 65 TT

**ADJUSTABLE** closed striking plate for **HOOK DEVIATORS** MULTIBLINDO EASY and MULTINBLINDO EMOTION.

Material: stainless steel. Flat front plate **24X3X180**. To be used with striking plates.

033200 - 033201 - 033210 - 033211 - 033160 - 033161

**033169** C 10 - 10

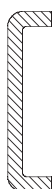

Full-size scale

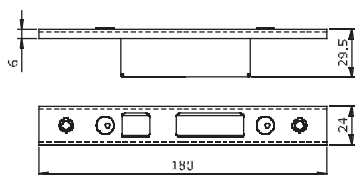

**ALCAN** Abithal Keeper Porta 53/60 / 61/68  
Abithal Porta / Winner Porta  
**ALCOA** FB 12 Blindato Porta  
Plana 1 Anta / Plana 2 Ante  
**ALL.CO** All.Co 5 Porta / All.Co 5 TT Porta  
Export 50/50 TT Porta / Sicurblin 65  
**ALNOR** Montreal Porta  
**ALUSUISSE** Alsec 2000 Porta 59 / Alsec 2000 Porta 69  
**ALU-K** Alublindo / N 45 Porta / N 53 Porta / N 55 TT Porta  
N 62 TT Porta  
**ALU-MEC** Synthesis 57 Porta / Synthesis 60TT Porta  
**BODEGA** Extrablind 70  
**DOMAL** Domal Break 52 Porta / Domal Break 70 Porta  
Security Porta / Shops Porta / Stopper PG Porta  
**ESA** Blindal 60 Porta 1 Anta / 60 Porta 2 Ante  
Blindal 70 Porta 1 Anta / 70 Porta 2 Ante  
**FRESIA** Global 48 Porta  
**INDINVEST** Alpha 445 Porta 2 Ante  
**METRA** NC 45 International Porta  
NC 45 Superthermic Porta / NC 55 International Porta  
NC 68 Superthermic Porta / Nuovo NC 50 Porta  
Superblindo  
**NEW TEC** New Tec 50 Porta Complanare  
**OCMA** SV 47 Porta 1 Anta  
SV 62 Porta 1 Anta  
SV 62 TT Porta 1 Anta  
**PASSERINI** Ekip Blindo  
Ekip Maastricht 53 Porta 1 Anta  
Ekip Maastricht 53 Porta 2 Ante  
Ekip Maastricht TH 60/68 Porta 1 Anta  
Ekip Maastricht TH 60/68 Porta 2 Ante  
Ekip Thermo 53 Porta  
**PROFILATI** PE " Eku 53" Porta  
PE "Eku 64 TT " Porta  
PE "Eku 72 Tt " Porta  
Sistema 1 PE 40 Complanare /Esterno 2 Ante  
Sistema 1 PE 40 Sormonto 2 Ante  
**SCHUCO** Royal 78 ST Blindato  
Royal S 50 N  
Royal S 55 TT  
Royal S 65 TT  
**WICONA** L60A / L70A

**ADJUSTABLE** closed striking plate for **HOOK DEVIATORS**

MULTIBLINDO EASY and MULTIBLINDO EMOTION.

Material: stainless steel.

U-front plate **24X3X180**. To be used with striking plates.

033202 - 033203 - 033212 - 033213 - 033162 - 033163

**033171** B 10 - 10



## **Multiblindo classic**

**Lock for  
metal frames**



## Multiblindo classic



### It has been designed and tested

according to the European standards EN 12209:05 (lateral locking version) and prEN 15685 (3-point locking version).

It resists lateral forcing with a thrust of over 1,000 kg and a front load of over 600 kg.

The corrosion resistance is more than 240 hours in a saline environment.

Endurance: tested to over 200,000 opening and closing cycles under a 120N load.

Example of certification lock Multiblindo, series 7955 - 7945 - 7991 - 79034



Adopting MULTIBLINDO, together with ISEO cylinders range, means reaching an extremely high security standard to the doors. MULTIBLINDO's security features include:

- steel lock case, closed on all sides;
- reinforced deadbolts with carbon-nitrite steel layers for high cut and drill protection;
- new deadbolt system (patented) preventing cracking (fig. 2,3,4);
- external forces applied on one of the deadbolts have no effect on the other two, which means that any eventual cracking attempts would have to be repeated separately for each deadbolt.

- A) DEADBOLT fulcrum pin
- B) Programmed breaking point
- C) Security pins
- D) Movement transmission and DEADBOLT locking rod

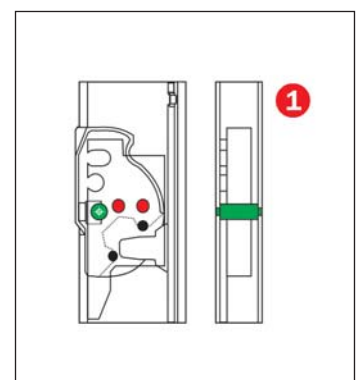
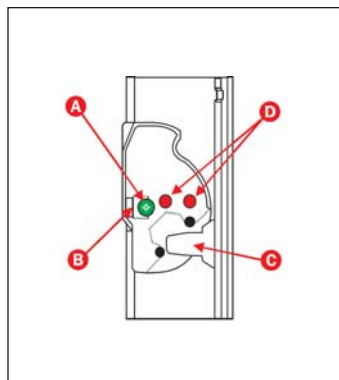

Open lock

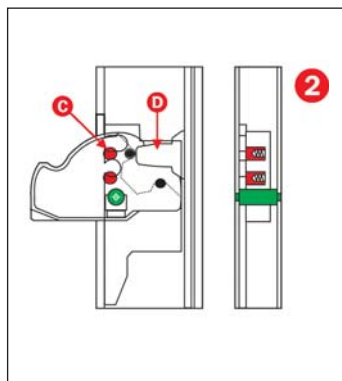

Closed lock. Blocking is ensured by element "D", which opposes the deadbolt and secures it against the back wall of the lock case. Pins "C" are not operating.

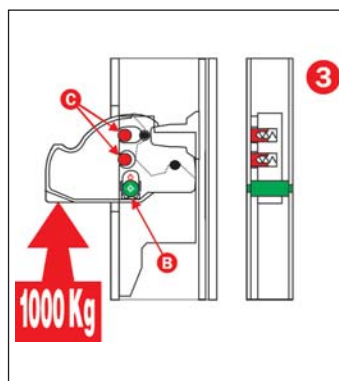

By applying an upwards force, equivalent to one metric ton, breaking point "B" yields letting pins "C" insert themselves into their respective spaces in the plate consolidated to the lock case. The dead bolt and the case fundamentally become one single body

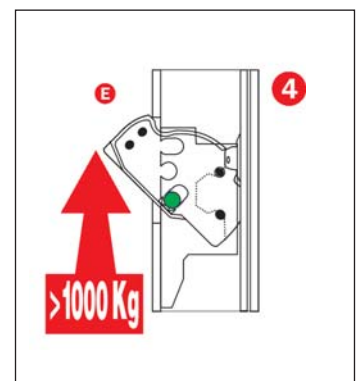

The deadbolt can no longer enter again the lock case when its rotation axis is moved, as it interferes with the front plate "E".

## Multiblindo classic

The door fitted with a Multiblindo lock and tested by the **German Institute IFT ROSENHEIM**, passed **CLASS 3 test according to EUROPEAN STANDARD DIN V ENV 1627:1999**



<b>Kurzbericht</b>		
Nr. 212 24151		
<b>Auftrag</b>	Prüfung der einbruchhemmenden Eigenschaften nach DIN V ENV 1627	
<b>Auftraggeber</b>	<b>Tegtmeier GmbH &amp; Co. KG Metallbauwerk</b> Oeynhausener Str. 40 32584 Löhne/Westfalen	
<b>Probekörper</b>	Prüfdatum 26. Juli 2001 Produktbezeichnung „Tebau Therm 80“ Bauart einflügelige Aluminiumrahmentür mit Seitenteil Angriffsseite Schließseite / Schließfläche gemäß DIN 107 Außenabmessungen 1400 mm x 2100 mm (B x H) Rahmenmaterial Aluminium Profilsystem TT80 Konstruktionsfugen Schattenfuge 4mm, unten 20 mm Beschläge *) Schloss Fa. ISEO Multi Blindo nach DIN 12209 Klasse 5 mit Profilylinder der Fa. Dom, Art.-Nr.: 25 500 91 sowie mit verdeckt liegendem Band der Fa. Tebau.	
Verglasung	nach DIN 52290 - B1	
Paneel	nach DIN 52290 - B3	
Montage	Montageanleitung Stand Januar 2001, Blatt 1	
Ausführungsvarianten	- Abweichungen von der geprüften Größe gemäß DIN V ENV 1627 in der Breite maximal + 10% und - 20 % und in der Höhe maximal + 10% und - 20 %. - weitere Ausführungsvarianten siehe Anlage 1, Blatt 1	
<b>Ergebnis</b>	Der Probekörper erfüllt die Anforderungen an einbruchhemmende Türen der	
	<b>Widerstandsklasse 3 nach DIN V ENV 1627 : 1999</b>	
<b>Verwendung von ift-Prüfberichten</b>	Entsprechend dem ift-Merkblatt und nur so lange, wie sich die Bauart des Produktes sowie der Inhalt und die Gültigkeit der Norm nicht ändern.	
<b>ift Rosenheim</b> 20. September 2001		
Dr. Helmut Hohenstein Institutsleiter	i. A. Christian Kehrer Leiter Prüffeld Türen, Tore, Sicherheit	
<small>Institut für Fenstertechnik e. V. Leiter: Dr. Helmut Hohenstein Theodor-Gießl-Str. 7-9 83026 Rosenheim</small>	<small>Telefon +49 (0) 8031 261-0 Telefax +49 (0) 8031 261-290 e-mail info@ift-rosenheim.de http://www.ift-rosenheim.de</small>	<small>Sparkasse Rosenheim: Kto. 38 22 (BLZ 711 500 00) Postcheckamt München: Kto. 2949 26-801 (BLZ 700 100 80)</small>
		<small>Deutscher Anzeigerungs- Rat <b>DAR</b> DAP-PL-0808 01</small>

**CLASS  
3**



**Multiblindo classic**

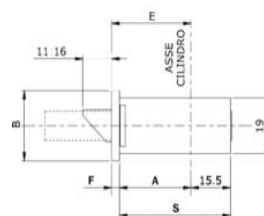
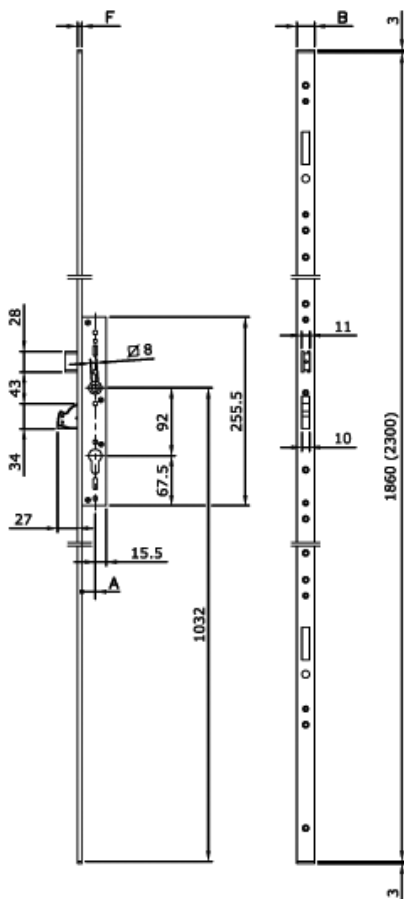

Codice						
Art.	E	A	S	B	F	
79** 10	25	2	22	37.5	24	3
	30		27	42.5		
	35		32	47.5		
	40		37	52.5		

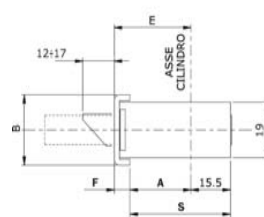

Codice						
Art.	E	A	S	B	F	
79** 00	25	2	18	33.5	24	6
	30		23	38.5		
	35		28	43.5		
	40		33	48.5		
01	25		18	33.5		
	30		23	38.5		
	35		28	43.5		
	40		33	48.5		

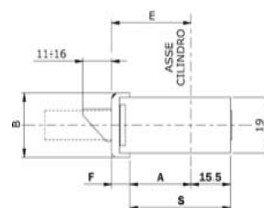

Codice						
Art.	E	A	S	B	F	
79** 50	25	0	18	33.5	22	7
	30		23	38.5		
	35		28	43.5		
	40		33	48.5		



MULTIBLINDO mortice lock for metal frames, 3-POINT LOCKING, **MODULAR, ROTATING DEADBOLT.**

Central lock, centre distance mm 92, operating with European profile cylinder.

Front plate with holes for additional deviators. Rotating deadbolt, mm 27 throw with antidrill/anticut cover plates in carbonitrided steel.

Supplied with reversible and adjustable latchbolt. The latchbolt can be replaced with roller or cap for deadlocking only. Latchbolt/roller retainer by key or mm 8 handle follower.

Built-in connecting rods between lock and deviators. 2 nylon end blocks for U-version.

Fixing screws. Instruction sheet.

**Accessories to be ordered separately:**

- Rotating deadbolt deviator - ref. N. 790330000
- Rotating hook deviator - ref. N. 790340000
- Bottom-locking deviator - ref. N. 790310000
- Top-locking deviator - ref. N. 790320000
- Modular roller for latchbolt hole - ref. N.. 040801/2/3/4
- Modular cap for latchbolt hole - ref. N.. 040810
- Cylinder escutcheon - ref. N.. 040809
- Anti-drill plate - ref. N. 040805. 25/30/35/40
- Striking plates



Code

Status  
Single  
package  
Multiple  
package  
Min. ord.

## Multiblindo classic

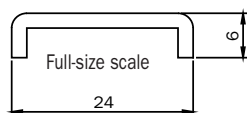

U-front plate mm <b>2300 x 24 x 6</b> in <b>stainless steel</b> . Backset mm 25	<b>799100252</b>	A	1	-	1
U-front plate mm <b>2300 x 24 x 6</b> in <b>stainless steel</b> . Backset mm 30	<b>799100302</b>	A	1	-	1
U-front plate mm <b>2300 x 24 x 6</b> in <b>stainless steel</b> . Backset mm 35	<b>799100352</b>	A	1	-	1
U-front plate mm <b>2300 x 24 x 6</b> in <b>stainless steel</b> . Backset mm 40	<b>799100402</b>	B	1	-	1

U-front plate mm <b>1860 x 24 x 6</b> in <b>stainless steel</b> . Backset mm 25	<b>799101252</b>	D	1	-	1
U-front plate mm <b>1860 x 24 x 6</b> in <b>stainless steel</b> . Backset mm 30	<b>799101302</b>	B	1	-	1
U-front plate mm <b>1860 x 24 x 6</b> in <b>stainless steel</b> . Backset mm 35	<b>799101352</b>	B	1	-	1
U-front plate mm <b>1860 x 24 x 6</b> in <b>stainless steel</b> . Backset mm 40	<b>799101402</b>	C	1	-	1

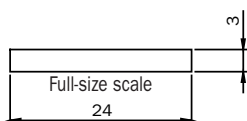

Flat front plate mm <b>2300 x 24 x 3</b> in <b>stainless steel</b> . Backset mm 25	<b>799110252</b>	C	1	-	1
Flat front plate mm <b>2300 x 24 x 3</b> in <b>stainless steel</b> . Backset mm 30	<b>799110302</b>	B	1	-	1
Flat front plate mm <b>2300 x 24 x 3</b> in <b>stainless steel</b> . Backset mm 35	<b>799110352</b>	A	1	-	1
Flat front plate mm <b>2300 x 24 x 3</b> in <b>stainless steel</b> . Backset mm 40	<b>799110402</b>	B	1	-	1

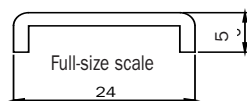

U-front plate mm <b>2300 x 24 x 5</b> in <b>stainless steel</b> . Backset mm 25	<b>799130252</b>	B	1	-	1
U-front plate mm <b>2300 x 24 x 5</b> in <b>stainless steel</b> . Backset mm 30	<b>799130302</b>	C	1	-	1
U-front plate mm <b>2300 x 24 x 5</b> in <b>stainless steel</b> . Backset mm 35	<b>799130352</b>	B	1	-	1
U-front plate mm <b>2300 x 24 x 5</b> in <b>stainless steel</b> . Backset mm 40	<b>799130402</b>	B	1	-	1

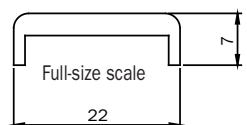

U-front plate mm <b>2300 x 22 x 7</b> in black painted <b>aluminium</b> . Backset mm 25	<b>799150250</b>	D	1	-	1
U-front plate mm <b>2300 x 22 x 7</b> in black painted <b>aluminium</b> . Backset mm 30	<b>799150300</b>	C	1	-	1
U-front plate mm <b>2300 x 22 x 7</b> in black painted <b>aluminium</b> . Backset mm 35	<b>799150350</b>	B	1	-	1
U-front plate mm <b>2300 x 22 x 7</b> in black painted <b>aluminium</b> . Backset mm 40	<b>799150400</b>	D	1	-	1





Code

Status  
Single  
package  
Multiple  
package  
Min. ord.

## Multiblindo classic

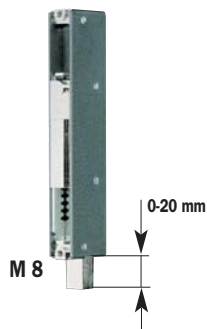

DEVIATOR FOR MULTIBLINDO, lower locking, to be applied on the modular front plate.

M8 threaded square for tip bolt. Multi-faceted, anti-screw **TIP BOLT D 14 X 55** with threaded hole M8, tip length mm 20. Antidust brass rod cap D 18. Screws and pins.

**Accessories to be ordered separately:**

Floor socket 040807

**790310000** C 1 10 10

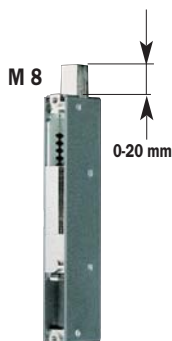

DEVIATOR FOR MULTIBLINDO, upper locking, to be applied on the modular front plate.

M8 threaded square for tip bolt. Multi-faceted, anti-screw **TIP BOLT D 14 X 55** with threaded hole M8, tip length mm 20. Zinc-plated plate and nylon tip-guiding spacer. Screws and pins.

**Accessories to be ordered separately:**

Upper striker 040806

**790320000** B 1 10 10



DEVIATOR FOR MULTIBLINDO, lateral locking, to be applied on the modular front plate. **ROTATING DEADBOLT**

27 mm throw with antidrill and anticut cover plates in carbonitrided steel. Screws.

**Accessories to be ordered separately:**

Striking plates

**790330000** A 1 10 10



DEVIATOR FOR MULTIBLINDO, lateral locking, to be applied on the modular front plate. **ROTATING HOOK,**

clearance mm 15,5 and mm 26,5 throw with antidrill and anticut cover plates in carbonitrided steel and translating latchbolt. Screws.

**Accessories to be ordered separately:**

Striking plates

**790340000** A 1 10 10



**Multiblindo classic**

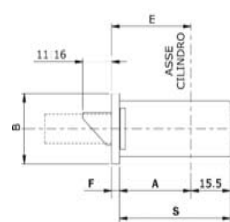
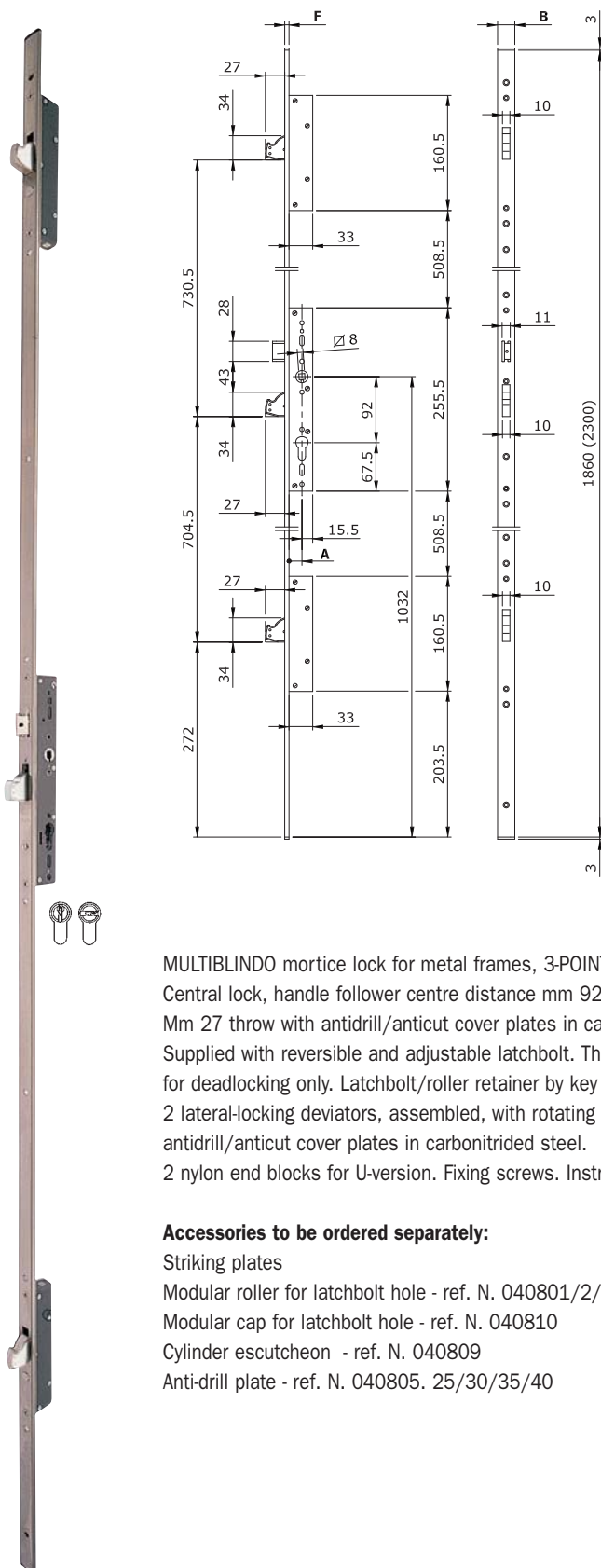

Codice						
Art.	E	A	S	B	F	
79** 10	25	2	22	37.5	24	3
	30		27	42.5		
	35		32	47.5		
	40		37	52.5		

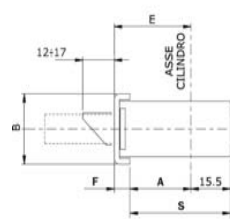

Codice						
Art.	E	A	S	B	F	
79** 00	25	2	18	33.5	24	6
	30		23	38.5		
	35		28	43.5		
	40		33	48.5		
01	25		18	33.5		
	30		23	38.5		
	35		28	43.5		
	40		33	48.5		

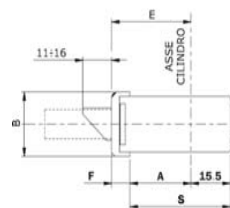

Codice						
Art.	E	A	S	B	F	
79** 50	25	0	18	33.5	22	7
	30		23	38.5		
	35		28	43.5		
	40		33	48.5		

MULTIBLINDO mortice lock for metal frames, 3-POINT LOCKING, **DEVIATORS, ROTATING DEADBOLT.**

Central lock, handle follower centre distance mm 92, operating with European profile cylinder.

Mm 27 throw with antidrill/anticut cover plates in carbonitrided steel.

Supplied with reversible and adjustable latchbolt. The latchbolt can be replaced with roller or cap for deadlocking only. Latchbolt/roller retainer by key or mm 8 handle follower.

2 lateral-locking deviators, assembled, with rotating deadbolt mm 27 throw with antidrill/anticut cover plates in carbonitrided steel.

2 nylon end blocks for U-version. Fixing screws. Instruction sheet.

**Accessories to be ordered separately:**

Striking plates

Modular roller for latchbolt hole - ref. N. 040801/2/3/4

Modular cap for latchbolt hole - ref. N. 040810

Cylinder escutcheon - ref. N. 040809

Anti-drill plate - ref. N. 040805. 25/30/35/40



Code

Status  
Single  
package  
Multiple  
package  
Min. ord.

## Multiblindo classic

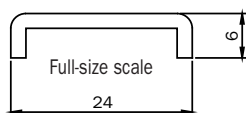

U-front plate mm <b>2300 x 24 x 6</b> in <b>stainless steel</b> . Backset mm 25	<b>795100252</b>	B	1	-	1
U-front plate mm <b>2300 x 24 x 6</b> in <b>stainless steel</b> . Backset mm 30	<b>795100302</b>	B	1	-	1
U-front plate mm <b>2300 x 24 x 6</b> in <b>stainless steel</b> . Backset mm 35	<b>795100352</b>	B	1	-	1
U-front plate mm <b>2300 x 24 x 6</b> in <b>stainless steel</b> . Backset mm 40	<b>795100402</b>	B	1	-	1

U-front plate mm <b>1860 x 24 x 6</b> in <b>stainless steel</b> . Backset mm 25	<b>795101252</b>	B	1	-	1
U-front plate mm <b>1860 x 24 x 6</b> in <b>stainless steel</b> . Backset mm 30	<b>795101302</b>	B	1	-	1
U-front plate mm <b>1860 x 24 x 6</b> in <b>stainless steel</b> . Backset mm 35	<b>795101352</b>	A	1	-	1
U-front plate mm <b>1860 x 24 x 6</b> in <b>stainless steel</b> . Backset mm 40	<b>795101402</b>	A	1	-	1

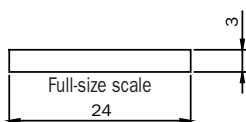

Flat front plate mm <b>2300 x 24 x 3</b> in <b>stainless steel</b> . Backset mm 25	<b>795110252</b>	B	1	-	1
Flat front plate mm <b>2300 x 24 x 3</b> in <b>stainless steel</b> . Backset mm 30	<b>795110302</b>	A	1	-	1
Flat front plate mm <b>2300 x 24 x 3</b> in <b>stainless steel</b> . Backset mm 35	<b>795110352</b>	A	1	-	1
Flat front plate mm <b>2300 x 24 x 3</b> in <b>stainless steel</b> . Backset mm 40	<b>795110402</b>	B	1	-	1

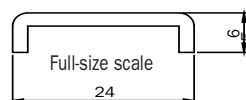

U-front plate mm <b>2300 x 24 x 5</b> in <b>stainless steel</b> . Backset mm 25	<b>795130252</b>	D	1	-	1
U-front plate mm <b>2300 x 24 x 5</b> in <b>stainless steel</b> . Backset mm 30	<b>795130302</b>	D	1	-	1
U-front plate mm <b>2300 x 24 x 5</b> in <b>stainless steel</b> . Backset mm 35	<b>795130352</b>	C	1	-	1
U-front plate mm <b>2300 x 24 x 5</b> in <b>stainless steel</b> . Backset mm 40	<b>795130402</b>	D	1	-	1

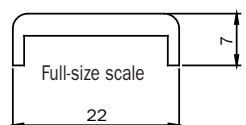

U-front plate mm <b>2300 x 22 x 7</b> in black painted <b>aluminium</b> . Backset mm 25	<b>795150250</b>	C	1	-	1
U-front plate mm <b>2300 x 22 x 7</b> in black painted <b>aluminium</b> . Backset mm 30	<b>795150300</b>	B	1	-	1
U-front plate mm <b>2300 x 22 x 7</b> in black painted <b>aluminium</b> . Backset mm 35	<b>795150350</b>	A	1	-	1
U-front plate mm <b>2300 x 22 x 7</b> in black painted <b>aluminium</b> . Backset mm 40	<b>795150400</b>	D	1	-	1



**Multiblindo classic**

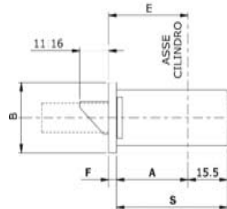
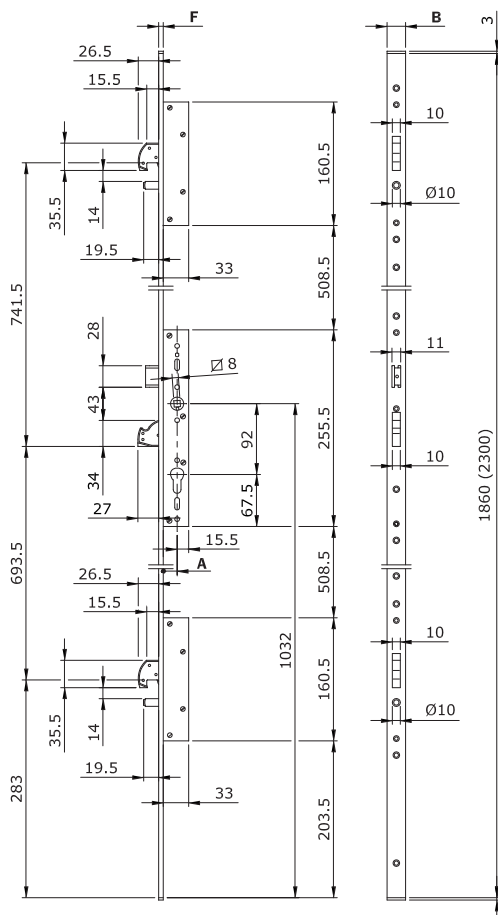

Codice						
Art.	E	A	S	B	F	
79** 10	25	2	22	37.5	24	3
	30		27	42.5		
	35		32	47.5		
	40		37	52.5		

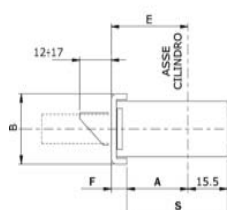

Codice						
Art.	E	A	S	B	F	
79** 00	25	2	18	33.5	24	6
	30		23	38.5		
	35		28	43.5		
	40		33	48.5		
01	25		18	33.5		
	30		23	38.5		
	35		28	43.5		
	40		33	48.5		

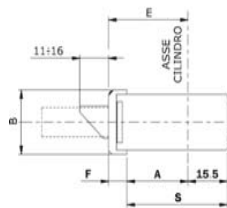

Codice						
Art.	E	A	S	B	F	
79** 50	25	0	18	33.5	22	7
	30		23	38.5		
	35		28	43.5		
	40		33	48.5		



MULTIBLINDO mortice lock for metal frames, 3-POINT LOCKING, **ROTATING HOOK DEVIATORS**.  
 Central lock, handle follower centre distance mm 92, operating with European profile cylinder.  
 Rotating deadbolt, mm 27 throw, with antidrill/anticut cover plates in carbonitrided steel.  
 Supplied with reversible and adjustable latchbolt. The latchbolt can be replaced with roller or cap  
 for deadlocking only. Latchbolt/roller retainer by key or mm 8 handle follower. Cylinder screw.  
 2 nylon end blocks for U-version. Instruction sheet.

**Accessories to be ordered separately:**

- Striking plates
- Modular roller for latchbolt hole - ref. N. 040801/2/3/4
- Modular cap for latchbolt hole - ref. N. 040801
- Cylinder escutcheon - ref. N. 040809
- Antidrill plate - ref. N. 040805. 25/30/35/40



Code

Status  
Single  
package  
Multiple  
package  
Min. ord.

## Multiblindo classic

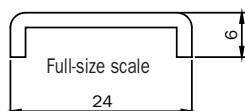

U-front plate mm <b>2300 x 24 x 6</b> in <b>stainless steel</b> . Backset mm 25	<b>795500252</b>	B	1	-	1
U-front plate mm <b>2300 x 24 x 6</b> in <b>stainless steel</b> . Backset mm 30	<b>795500302</b>	B	1	-	1
U-front plate mm <b>2300 x 24 x 6</b> in <b>stainless steel</b> . Backset mm 35	<b>795500352</b>	A	1	-	1
U-front plate mm <b>2300 x 24 x 6</b> in <b>stainless steel</b> . Backset mm 40	<b>795500402</b>	B	1	-	1

U-front plate mm <b>1860 x 24 x 6</b> in <b>stainless steel</b> . Backset mm 25	<b>795501252</b>	C	1	-	1
U-front plate mm <b>1860 x 24 x 6</b> in <b>stainless steel</b> . Backset mm 30	<b>795501302</b>	B	1	-	1
U-front plate mm <b>1860 x 24 x 6</b> in <b>stainless steel</b> . Backset mm 35	<b>795501352</b>	A	1	-	1
U-front plate mm <b>1860 x 24 x 6</b> in <b>stainless steel</b> . Backset mm 40	<b>795501402</b>	C	1	-	1

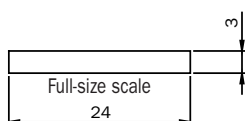

Flat front plate mm <b>2300 x 24 x 3</b> in <b>stainless steel</b> . Backset mm 25	<b>795510252</b>	D	1	-	1
Flat front plate mm <b>2300 x 24 x 3</b> in <b>stainless steel</b> . Backset mm 30	<b>795510302</b>	B	1	-	1
Flat front plate mm <b>2300 x 24 x 3</b> in <b>stainless steel</b> . Backset mm 35	<b>795510352</b>	A	1	-	1
Flat front plate mm <b>2300 x 24 x 3</b> in <b>stainless steel</b> . Backset mm 40	<b>795510402</b>	A	1	-	1

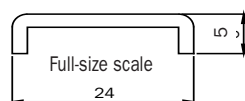

U-front plate mm <b>2300 x 24 x 5</b> in <b>stainless steel</b> . Backset mm 25	<b>795530252</b>	C	1	-	1
U-front plate mm <b>2300 x 24 x 5</b> in <b>stainless steel</b> . Backset mm 30	<b>795530302</b>	C	1	-	1
U-front plate mm <b>2300 x 24 x 5</b> in <b>stainless steel</b> . Backset mm 35	<b>795530352</b>	B	1	-	1
U-front plate mm <b>2300 x 24 x 5</b> in <b>stainless steel</b> . Backset mm 40	<b>795530402</b>	B	1	-	1

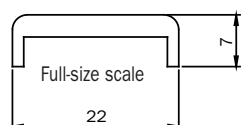

U-front plate mm <b>2300 x 22 x 7</b> in black painted <b>aluminium</b> . Backset mm 25	<b>795550250</b>	D	1	-	1
U-front plate mm <b>2300 x 22 x 7</b> in black painted <b>aluminium</b> . Backset mm 30	<b>795550300</b>	C	1	-	1
U-front plate mm <b>2300 x 22 x 7</b> in black painted <b>aluminium</b> . Backset mm 35	<b>795550350</b>	A	1	-	1
U-front plate mm <b>2300 x 22 x 7</b> in black painted <b>aluminium</b> . Backset mm 40	<b>795550400</b>	B	1	-	1



**Blindo**

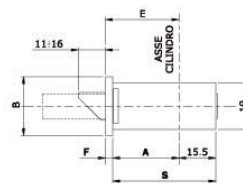
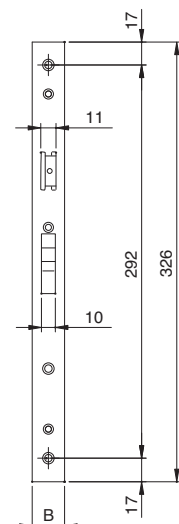
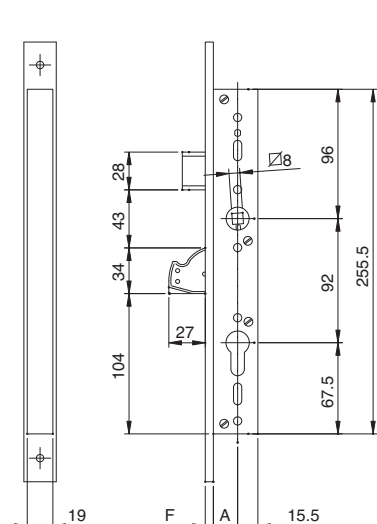

Codice							
Art.	E	A	S	B	F		
7911	10	25	2	22	37.5	24	3
	30			27	42.5		
	35			32	47.5		
	40			37	52.5		

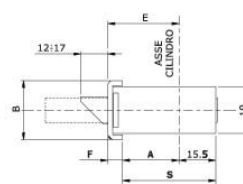

Codice							
Art.	E	A	S	B	F		
7911	00	25	2	18	33.5	24	6
	30			23	38.5		
	35			28	43.5		
	40			33	48.5		

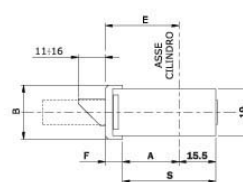

Codice							
Art.	E	A	S	B	F		
7911	50	25	0	18	33.5	22	7
	30			23	38.5		
	35			28	43.5		
	40			33	48.5		

BLINDO mortice lock for metal frames, LATERAL LOCKING, **ROTATING DEADBOLT**.

Centre distance mm 92, operating with European profile cylinder.

Rotating deadbolt, mm 27 throw, with antidrill/anticut cover plates in carbonitrided steel.

Supplied with reversible and adjustable latchbolt. The latchbolt can be replaced with roller or cap for deadlocking only. Latchbolt/roller retainer by key or mm 8 handle follower. Cylinder screw.

2 nylon end blocks for U-version. Instruction sheet.

**Accessories to be ordered separately:**

Striking plates

Modular roller for latchbolt hole - ref. N. 040801/2/3/4

Cylinder escutcheon - ref. N. 040809

Antidrill plate - ref. N. 040805. 25/30/35/40



Code

Status  
Single  
package  
Multiple  
package  
Min. ord.

## Blindo

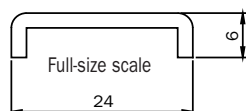

U-front plate mm <b>326 x 24 x 6</b> in <b>stainless steel</b> . Backset mm 25	<b>791100252</b>	C	1	10	10
U-front plate mm <b>326 x 24 x 6</b> in <b>stainless steel</b> . Backset mm 30	<b>791100302</b>	B	1	10	10
U-front plate mm <b>326 x 24 x 6</b> in <b>stainless steel</b> . Backset mm 35	<b>791100352</b>	B	1	10	10
U-front plate mm <b>326 x 24 x 6</b> in <b>stainless steel</b> . Backset mm 40	<b>791100402</b>	D	1	10	10

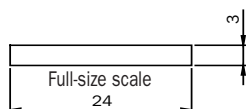

Flat front plate mm <b>326 x 24 x 3</b> in <b>stainless steel</b> . Backset mm 25	<b>791110252</b>	C	1	10	10
Flat front plate mm <b>326 x 24 x 3</b> in <b>stainless steel</b> . Backset mm 30	<b>791110302</b>	B	1	10	10
Flat front plate mm <b>326 x 24 x 3</b> in <b>stainless steel</b> . Backset mm 35	<b>791110352</b>	B	1	10	10
Flat front plate mm <b>326 x 24 x 3</b> in <b>stainless steel</b> . Backset mm 40	<b>791110402</b>	B	1	10	10

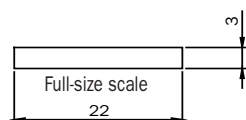

Flat front plate mm <b>326 x 22 x 3</b> in <b>stainless steel</b> . Backset mm 25	<b>791112252</b>	D	1	10	10
Flat front plate mm <b>326 x 22 x 3</b> in <b>stainless steel</b> . Backset mm 30	<b>791112302</b>	D	1	10	10
Flat front plate mm <b>326 x 22 x 3</b> in <b>stainless steel</b> . Backset mm 35	<b>791112352</b>	D	1	10	10
Flat front plate mm <b>326 x 22 x 3</b> in <b>stainless steel</b> . Backset mm 40	<b>791112402</b>	D	1	10	10

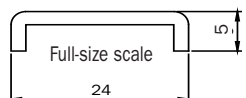

U-front plate mm <b>326 x 24 x 5</b> in <b>stainless steel</b> . Backset mm 25	<b>791133252</b>	D	1	10	10
U-front plate mm <b>326 x 24 x 5</b> in <b>stainless steel</b> . Backset mm 30	<b>791133302</b>	D	1	10	10
U-front plate mm <b>326 x 24 x 5</b> in <b>stainless steel</b> . Backset mm 35	<b>791133352</b>	D	1	10	10
U-front plate mm <b>326 x 24 x 5</b> in <b>stainless steel</b> . Backset mm 40	<b>791133402</b>	D	1	10	10

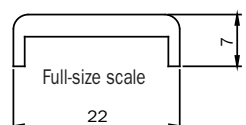

U-front plate mm <b>326 x 22 x 7</b> in black painted <b>aluminium</b> . Backset mm 25	<b>791150250</b>	D	1	10	10
U-front plate mm <b>326 x 22 x 7</b> in black painted <b>aluminium</b> . Backset mm 30	<b>791150300</b>	C	1	10	10
U-front plate mm <b>326 x 22 x 7</b> in black painted <b>aluminium</b> . Backset mm 35	<b>791150350</b>	B	1	10	10
U-front plate mm <b>326 x 22 x 7</b> in black painted <b>aluminium</b> . Backset mm 40	<b>791150400</b>	D	1	10	10



Code

Status  
Single  
package  
Multiple  
package  
Min. ord.

**Accessories for Multiblindo classic and Blindo**



Modular roller for MULTIBLINDO and BLINDO with a nylon insert for fixed striking plate and a nylon insert for adjustable striking plate.

For lock backset mm <b>25</b>	<b>040801</b>	C	10	-	10
For lock backset mm <b>30</b>	<b>040802</b>	B	10	-	10
For lock backset mm <b>35</b>	<b>040803</b>	A	10	-	10
For lock backset mm <b>40</b>	<b>040804</b>	B	10	-	10



Modular cap for MULTIBLINDO and BLINDO for all backsets. In NYLON. To be fitted instead of the latchbolt for only deadbolt versions. Screw.

	<b>040810</b>	B	10	-	10
--	---------------	---	----	---	----



Roller nylon insert for adjustable striking plates 0386\*. For locks series 78\*.

	<b>040880</b>	B	100	-	10
--	---------------	---	-----	---	----



MODULAR ANTIDRILL PLATE for MULTIBLINDO and BLINDO. To be fixed to the lock for pin protection.

For lock backset mm <b>30</b>	<b>040805.30</b>	D	10	-	10
For lock backset mm <b>30</b>	<b>040805.30</b>	C	10	-	10
For lock backset mm <b>35</b>	<b>040805.35</b>	B	10	-	10
For lock backset mm <b>40</b>	<b>040805.40</b>	D	10	-	10



UPPER STRIKER for MULTIBLINDO, vertical locking. 2 tip-guiding plates D14.

Rod-guiding nylon spacer.	<b>040806</b>	D	10	-	10
---------------------------	---------------	---	----	---	----

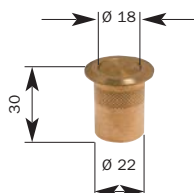

Brass FLOOR SOCKET with antidust spring cap for rods.

Inside hole D 18. For MULTIBLINDO	<b>040807</b>	C	10	-	10
-----------------------------------	---------------	---	----	---	----



Multi-faceted D 14 TIP for threaded rods M8. For MULTIBLINDO and BLINDO. In zinc-plated carbonitrided steel.

Elastic pin. Drawing pin.	<b>040808</b>	D	10	-	10
---------------------------	---------------	---	----	---	----

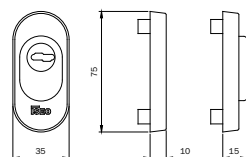
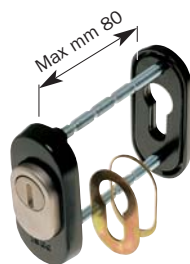

MODULAR ESCUTCHEON for MULTIBLINDO and BLINDO, European profile cylinder, internal fixing.

Internal and external escutcheons, in **BLACK painted aluminium**. External plate and antidrill disk in carbonitrided steel. Plate spacer. Spacers. Antidrill balls for screw protection. Screws.

	<b>040809</b>	B	1	-	1
--	---------------	---	---	---	---

MODULAR ESCUTCHEON for MULTIBLINDO and BLINDO, European profile cylinder, internal fixing.

Internal and external escutcheons, in aluminium. External plate and antidrill disk in **carbonitrided steel**.

Plate spacer. Spacers. Antidrill balls for screw protection. Screws.

	<b>040809G</b>	C	1	-	1
--	----------------	---	---	---	---



# Striking plates

For locks for metal frames series 79\*



Code

Min. ord.  
Multiple  
package  
Single  
package  
Status

## Multiblindo classic

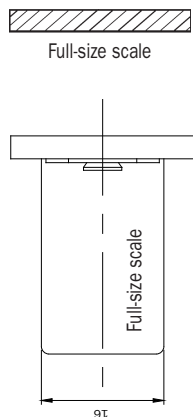

Closed striking plate for **CENTRAL LOCK MULTIBLINDO**. Flat front plate **220x24x3**. Can be used with mechanical striker 040890 or electric striker 040900-040910.

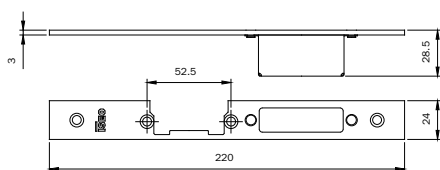

**RIGHT-HAND** adjustable **DIN LEFT**

**033160** B 1 10 10

**ALL.CO** All.Co 5 Porta / All.Co 5 TT Porta  
Export 50/50 TT Porta / Sicurblin 65  
**ALU-K** Alublindo / N 45 Porta / N 53 Porta / N 55 TT Porta  
N 62 TT Porta  
**ALU-MEC** Synthesis 57 Porta / Synthesis 60TT Porta  
**DOMAL** Stopper PG Porta  
**ESA** Blindal 60 Porta 1 Anta / 60 Porta 2 Ante  
**INDINVEST** Alpha 445 Porta 2 Ante  
**METRA** NC 45 International Porta  
NC 45 Superthermic Porta / NC 55 International Porta  
NC 68 Superthermic Porta / Nuovo NC 50 Porta  
Superblindo  
**PASSERINI** Ekip Blindo  
**SCHUCO** Royal 78 ST Blindato  
Royal S 50 N  
Royal S 55 TT  
Royal S 65 TT

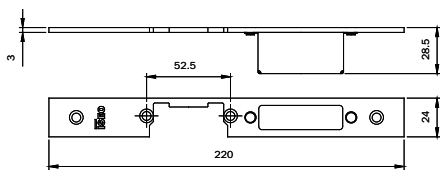

**LEFT-HAND** adjustable **DIN RIGHT**

**033161** C 1 10 10

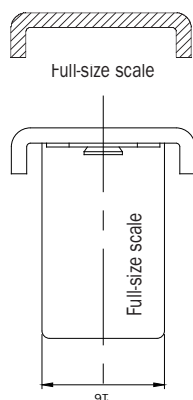

Closed striking plate for **CENTRAL LOCK MULTIBLINDO**. Material: stainless steel. U-front plate **220x24x6**. Can be used with mechanical striker 040890 or electric striker 040900-040910.

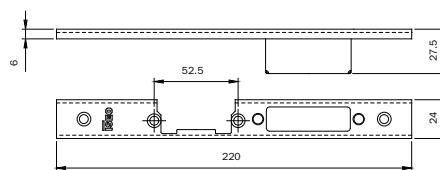

**RIGHT-HAND** adjustable **DIN LEFT**

**033162** B 1 1 10

**ALCAN** Abithal Keeper Porta 53-60 / 61-68  
Abithal Porta / Winner Porta  
**ALCOA** FB 12 Blindato Porta  
Plana 1 Anta / Plana 2 Ante  
**ALL.CO** All.Co 5 Porta / All.Co 5 TT Porta  
Export 50/50 TT Porta / Sicurblin 65  
**ALNOR** Montreal Porta  
**ALUSUISSE** Alsec 2000 Porta 59 / Alsec 2000 Porta 69  
**ALU-K** Alublindo / N 45 Porta / N 53 Porta / N 55 TT Porta  
N 62 TT Porta  
**ALU-MEC** Synthesis 57 Porta / Synthesis 60TT Porta  
**BODEGA** Extrablind 70  
**DOMAL** Domal Break 52 Porta / Domal Break 70 Porta  
Security Porta / Shops Porta / Stopper PG Porta  
**ESA** Blindal 60 Porta 1 Anta / 60 Porta 2 Ante  
Blindal 70 Porta 1 Anta / 70 Porta 2 Ante  
**FRESIA** Global 48 Porta  
**INDINVEST** Alpha 445 Porta 2 Ante  
**METRA** NC 45 International Porta  
NC 45 Superthermic Porta  
NC 55 International Porta  
NC 68 Superthermic Porta / Nuovo NC 50 Porta  
Superblindo  
**NEW TEC** New Tec 50 Porta Complanare  
**OCMA** SV 47 Porta 1 Anta  
SV 62 Porta 1 Anta  
SV 62 TT Porta 1 Anta  
**PASSERINI** Ekip Blindo  
Ekip Maastricht 53 Porta 1 Anta  
Ekip Maastricht 53 Porta 2 Ante  
Ekip Maastricht TH 60/68 Porta 1 Anta  
Ekip Maastricht TH 60/68 Porta 2 Ante  
Ekip Thermo 53 Porta  
**PROFILATI** PE \* Eku 53\* Porta  
PE \*Eku 64 TT \* Porta  
PE \*Eku 72 Tt \* Porta  
Sistema 1 PE 40 Complanare /Esterno 2 Ante  
Sistema 1 PE 40 Sormonto 2 Ante  
**SCHUCO** Royal 78 ST Blindato  
Royal S 50 N  
Royal S 55 TT  
Royal S 65 TT  
**WICONA** L60A / L70-A

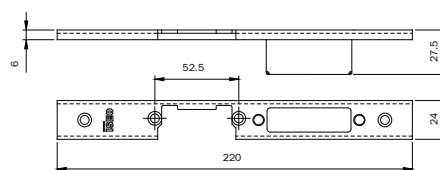

**LEFT-HAND** adjustable **DIN RIGHT**

**033163** B 1 1 10

**For locks for metal frames  
series 79\***



Code

Min. ord.  
Multiple  
package  
Single  
package  
Status

**Multiblindo classic**

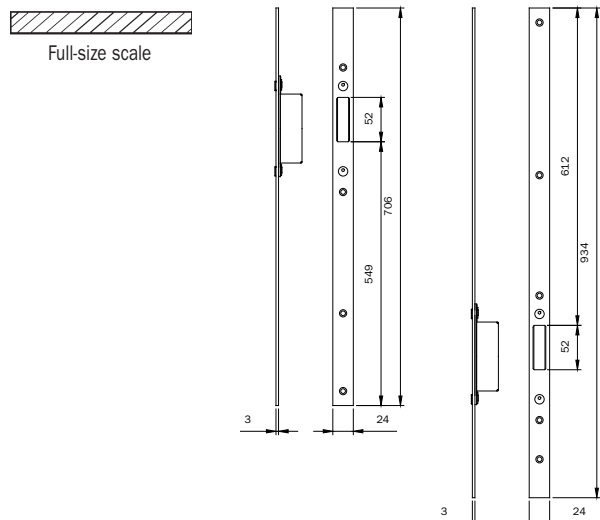

- ALL.CO All.Co 5 Porta / All.Co 5 TT Porta
- Export 50/50 TT Porta / Sicurblin 65
- ALU-K Alublindo / N 45 Porta / N 53 Porta / N 55 TT Porta
- N 62 TT Porta
- ALU-MEC Synthesis 57 Porta / Synthesis 60TT Porta
- DOMAL Stopper PG Porta
- ESA Blindal 60 Porta 1 Ante / 60 Porta 2 Ante
- INDINVEST Alpha 445 Porta 2 Ante
- METRA NC 45 International Porta
- NC 45 Superthermic Porta / NC 55 International Porta
- NC 68 Superthermic Porta / Nuovo NC 50 Porta
- Superblindo
- PASSERINI Ekip Blindo
- SCHÜCO Royal 78 ST Blindato
- Royal S 50 N
- Royal S 55 TT
- Royal S 65 TT

Pair of **ADJUSTABLE** closed striking plates  
for top/bottom **DEADBOLT DEVIATORS**  
MULTIBLINDO. Material: stainless steel.  
Flat front plate **1860x24x3**.  
Can be used with central striking plates  
033160-033161

**033164** D 1 10 10

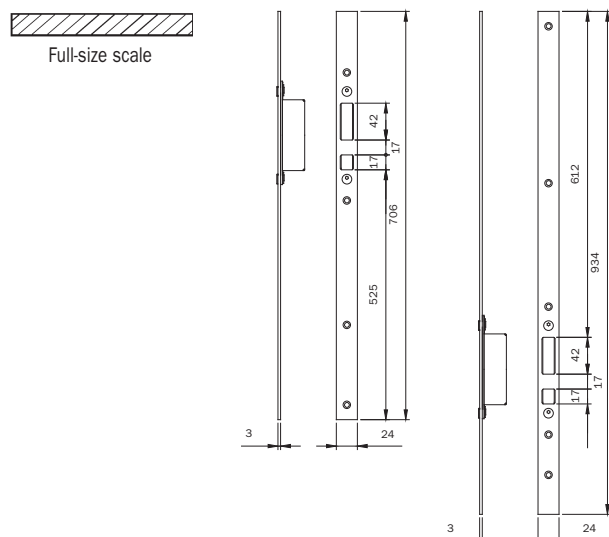

- ALL.CO All.Co 5 Porta / All.Co 5 TT Porta
- Export 50/50 TT Porta / Sicurblin 65
- ALU-K Alublindo / N 45 Porta / N 53 Porta / N 55 TT Porta
- N 62 TT Porta
- ALU-MEC Synthesis 57 Porta / Synthesis 60TT Porta
- DOMAL Stopper PG Porta
- ESA Blindal 60 Porta 1 Ante / 60 Porta 2 Ante
- INDINVEST Alpha 445 Porta 2 Ante
- METRA NC 45 International Porta
- NC 45 Superthermic Porta / NC 55 International Porta
- NC 68 Superthermic Porta / Nuovo NC 50 Porta
- Superblindo
- PASSERINI Ekip Blindo
- SCHÜCO Royal 78 ST Blindato
- Royal S 50 N
- Royal S 55 TT
- Royal S 65 TT

Pair of **ADJUSTABLE** closed striking plates for top/bottom  
**HOOK DEVIATORS** MULTIBLINDO. Material: stainless steel.  
Flat front plate **1860x24x3**.  
Can be used with central striking plates 033160-033161

**033165** D 1 10 10

**For locks for metal frames  
series 79\***



Code

Min. ord.  
Multiple  
package  
Single  
package  
Status

**Multiblindo classic**

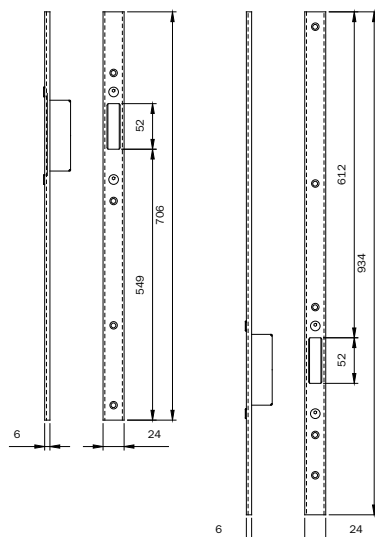
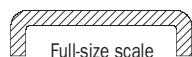

- ALCAN Abithal Keeper Porta 53-60 / 61-68
- Abithal Porta / Winner Porta
- ALCOA FB 12 Blindato Porta
- Plana 1 Anta / Plana 2 Ante
- ALL.CO All.Co 5 Porta / All.Co 5 TT Porta
- Export 50/50 TT Porta / Sicurblin 65
- ALNOR Montreal Porta
- ALUSUISSE Alsec 2000 Porta 59 / Alsec 2000 Porta 69
- ALU-K Alublindo / N 45 Porta / N 53 Porta / N 55 TT Porta
- N 62 TT Porta
- ALU-MEC Synthesis 57 Porta / Synthesis 60TT Porta
- BODEGA Extrablind 70
- DOMAL Domal Break 52 Porta / Domal Break 70 Porta
- Security Porta / Shops Porta / Stopper PG Porta
- ESA Blindal 60 Porta 1 Anta / 60 Porta 2 Ante
- Blindal 70 Porta 1 Anta / 70 Porta 2 Ante
- FRESIA Global 48 Porta
- INDINVEST Alpha 445 Porta 2 Ante
- METRA NC 45 International Porta
- NC 45 Superthermic Porta / NC 55 International Porta
- NC 68 Superthermic Porta / Nuovo NC 50 Porta
- Superblindo
- NEW TEC New Tec 50 Porta Complanare
- OCMA SV 47 Porta 1 Anta
- SV 62 Porta 1 Anta
- SV 62 TT Porta 1 Anta
- PASSERINI Ekip Blindo
- Ekip Maastricht 53 Porta 1 Anta
- Ekip Maastricht 53 Porta 2 Ante
- Ekip Maastricht TH 60/68 Porta 1 Anta
- Ekip Maastricht TH 60/68 Porta 2 Ante
- Ekip Thermo 53 Porta
- PROFILATI PE "Eku 53" Porta
- PE "Eku 64 TT" Porta
- PE "Eku 72 Tt" Porta
- Sistema 1 PE 40 Complanare /Esterno 2 Ante
- Sistema 1 PE 40 Sormonto 2 Ante
- SCHUCO Royal 78 ST Blindato
- Royal S 50 N
- Royal S 55 TT
- Royal S 65 TT
- WICONA L60A / L70A

Pair of **ADJUSTABLE** closed striking plates for  
top/bottom **DEADBOLT DEVIATORS** MULTIBLINDO.  
Material: stainless steel. U-front plate **1860x24x6**.  
Can be used with central striking plates  
033162-033163

**033166** C 1 10 10

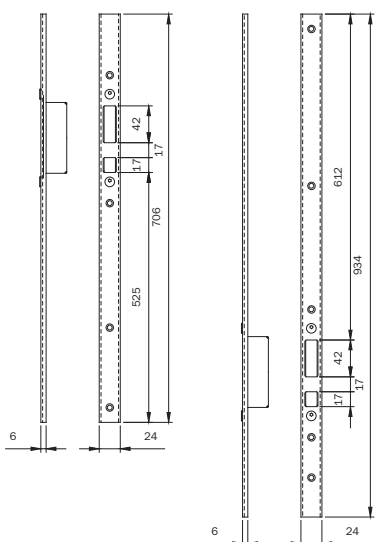

- ALCAN Abithal Keeper Porta 53-60 / 61-68
- Abithal Porta / Winner Porta
- ALCOA FB 12 Blindato Porta
- Plana 1 Anta / Plana 2 Ante
- ALL.CO All.Co 5 Porta / All.Co 5 TT Porta
- Export 50/50 TT Porta / Sicurblin 65
- ALNOR Montreal Porta
- ALUSUISSE Alsec 2000 Porta 59 / Alsec 2000 Porta 69
- ALU-K Alublindo / N 45 Porta / N 53 Porta / N 55 TT Porta
- N 62 TT Porta
- ALU-MEC Synthesis 57 Porta / Synthesis 60TT Porta
- BODEGA Extrablind 70
- DOMAL Domal Break 52 Porta / Domal Break 70 Porta
- Security Porta / Shops Porta / Stopper PG Porta
- ESA Blindal 60 Porta 1 Anta / 60 Porta 2 Ante
- Blindal 70 Porta 1 Anta / 70 Porta 2 Ante
- FRESIA Global 48 Porta
- INDINVEST Alpha 445 Porta 2 Ante
- METRA NC 45 International Porta
- NC 45 Superthermic Porta / NC 55 International Porta
- NC 68 Superthermic Porta / Nuovo NC 50 Porta
- Superblindo
- NEW TEC New Tec 50 Porta Complanare
- OCMA SV 47 Porta 1 Anta
- SV 62 Porta 1 Anta
- SV 62 TT Porta 1 Anta
- PASSERINI Ekip Blindo
- Ekip Maastricht 53 Porta 1 Anta
- Ekip Maastricht 53 Porta 2 Ante
- Ekip Maastricht TH 60/68 Porta 1 Anta
- Ekip Maastricht TH 60/68 Porta 2 Ante
- Ekip Thermo 53 Porta
- PROFILATI PE "Eku 53" Porta
- PE "Eku 64 TT" Porta
- PE "Eku 72 Tt" Porta
- Sistema 1 PE 40 Complanare /Esterno 2 Ante
- Sistema 1 PE 40 Sormonto 2 Ante
- SCHUCO Royal 78 ST Blindato
- Royal S 50 N
- Royal S 55 TT
- Royal S 65 TT
- WICONA L60A / L70A

Pair of **ADJUSTABLE** closed striking plates for  
top/bottom **HOOK DEVIATORS** MULTIBLINDO.  
Material: stainless steel.  
U-front plate **1860x24x6**.  
Can be used with central striking plates  
033162-033163

**033167** C 1 10 10

**For locks for metal frames series 79\***



Code

Min. ord.  
Multiple package  
Single package  
Status

**Multiblindo classic**



Full-size scale

Pair of **ADJUSTABLE** closed striking plates for top/bottom MULTIBLINDO. Material: stainless steel. Flat front plate **180x24x3**. Can be used with central striking plates 033160-033161

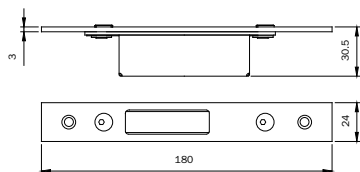

**ALL.CO** All.Co 5 Porta / All.Co 5 TT Porta  
Export 50/50 TT Porta / Scirubin 65  
**ALU-K** Alublindo / N 45 Porta / N 53 Porta / N 55 TT Porta  
N 62 TT Porta  
**ALU-MEC** Synthesis 57 Porta / Synthesis 60TT Porta  
**DOMAL** Stopper PG Porta  
**ESA** Blindal 60 Porta 1 Anta / 60 Porta 2 Ante  
**INDINVEST** Alpha 445 Porta 2 Ante  
**METRA** NC 45 International Porta  
NC 45 Superthermic Porta / NC 55 International Porta  
NC 68 Superthermic Porta / Nuovo NC 50 Porta  
Superblindo  
**PASSERINI** Ekip Blindo  
**SCHUCO** Royal 78 ST Blindato  
Royal S 50 N  
Royal S 55 TT  
Royal S 65 TT

**DEADBOLT DEVIATORS**

**033168** C 1 10 10



Full-size scale

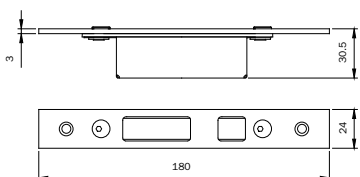

**HOOK DEVIATORS**

**033169** C 1 10 10

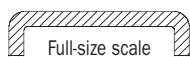

Full-size scale

Pair of **ADJUSTABLE** closed striking plates for top/bottom MULTIBLINDO. Material: stainless steel. U front plate **180x24x6**. Can be used with central striking plates 0331162-0331163.

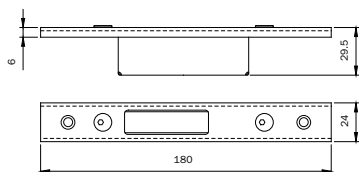

**ALCAN** Abithal Keeper Porta 53/60 / 61-68  
Abithal Porta / Winner Porta  
**ALCOA** FB 12 Blindato Porta  
Plana 1 Anta / Plana 2 Ante  
**ALL.CO** All.Co 5 Porta / All.Co 5 TT Porta  
Export 50/50 TT Porta / Scirubin 65  
**ALNOR** Montreal Porta  
**ALUSUISSE** Alsec 2000 Porta 59 / Alsec 2000 Porta 69  
**ALU-K** Alublindo / N 45 Porta / N 53 Porta / N 55 TT Porta  
N 62 TT Porta  
**ALU-MEC** Synthesis 57 Porta / Synthesis 60TT Porta  
**BODEGA** Extrablind 70  
**DOMAL** Domal Break 52 Porta / Domal Break 70 Porta  
Security Porta / Shops Porta / Stopper PG Porta  
**ESA** Blindal 60 Porta 1 Anta / 60 Porta 2 Ante  
Blindal 70 Porta 1 Anta / 70 Porta 2 Ante  
**FRESIA** Global 48 Porta  
**INDINVEST** Alpha 445 Porta 2 Ante  
**METRA** NC 45 International Porta  
NC 45 Superthermic Porta / NC 55 International Porta  
NC 68 Superthermic Porta / Nuovo NC 50 Porta  
Superblindo  
**NEW TEC** New Tec 50 Porta Complanare  
**OCMA** SV 47 Porta 1 Anta  
SV 62 Porta 1 Anta  
SV 62 TT Porta 1 Anta  
**PASSERINI** Ekip Blindo  
Ekip Maastricht 53 Porta 1 Anta  
Ekip Maastricht 53 Porta 2 Ante  
Ekip Maastricht TH 60/68 Porta 1 Anta  
Ekip Maastricht TH 60/68 Porta 2 Ante  
Ekip Thermo 53 Porta  
**PROFILATI** PE "Eku 53" Porta  
PE "Eku 64 TT" Porta  
PE "Eku 72 TT" Porta  
Sistema 1 PE 40 Complanare / Esterno 2 Ante  
Sistema 1 PE 40 Sormonto 2 Ante  
**SCHUCO** Royal 78 ST Blindato  
Royal S 50 N  
Royal S 55 TT  
Royal S 65 TT  
**WICONA** L60A / L70A

**DEADBOLT DEVIATORS**

**033170** C 1 10 10

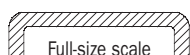

Full-size scale

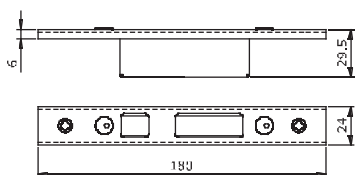

**HOOK DEVIATORS**

**033171** B 1 10 10

**For locks for metal frames series 79\***



Code

Min. ord.  
Multiple package  
Single package  
Status

**Multiblindo classic**

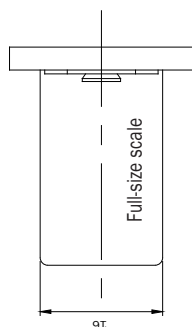
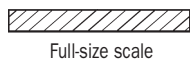

Closed striking plate for **CENTRAL LOCK** MULTIBLINDO. Material: stainless steel.

Flat front plate **220x22x3**.

Can be used with mechanical striker 040890 or electric striker 040900-040910.

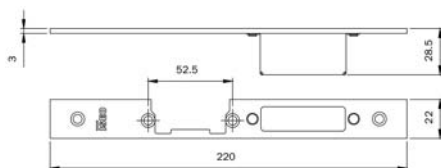

**RIGHT- HAND** adjustable **DIN LEFT**

- ALCAN : Abithal Cristal / Abithal Keeper porta C.E. / Winner finestra
- ALCOA : FB 12 GA / Europa GA / FB 12 TT / R 35 reversibile R 35 sormonto
- ALLCO : All.Co 5 complanare / Export 40 finestra Export 45 TT finestra / Export 50 finestra / Export 50 TT finestra Final 40 finestra / Ites P4 complanare / Sciburbin C.E.
- ALNOR : Blindo Block / Montreal G.A.
- ALUK : N53 complanare / N 55 TT complanare
- ALU-MEC : Synthesis 45 finestra / Synthesis 57 finestra Synthesis 60 TT finestra
- ALUSUISSE : Alsec 2000 finestra 59 / Alsec 2000 finestra 69
- BODEGA : BGA 50 / New BT 60
- DOMAL : Domal Break 52 finestra / Domal Break 70 finestra Domal Stopper PG finestra
- EQUIPE : Sistema 8000 G.A. finestra 1 ante Sistema 8000 G.A. finestra 2 ante / Sistema 8000 TT finestra 1 ante Sistema 8000 TT finestra 2 ante
- ESA : Giuntall complanare / Giuntall porta / Isola porta
- ESEDRA : GA 53 porta / TT 63 porta / TT 75 porta
- INDINVEST : Alpha 255 complanare Alpha 370 TT complanare Alpha 445 finestra / Alpha 445 porta 1 ante Alpha 658 TT complanare / Alpha Blitz 2000 Alpha Globo 45 / Alpha Globo 55 / Gold 400 complanare Gold 400 sormonto / Gold 500 complanare / Gold 500 sormonto / Gold 600 complanare / Gold 600 sormonto
- METRA : NC 45 International finestra / NC 45 Superthermic finestra NC 55 International finestra / NC 68 Superthermic finestra Nuovo NC 40 complanare / Nuovo NC 40 sormonto 2 ante Nuovo NC 50 complanare
- MORELLI : MA 8300
- OCMA : FC 47 finestra / FC 55 finestra / FC 60 TT finestra
- PASSERINI : Ekip 40 complanare 2 ante Ekip 40 evoluzione 2 ante Ekip 40 sormonto 2 ante / Ekip 50 complanare 2 ante Ekip 50 sormonto 2 ante / Ekip Maastricht 53 finestra Ekip Maastricht TH 60 finestra / Ekip Maastricht TH 68 finestra Ekip Thermo 53 finestra 2 ante
- PROFILATI : PE Eku 53 finestra\* / PE Eku 64 TT\* finestra\* PE Eku 72 TT\* finestra\* / Sistema 1 PE 50 comp. est. 2 ante Sistema 1 PE 50 sormonto 2 ante

**033173** D 1 10 10

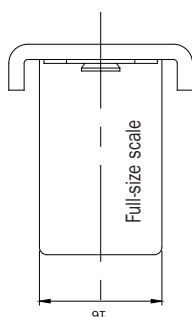
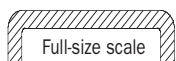

Closed striking plate for **CENTRAL LOCK** MULTIBLINDO. Material: **ALUMINIUM**.

U-front plate **220x22x7**. Can be used with mechanical striker 040890 or electric striker 040900-040910.

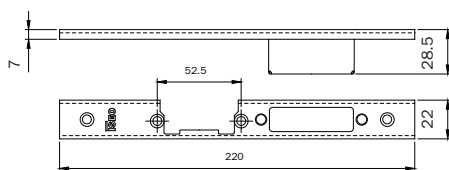

**RIGHT- HAND** adjustable **DIN LEFT**

- ALCAN : Abithal Keeper porta 53-60 / 61-68 Abithal porta / Winner orta
- ALCOA : FB 12 Blindato porta Plana 1 ante / Plana 2 ante
- ALLCO : All.co 5 porta / All.co 5 TT porta Export 50/50 TT porta / Sciburbin 65
- ALNOR : Montreal porta
- ALUSUISSE : Alsec 2000 porta 59 / Alsec 2000 porta 69
- ALU-K : Alublindo / N 45 porta / N 53 porta / N 55 TT porta N 62 TT porta
- ALU-MEC : Synthesis 57 porta / Synthesis 60TT porta
- BODEGA : Extrablind 70
- DOMAL : Domal Break 52 porta / Domal Break 70 porta Security porta / Shops porta / Stopper PG porta
- ESA : Blindal 60 porta 1 ante / 60 porta 2 ante Blindal 70 porta 1 ante / 70 porta 2 ante
- FRESIA : Global 48 porta
- INDINVEST : Alpha 445 porta 2 ante
- METRA : NC 45 International porta NC 45 Superthermic porta NC 55 International porta NC 68 Superthermic porta / Nuovo NC 50 porta Superblindo
- NEW TEC : New Tec 50 porta complanare
- OCMA : SV 47 porta 1 ante / SV 47 porta 2 ante SV 62 porta 1 ante / SV 62 porta 2 ante SV 62 TT porta 1 ante / SV 62 TT porta 2 ante
- PASSERINI : Ekip Blindo Ekip Maastricht 53 porta 1 ante Ekip Maastricht 53 porta 2 ante Ekip Maastricht TH 60/68 porta 1 ante Ekip Maastricht TH 60/68 porta 2 ante Ekip Thermo 53 porta
- PROFILATI : PE "Eku 53" porta PE "Eku 64 TT" : porta PE "Eku 72 TT" : porta Sistema 1 PE 40 complanare /esterno 2 ante Sistema 1 PE 40 sormonto 2 ante
- SCHUCO : Royal 78 ST blindato Royal S 50 N Royal S 55 TT Royal S 65 TT
- WICONA : L60-A / L70A

**033175** D 1 1 10

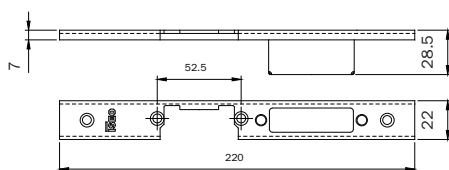

**LEFT- HAND** adjustable **DIN RIGHT**

**033176** C 1 1 10

**For locks for metal frames series 79\***



Code

Multiple package  
Single package  
Status

Min. ord.

**Multiblindo classic**



Full-size scale

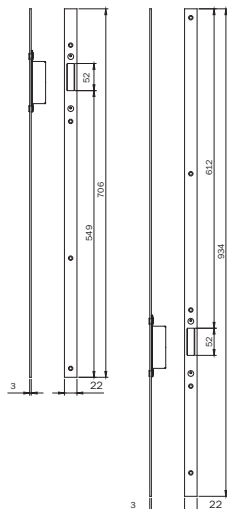

Pair of **ADJUSTABLE** closed striking plates for top/bottom **DEADBOLT DEVIATORS** MULTIBLINDO. Material: stainless steel. Flat front plate **1860x22x3**.

Can be used with central striking plates

033173-033174

- ALCAN** : Abithal Cristal / Abithal Keeper porta C.E. / Winner finestra
- ALCOA** : FB 12 GA / Europa GA / FB 12 TT / R 35 reversibile R 35 sormonto
- ALLCO** : All.Co 5 complanare / Export 40 finestra Export 45 TT finestra / Export 50 finestra / Export 50 TT finestra Final 40 finestra / Ites P4 complanare / Sicurbilin C.E.
- ALNOR** : Blindo Block / Montreal G.A.
- ALU-K** : N53 complanare / N 55 TT complanare
- ALU-MEC** : Synthesis 45 finestra / Synthesis 57 finestra Synthesis 60 TT finestra
- ALUSUISSE** : Aisec 2000 finestra 59 / Aisec 2000 finestra 69
- BODEGA** : BGA 50 / New BT 60
- DOMAL** : Domal Break 52 finestra / Domal Break 70 finestra Domal Stopper PG finestra
- EQUIPE** : Sistema 8000 G.A. finestra 1 anta Sistema 8000 G.A. finestra 2 ante / Sistema 8000 TT finestra 1 anta Sistema 8000 TT finestra 2 ante
- ESA** : Giuntall complanare / Giuntall porta / Isola porta
- ESEDRA** : GA 53 porta / TT 63 porta / TT 75 porta
- INDINVEST** : Alpha 255 complanare Alpha 370 TT complanare Alpha 445 finestra / Alpha 445 porta 1 anta Alpha 658 TT complanare / Alpha Blitz 2000 / Alpha Globo 45 Alpha Globo 55 / Gold 400 complanare / Gold 400 sormonto Gold 500 complanare / Gold 500 sormonto / Gold 600 complanare Gold 600 sormonto
- METRA** : NC 45 International finestra / NC 45 Superthermic finestra NC 55 International finestra / NC 68 Superthermic finestra Nuovo NC 40 complanare / Nuovo NC 40 sormonto 2 ante Nuovo NC 50 complanare
- MORELLI** : MA 8300
- OCMA** : FC 47 finestra / FC 55 finestra / FC 60 TT finestra
- PASSERINI** : Ekip 40 complanare 2 ante / Ekip 40 evoluzione 2 ante Ekip 40 sormonto 2 ante / Ekip 50 complanare 2 ante Ekip 50 sormonto 2 ante / Ekip Maastricht 53 finestra Ekip Maastricht TH 60 finestra / Ekip Maastricht TH 68 finestra Ekip Thermo 53 finestra 2 ante
- PROFILATI** : "PE Eku 53" finestra" / "PE Eku 64 TT" finestra" "PE Eku 72 TT" finestra" / Sistema 1 PE 50 comp./est. 2 ante Sistema 1 PE 50 sormonto 2 ante

**033177** D 1 10 10



Full-size scale

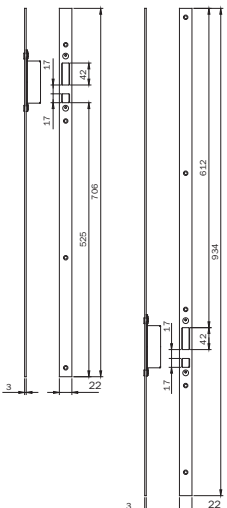

Pair of **ADJUSTABLE** closed striking plates for top/bottom **HOOK DEVIATORS** MULTIBLINDO. Material: stainless steel.

Flat front plate **1860x22x3**.

Can be used with central striking plates 033173-033174

- ALCAN** : Abithal Cristal / Abithal Keeper porta C.E. / Winner finestra
- ALCOA** : FB 12 GA / Europa GA / FB 12 TT / R 35 reversibile R 35 sormonto
- ALLCO** : All.Co 5 complanare / Export 40 finestra Export 45 TT finestra / Export 50 finestra / Export 50 TT finestra Final 40 finestra / Ites P4 complanare / Sicurbilin C.E.
- ALNOR** : Blindo Block / Montreal G.A.
- ALU-K** : N53 complanare / N 55 TT complanare
- ALU-MEC** : Synthesis 45 finestra / Synthesis 57 finestra Synthesis 60 TT finestra
- ALUSUISSE** : Aisec 2000 finestra 59 / Aisec 2000 finestra 69
- BODEGA** : BGA 50 / New BT 60
- DOMAL** : Domal Break 52 finestra / Domal Break 70 finestra Domal Stopper PG finestra
- EQUIPE** : Sistema 8000 G.A. finestra 1 anta Sistema 8000 G.A. finestra 2 ante / Sistema 8000 TT finestra 1 anta Sistema 8000 TT finestra 2 ante
- ESA** : Giuntall complanare / Giuntall porta / Isola porta
- ESEDRA** : GA 53 porta / TT 63 porta / TT 75 porta
- INDINVEST** : Alpha 255 complanare Alpha 370 TT complanare Alpha 445 finestra / Alpha 445 porta 1 anta Alpha 658 TT complanare / Alpha Blitz 2000 / Alpha Globo 45 Alpha Globo 55 / Gold 400 complanare / Gold 400 sormonto Gold 500 complanare / Gold 500 sormonto / Gold 600 complanare Gold 600 sormonto
- METRA** : NC 45 International finestra / NC 45 Superthermic finestra NC 55 International finestra / NC 68 Superthermic finestra Nuovo NC 40 complanare / Nuovo NC 40 sormonto 2 ante Nuovo NC 50 complanare
- MORELLI** : MA 8300
- OCMA** : FC 47 finestra / FC 55 finestra / FC 60 TT finestra
- PASSERINI** : Ekip 40 complanare 2 ante / Ekip 40 evoluzione 2 ante Ekip 40 sormonto 2 ante / Ekip 50 complanare 2 ante Ekip 50 sormonto 2 ante / Ekip Maastricht 53 finestra Ekip Maastricht TH 60 finestra / Ekip Maastricht TH 68 finestra Ekip Thermo 53 finestra 2 ante
- PROFILATI** : "PE Eku 53" finestra" / "PE Eku 64 TT" finestra" "PE Eku 72 TT" finestra" / Sistema 1 PE 50 comp./est. 2 ante Sistema 1 PE 50 sormonto 2 ante

**033178** D 1 10 10

**For locks for metal frames series 79\***



Code

Min. ord.  
Multiple package  
Single package  
Status

**Multiblindo classic**

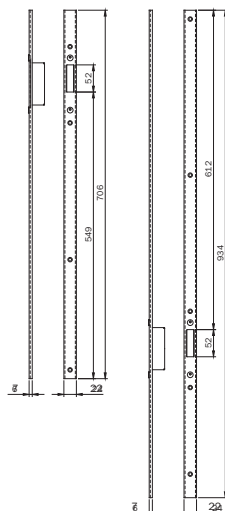
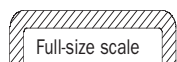

Pair of **ADJUSTABLE** closed striking plates for top/bottom **DEADBOLT DEVIATORS** MULTIBLINDO.  
Material: aluminium. U-front plate **1860x22x7**.  
Can be used with central striking plates  
033175-033176

- ALCAN** : Abithal Keeper porta 53-60 / 61-68  
Abithal porta / Winner orta
- ALCOA** : FB 12 Blindato porta  
Plana 1 anta / Plana 2 ante
- ALLCO** : All.co 5 porta / All.co 5 TT porta  
Export 50/50 TT porta / Sicurblin 65
- ALNOR** : Montreal porta
- ALUSUISSE** : Alsec 2000 porta 59 / Alsec 2000 porta 69
- ALLUK** : Alublindo / N 45 porta / N 53 porta / N 55 TT porta  
N 62 TT porta
- ALU-MEC** : Synthesis 57 porta / Synthesis 60TT porta
- BODEGA** : Extrablind 70
- DOMAL** : Domal Break 52 porta / Domal Break 70 porta  
Security porta / Shops porta / Stopper PG porta
- ESA** : Blindal 60 porta 1 anta / 60 porta 2 ante  
Blindal 70 porta 1 anta / 70 porta 2 ante
- FRESIA** : Global 48 porta
- INDINVEST** : Alpha 445 porta 2 ante
- METRA** : NC 45 International porta  
NC 45 Superthermic porta / NC 55 International porta  
NC 68 Superthermic porta / Nuovo NC 50 porta  
Superblindo
- NEW TEC** : New Tec 50 porta complanare
- OCMA** : SV 47 porta 1 anta / SV 47 porta 2 ante  
SV 62 porta 1 anta / SV 62 porta 2 ante  
SV 62 TT porta 1 anta / SV 62 TT porta 2 ante
- PASSERINI** : Ekip Blindo  
Ekip Maastricht 53 porta 1 anta  
Ekip Maastricht 53 porta 2 ante  
Ekip Maastricht TH 60/68 porta 1 anta  
Ekip Maastricht TH 60/68 porta 2 ante  
Ekip Thermo 53 porta
- PROFILATI** : PE "Eku 53" porta  
PE "Eku 64 TT" porta  
PE "Eku 72 TT" porta  
Sistema 1 PE 40 complanare / esterno 2 ante  
Sistema 1 PE 40 sormonto 2 ante
- SCHUCO** : Royal 78 ST blindato  
Royal S 50 N  
Royal S 55 TT  
Royal S 65 TT
- WICONA** : L60-A / L70-A

**033179** D 1 10 10

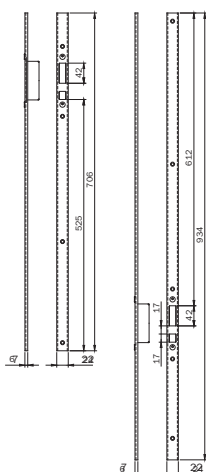
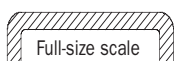

Pair of **ADJUSTABLE** closed striking plates for top/bottom **HOOK DEVIATORS** MULTIBLINDO.  
Material: aluminium. U-front plate **1860x22x7**.  
Can be used with central striking plates  
033175-033176

- ALCAN** : Abithal Keeper porta 53-60 / 61-68  
Abithal porta / Winner orta
- ALCOA** : FB 12 Blindato porta  
Plana 1 anta / Plana 2 ante
- ALLCO** : All.co 5 porta / All.co 5 TT porta  
Export 50/50 TT porta / Sicurblin 65
- ALNOR** : Montreal porta
- ALUSUISSE** : Alsec 2000 porta 59 / Alsec 2000 porta 69
- ALLUK** : Alublindo / N 45 porta / N 53 porta / N 55 TT porta  
N 62 TT porta
- ALU-MEC** : Synthesis 57 porta / Synthesis 60TT porta
- BODEGA** : Extrablind 70
- DOMAL** : Domal Break 52 porta / Domal Break 70 porta  
Security porta / Shops porta / Stopper PG porta
- ESA** : Blindal 60 porta 1 anta / 60 porta 2 ante  
Blindal 70 porta 1 anta / 70 porta 2 ante
- FRESIA** : Global 48 porta
- INDINVEST** : Alpha 445 porta 2 ante
- METRA** : NC 45 International porta  
NC 45 Superthermic porta / NC 55 International porta  
NC 68 Superthermic porta / Nuovo NC 50 porta  
Superblindo
- NEW TEC** : New Tec 50 porta complanare
- OCMA** : SV 47 porta 1 anta / SV 47 porta 2 ante  
SV 62 porta 1 anta / SV 62 porta 2 ante  
SV 62 TT porta 1 anta / SV 62 TT porta 2 ante
- PASSERINI** : Ekip Blindo  
Ekip Maastricht 53 porta 1 anta  
Ekip Maastricht 53 porta 2 ante  
Ekip Maastricht TH 60/68 porta 1 anta  
Ekip Maastricht TH 60/68 porta 2 ante  
Ekip Thermo 53 porta
- PROFILATI** : PE "Eku 53" porta  
PE "Eku 64 TT" porta  
PE "Eku 72 TT" porta  
Sistema 1 PE 40 complanare / esterno 2 ante  
Sistema 1 PE 40 sormonto 2 ante
- SCHUCO** : Royal 78 ST blindato  
Royal S 50 N  
Royal S 55 TT  
Royal S 65 TT
- WICONA** : L60-A / L70-A

**033180** D 1 10 10

**For locks for metal frames series 79\***



Code

Status  
Single package

Min. ord.

**Multiblindo classic**

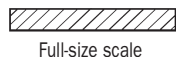

**ADJUSTABLE** closed striking plate

MULTIBLINDO. Material:

stainless steel. Flat front plate **180x22x3**.

Can be used with central striking plates 033173-033174

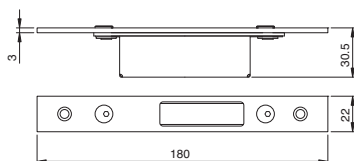

**DEADBOLT DEVIATORS**

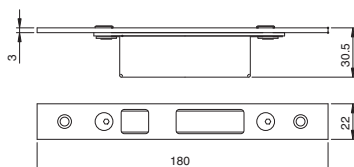

**HOOK DEVIATORS**



**ADJUSTABLE** closed striking plates for top/bottom

MULTIBLINDO. Material: aluminium.

U-front plate **180x22x7**. Can be used

with central striking plates 033175-033176.

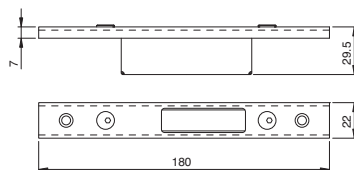

**DEADBOLT DEVIATORS**

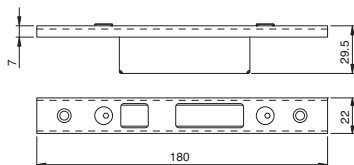

**HOOK DEVIATORS**

- ALCAN** : Abithal Cristal / Abithal Keeper porta C.E. / Winner finestra
- ALCOA** : FB 12 GA / Europa GA / FB 12 TT / R 35 reversibile R 35 sormonto
- ALLCO** : All.Co 5 complanare / Export 40 finestra
- Export 45 TT finestra / Export 50 finestra / Export 50 TT finestra
- Final 40 finestra / Ites P4 complanare / Scirubin C.E.
- ALNOR** : Blindo Block / Montreal G.A.
- ALU-K** : N53 complanare / N 55 TT complanare
- ALU-MEC** : Synthesis 45 finestra / Synthesis 57 finestra
- Synthesis 60 TT finestra
- ALUSUISSE** : Alsec 2000 finestra 59 / Alsec 2000 finestra 69
- BODEGA** : BGA 50 / New BT 60
- DOMAL** : Domal Break 52 finestra / Domal Break 70 finestra
- Domal Stopper PG finestra
- EQUIPE** : Sistema 8000 G.A. finestra 1 anta
- Sistema 8000 G.A. finestra 2 ante / Sistema 8000 TT finestra 1 anta
- Sistema 8000 TT finestra 2 ante
- ESA** : Giuntali complanare / Giuntali porta / Isola porta
- ESEDRA** : GA 53 porta / TT 63 porta / TT 75 porta
- INDINVEST** : Alpha 255 complanare
- Alpha 370 TT complanare
- Alpha 445 finestra / Alpha 445 porta 1 anta
- Alpha 658 TT complanare / Alpha Blitz 2000 / Alpha Globo 45
- Alpha Globo 55 / Gold 400 complanare / Gold 400 sormonto
- Gold 500 complanare / Gold 500 sormonto / Gold 600 complanare
- Gold 600 sormonto
- METRA** : NC 45 International finestra / NC 45 Superthermic finestra
- NC 55 International finestra / NC 68 Superthermic finestra
- Nuovo NC 40 complanare / Nuovo NC 40 sormonto 2 ante
- Nuovo NC 50 complanare
- MORELLI** : MA 8300
- OCMA** : FC 47 finestra / FC 55 finestra / FC 60 TT finestra
- PASSERINI** : Ekip 40 complanare 2 ante / Ekip 40 evoluzione 2 ante
- Ekip 40 sormonto 2 ante / Ekip 50 complanare 2 ante
- Ekip 50 sormonto 2 ante / Ekip Maastricht 53 finestra
- Ekip Maastricht TH 60 finestra / Ekip Maastricht TH 68 finestra
- Ekip Thermo 53 finestra 2 ante
- PROFILATI** : "PE" Eku 53 "finestra" / "PE" Eku 64 TT "finestra"
- "PE" Eku 72 TT "finestra" / Sistema 1 PE 50 comp./est. 2 ante
- Sistema 1 PE 50 sormonto 2 ante

**033181** D 1 10 10

**033182** D 1 10 10

- ALCAN** : Abithal Keeper porta 5360 / 61-68
- Abithal porta / Winner orta
- ALCOA** : FB 12 Blindato porta
- Plana 1 anta / Plana 2 ante
- ALLCO** : All.co 5 porta / All.co 5 TT porta
- Export 50/50 TT porta / Scirubin 65
- ALNOR** : Montreal porta
- ALUSUISSE** : Alsec 2000 porta 59 / Alsec 2000 porta 69
- ALU-K** : Alublindo / N 45 porta / N 53 porta / N 55 TT porta
- N 62 TT porta
- ALU-MEC** : Synthesis 57 porta / Synthesis 60TT porta
- BODEGA** : Extrablind 70
- DOMAL** : Domal Break 52 porta / Domal Break 70 porta
- Security porta / Shops porta / Stopper PG porta
- ESA** : Blindal 60 porta 1 anta / 60 porta 2 ante
- Blindal 70 porta 1 anta / 70 porta 2 ante
- FRESIA** : Global 48 porta
- INDINVEST** : Alpha 445 porta 2 ante
- METRA** : NC 45 International porta
- NC 45 Superthermic porta / NC 55 International porta
- NC 68 Superthermic porta / Nuovo NC 50 porta
- Superblindo
- NEW TEC** : New Tec 50 porta complanare
- OCMA** : SV 47 porta 1 anta / SV 47 porta 2 ante
- SV 62 porta 1 anta / SV 62 porta 2 ante
- SV 62 TT porta 1 anta / SV 62 TT porta 2 ante
- PASSERINI** : Ekip Blindo
- Ekip Maastricht 53 porta 1 anta
- Ekip Maastricht 53 porta 2 ante
- Ekip Maastricht TH 60/68 porta 1 anta
- Ekip Maastricht TH 60/68 porta 2 ante
- Ekip Thermo 53 porta
- PROFILATI** : "PE" Eku 53" porta
- PE "Eku 64 TT" porta
- PE "Eku 72 TT" porta
- Sistema 1 PE 40 complanare /esterno 2 ante
- Sistema 1 PE 40 sormonto 2 ante
- SCHUCO** : Royal 78 ST blindato
- Royal S 50 N
- Royal S 55 TT
- Royal S 65 TT
- WICONA** : L60A / L70A

**033183** D 1 10 10

**033184** B 1 10 10



**For locks for metal frames  
series 79\***



Code

Min. ord.  
Multiple  
package  
Single  
package  
Status

**Multiblindo classic**

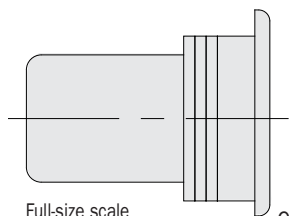

Full-size scale

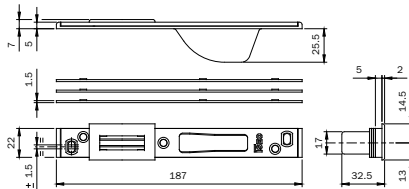

Closed striking plate for **CENTRAL LOCK**  
MULTIBLINDO. Material: stainless steel. Flat front plate  
**187x22x5**. With latchbolt guide and nylon roller.  
Spacers.

For series: 7951\* - 7955\* - 7971\* - 7991\* - 7911\*.

- ALCAN abithal Keeper Porta 53-60 / Abithal Keeper Porta 61-68  
Abithal Porta / Winner Porta
- ALCO alfo 12 Blindato / Formula F40 Porta / Formula F40 Tt Porta  
Formula F50 Porta / Formula F50 Tt Porta / Formula F60 Tt Porta  
Plana 1 Anta / Plana 2 Anta
- ALLCO all.Co 5 Porta / All.Co 5 Tt Porta / Export 50 Porta  
Export 50 Tt Porta / Sicurbin 65
- ALNOR montreal Porta / Alu-kalubindo / N 45 Porta / N 53 Porta  
N 55 Tt Porta / N 62 Tt Porta
- ALU-MEC synthesis 57 Porta / Synthesis 60 Tt Porta
- ALUSUISSE elsec 2000 Porta 59 / Alsec 2000 Porta 69
- BODEGA extrablind 70
- DOMAL domal Break 52 Porta / Domal Break 70 Porta  
Domal Security Porta / Domal Shops Porta  
Domal Stopper Pg Porta
- ESA Blindal 60 Porta 1 Anta / Blindal 60 Porta 2 Ante  
Blindal 70 Porta 1 Anta / Blindal 70 Porta 2 Ante
- FRESIA Global 48 Porta
- INDINVEST Alpha 445 Porta 2 Ante
- METRA Nc 45 International Porta / Nc 45 Superthermic Porta  
Nc 55 International Porta / Nc 68 Superthermic Porta  
Nuovo Nc 50 Porta / Superblindo
- NEW TEC new Tec 50 Porta Complanare  
New Tec 52 Tt Porta Complanare  
New Tec 68 Tt Porta Complanare
- OCMA fc 60 Tt Porta / Sv 47 Porta 1 Anta  
Sv 47 Porta 2 Ante  
Sv 62 Porta 1 Anta / Sv 62 Porta 2 Ante  
Sv 62 Tt Porta 1 Anta / Sv 62 Tt Porta 2 Ante
- PASSERINI Ekip Blindo / Ekip Maastricht 53 Porta 1 Anta  
Ekip Maastricht 53 Porta 2 Ante / Ekip Maastricht Th 60 Porta 1 Anta  
Ekip Maastricht Th 60 Porta 2 Ante  
Ekip Maastricht Th 68 Porta 1 Anta  
Ekip Maastricht Th 68 Porta 2 Ante / Ekip Thermo 53 Porta
- PROFILATI "Pe Eku 53 Porta" / "Pe Eku 64 Tt Porta"  
"Pe Eku 72 Tt Porta" / Sistema 1 Pe 40 Comp./Est. 2 Ante  
Sistema 1 Pe 40 Sormonto 2 Ante
- SCHÜCO royal 78 St Blindato / Royal S 50 N  
Royal S 55 Tt / Royal S 65 Tt
- WICONA 160A / L70A

**038079** A 10 - 10

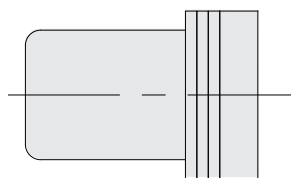

Full-size scale

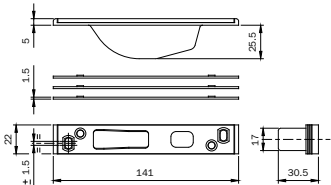

Closed striking plate for  
**HOOK DEVIATORS** MULTIBLINDO.  
Material: stainless steel. Flat front plate  
**141x22x5**. Spacers.

For series: 7955\* - 7991\*.

**038083** A 10 - 10

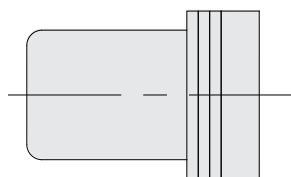

Full-size scale

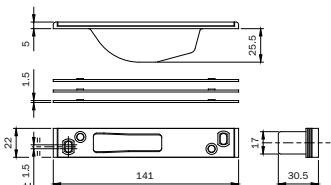

Closed striking plate for  
**DEADBOLT DEVIATORS** MULTIBLINDO.  
Material: stainless steel. Flat front plate **141x22x5**.  
Spacers. For series: 7951\* - 7991\*.

**038084** B 10 - 10

**For locks for metal frames  
series 79\***



Code

Min. ord.  
Multiple  
package  
Single  
package  
Status

**Multiblindo classic**

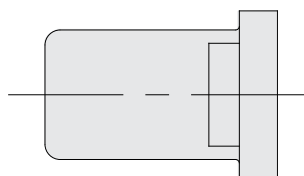

Full-size scale

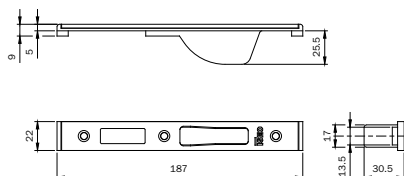

Closed striking plate for **CENTRAL LOCK**

MULTIBLINDO. Material: stainless steel.

Flat front plate **187x22x9**.

With latchbolt guide and nylon roller. Spacers.

For series: 7951\* - 7955\* - 7971\* - 7991\* - 7911\*.

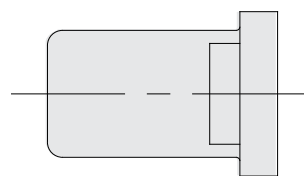

Full-size scale

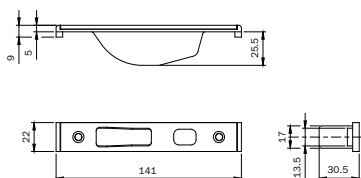

Closed striking plate for **HOOK DEVIATORS** MULTIBLINDO.

Material: stainless steel. Flat front plate **141x22x9**.

Spacers.

For series: 7955\* - 7991\*.

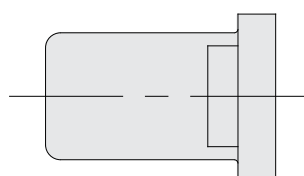

Full-size scale

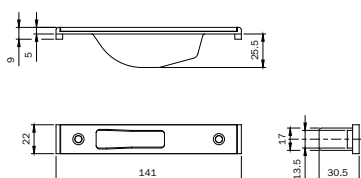

Closed striking plate for **DEADBOLT DEVIATORS**

MULTIBLINDO. Material: stainless steel. Flat front plate **141x22x9**.

Spacers. For series: 7951\* - 7991\*.

- ALCAN abithal Cristal / Abithal Keeper Porta C.E. / Winner Finestra
- ALCOA fb 12 Ga / Europa Ga / Fb 12 T.T.
- R 35 Reversibile / R 35 Sormonto
- ALLCO All.Co 5 Complanare / Export 40 Finestra
- Export 45 Tt Finestra / Export 50 Finestra
- Export 50 Tt Finestra / Final 40 Finestra / Ites P4 Complanare
- Sicurbilin C.E.
- ALNOR blindo Block / Montreal G.A.
- ALU-K n 53 Complanare / N 55 Tt Complanare
- ALU-MEC synthesis 45 Finestra / Synthesis 57 Finestra
- Synthesis 60 Tt Finestra
- ALUSUISSE aIsec 2000 Finestra 59 / AIsec 2000 Finestra 69
- BODEGA bga 50 / New Bt 60
- DOMAL Domal Break 52 Finestra / Domal Break 70 Finestra
- Domal Stopper Pg Finestra
- EQUIPE sistema 8000 G.A. Finestra 1 Anta
- Sistema 8000 G.A. Finestra 2 Ante
- Sistema 8000 Tt Finestra 1 Anta
- Sistema 8000 Tt Finestra 2 Ante
- ESA giuntall Complanare / Giuntall Porta / Isola Porta
- ESEDRA ga 53 Porta / Tt 63 Porta / Tt 75 Porta
- INDINVEST alpha 255 Complanare
- Alpha 370 Tt Complanare
- Alpha 445 Finestra / Alpha 445 Porta 1 Anta
- Alpha 658 Tt Complanare / Alpha Blitz 2000 / Alpha Globo 45
- Alpha Globo 55 / Gold 400 Complanare / Gold 400 Sormonto
- Gold 500 Complanare / Gold 500 Sormonto
- Gold 600 Complanare Gold 600 Sormonto
- METRA nc 45 International Finestra
- Nc 45 Superthermic Finestra / Nc 55 International Finestra
- Nc 68 Superthermic Finestra / Nuovo Nc 40 Complanare
- Nuovo Nc 40 Sormonto 2 Ante / Nuovo Nc 50 Complanare
- MORELLI ma 8300
- OCMA fc 47 Finestra / Fc 55 Finestra / Fc 60 Tt Finestra
- PASSERINI ekip 40 Complanare 2 Ante
- Ekip 40 Evoluzione 2 Ante
- Ekip 40 Sormonto 2 Ante / Ekip 50 Complanare 2 Ante
- Ekip 50 Sormonto 2 Ante / Ekip Maastricht 53 Finestra
- Ekip Maastricht Th 60 Finestra
- Ekip Maastricht Th 68 Finestra
- Ekip Thermo 53 Finestra 2 Ante
- PROFILATI \*Pe Eku 53 Finestra\*
- \*Pe Eku 64 Tt Finestra\*
- \*Pe Eku 72 Tt Finestra\*
- Sistema 1 Pe 50 Comp./Est. 2 Ante
- Sistema 1 Pe 50 Sormonto 2 Ante

**038085** B 10 - 10

**038086** B 10 - 10

**038087** D 10 - 10

**For locks for metal frames  
series 79\***



Code

Status  
Single  
package  
Multiple  
package  
Min. ord.

**Multiblindo classic**

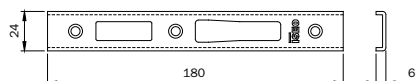
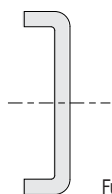

Striking plate for **CENTRAL LOCK** MULTIBLINDO.  
Material: stainless steel. Flat front plate **180x24x3**.  
For series: 7951\* - 7955\* - 7971\* - 7991\* - 7911\*.

**038088** B 10 - 10

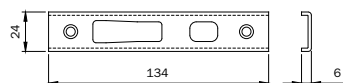
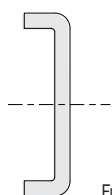

Striking plate for **HOOK DEVIATORS** MULTIBLINDO.  
Material: stainless steel. Flat front plate **134x24x6**.  
For series: 7955\* - 7991\*.

**038089** B 10 - 10

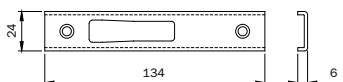
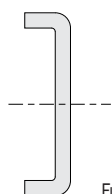

Striking plate for **DEADBOLT DEVIATORS** MULTIBLINDO.  
Material: stainless steel. Flat front plate **134x24x6**.  
For series: 7951\* - 7991\*.

**038090** B 10 - 10

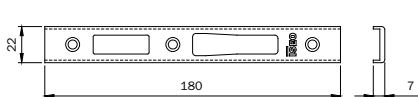
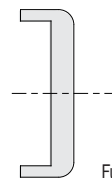

Striking plate for **CENTRAL LOCK** MULTIBLINDO.  
Material: black painted stainless steel. Flat front plate **180x22x7**.  
For series: 7951\* - 7955\* - 7971\* - 7991 - 7911\*.

**038091** C 10 - 10

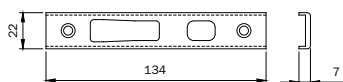
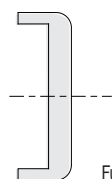

Striking plate for **HOOK DEVIATORS** MULTIBLINDO.  
Material: black painted stainless steel. Flat front plate **134x22x7**.  
For series: 7955\* - 7991\*.

**038092** C 10 - 10

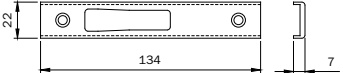
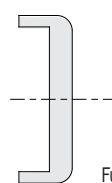

Striking plate for **DEADBOLT DEVIATORS** MULTIBLINDO.  
Material: black painted stainless steel. Flat front plate **134x22x7**.  
For series: 7951\* - 7991\*.

**038093** C 10 - 10



Pair of NYLON front plate **SUPPORTS 22x8** for locks  
for aluminium frames with European profile cylinder and  
double-bit rail frames  
For series: 78\* - 96\* - 98\*.

**038019** B 10 - 10









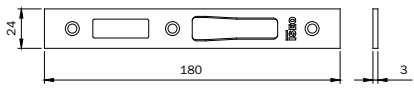

**For locks for metal frames series 79\***

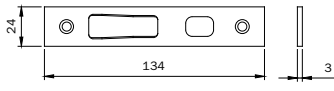

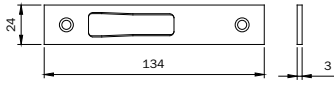
Code

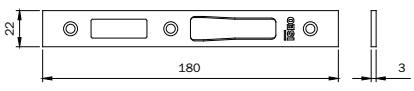
Min. ord.  
Multiple package  
Single package  
Status

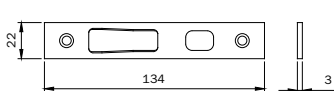
**Multiblindo classic**

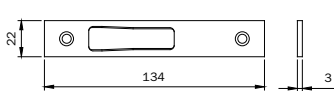
 <p>Full-size scale</p>	 <p>Striking plate for <b>CENTRAL LOCK</b> MULTIBLINDO. Material: stainless steel. Flat front plate <b>180x24x3</b>. For series: 7951* - 7955* - 7971* - 7991* - 7911*.</p>	<p><b>038094</b> A 10 - 10</p>
 <p>Full-size scale</p>	 <p>Striking plate for <b>HOOK DEVIATORS</b> MULTIBLINDO. Material: stainless steel. Flat front plate <b>134x24x3</b>. For series: 7955* - 7991*.</p>	<p><b>038095</b> A 10 - 10</p>
 <p>Full-size scale</p>	 <p>Striking plate for <b>DEADBOLT DEVIATORS</b> MULTIBLINDO. Material: stainless steel. Flat front plate <b>134x24x3</b>. For series: 7951* - 7991*.</p>	<p><b>038096</b> A 10 - 10</p>
 <p>Full-size scale</p>	 <p>Striking plate for <b>CENTRAL LOCK</b> MULTIBLINDO. Material: stainless steel. Flat front plate <b>180x22x3</b>. For series: 7951* - 7955* - 7971* - 7991 - 7911*.</p>	<p><b>038097</b> C 10 - 10</p>
 <p>Full-size scale</p>	 <p>Striking plate for <b>HOOK DEVIATORS</b> MULTIBLINDO. Material: stainless steel. Flat front plate <b>134x22x3</b>. For series: 7955* - 7991*.</p>	<p><b>038098</b> C 10 - 10</p>
 <p>Full-size scale</p>	 <p>Striking plate for <b>DEADBOLT DEVIATORS</b> MULTIBLINDO. Material: stainless steel. Flat front plate <b>134x22x3</b>. For series: 7951* - 7991*.</p>	<p><b>038099</b> B 10 - 10</p>



ADJUSTABLE MECHANICAL STRIKER for use with central striking plate MULTIBLINDO series 033160-033161-033162-033163-033173-033174-033175-033176.

**040890** B 1 10 10

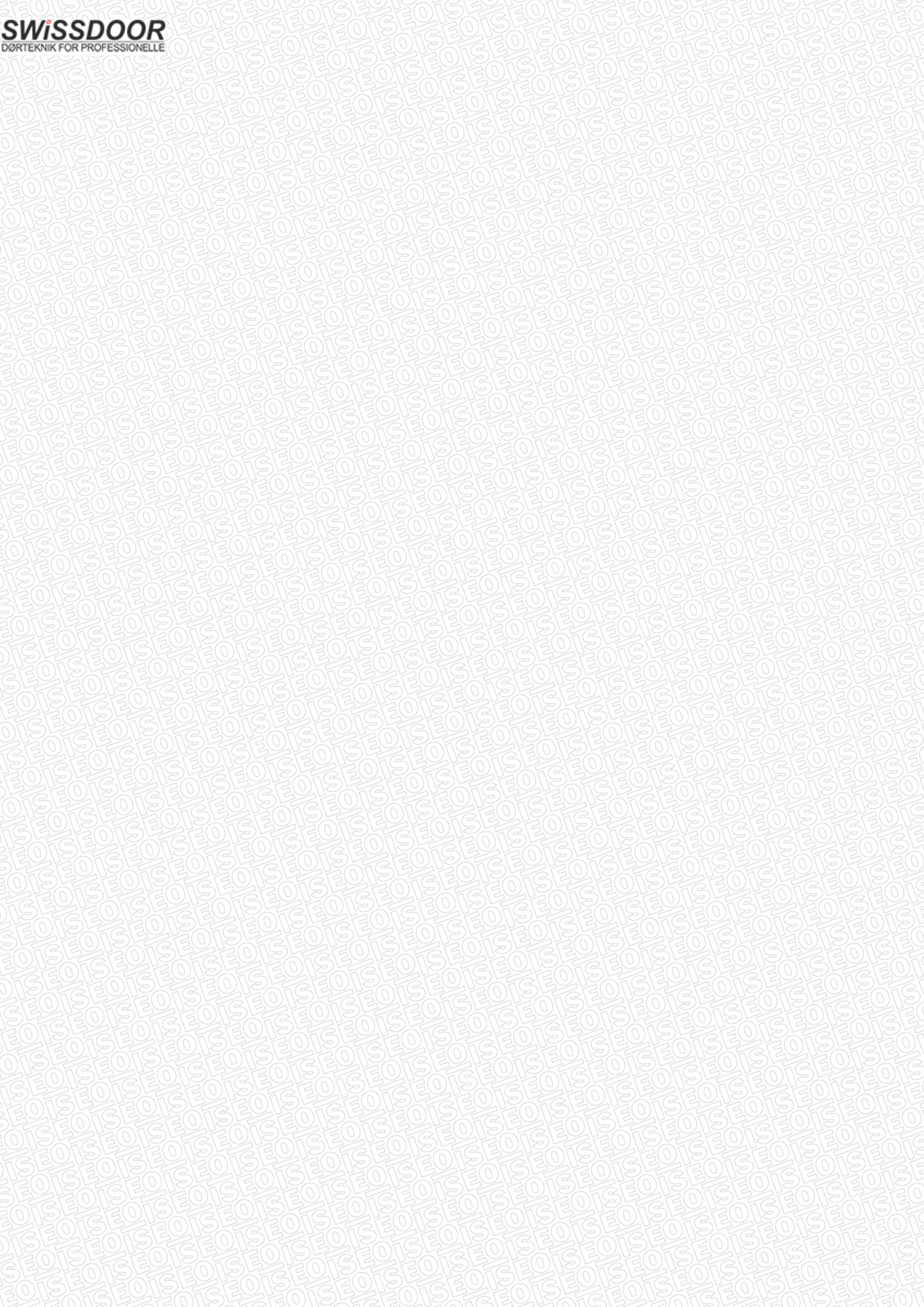



**Locks for  
metal frames**



Code

Min. ord.  
Multiple  
package  
Single  
package  
Status

**Electa multipoint electric lock**

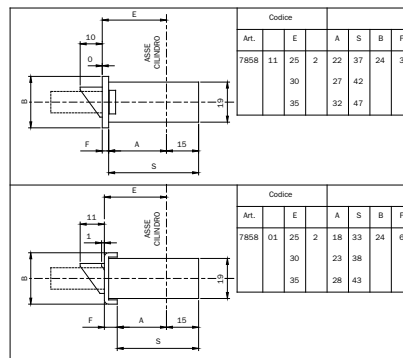
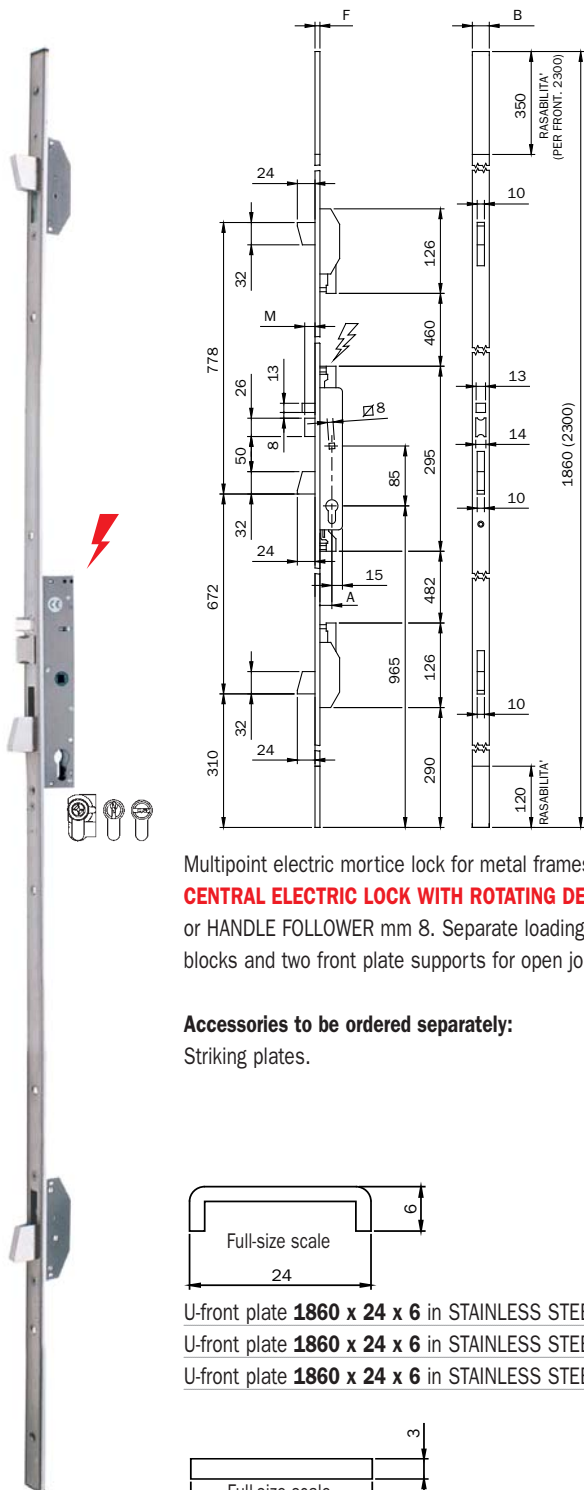

Multipoint electric mortice lock for metal frames with 3 LATERAL LOCKINGS, **12V A.C.-D.C.**, operating with European profile cylinder **CENTRAL ELECTRIC LOCK WITH ROTATING DEADBOLT** and mm 24 throw. **SELF-LOCKING LATCHBOLT**. Latchlocking by electric pulse, key or HANDLE FOLLOWER mm 8. Separate loading spring. Adjustable bottom. 2 deviators, with rotating deadbolt mm 24 throw. 2 nylon end blocks and two front plate supports for open joint for U-version. 2 cylinder escutcheons. Fixing screws. Instruction sheet.

**Accessories to be ordered separately:**

Striking plates.

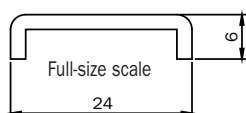

U-front plate <b>1860 x 24 x 6</b> in STAINLESS STEEL. Backset mm 25	<b>785801252</b>	D	1	-	1
U-front plate <b>1860 x 24 x 6</b> in STAINLESS STEEL. Backset mm 30	<b>785801302</b>	D	1	-	1
U-front plate <b>1860 x 24 x 6</b> in STAINLESS STEEL. Backset mm 35	<b>785801352</b>	C	1	-	1

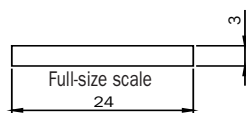

Flat front plate <b>1860 x 24 x 3</b> in STAINLESS STEEL. Backset mm 25	<b>785811252</b>	D	1	-	1
Flat front plate <b>1860 x 24 x 3</b> in STAINLESS STEEL. Backset mm 30	<b>785811302</b>	C	1	-	1
Flat front plate <b>1860 x 24 x 3</b> in STAINLESS STEEL. Backset mm 35	<b>785811352</b>	C	1	-	1



Code

Min. ord.  
Multiple  
package  
Single  
package  
Status

**Electa multipoint electric lock**

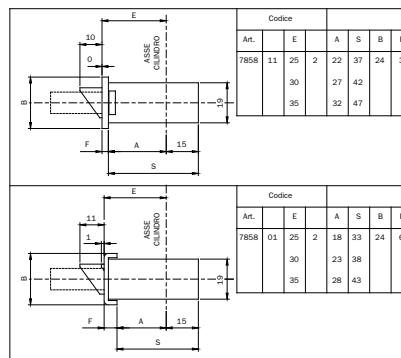
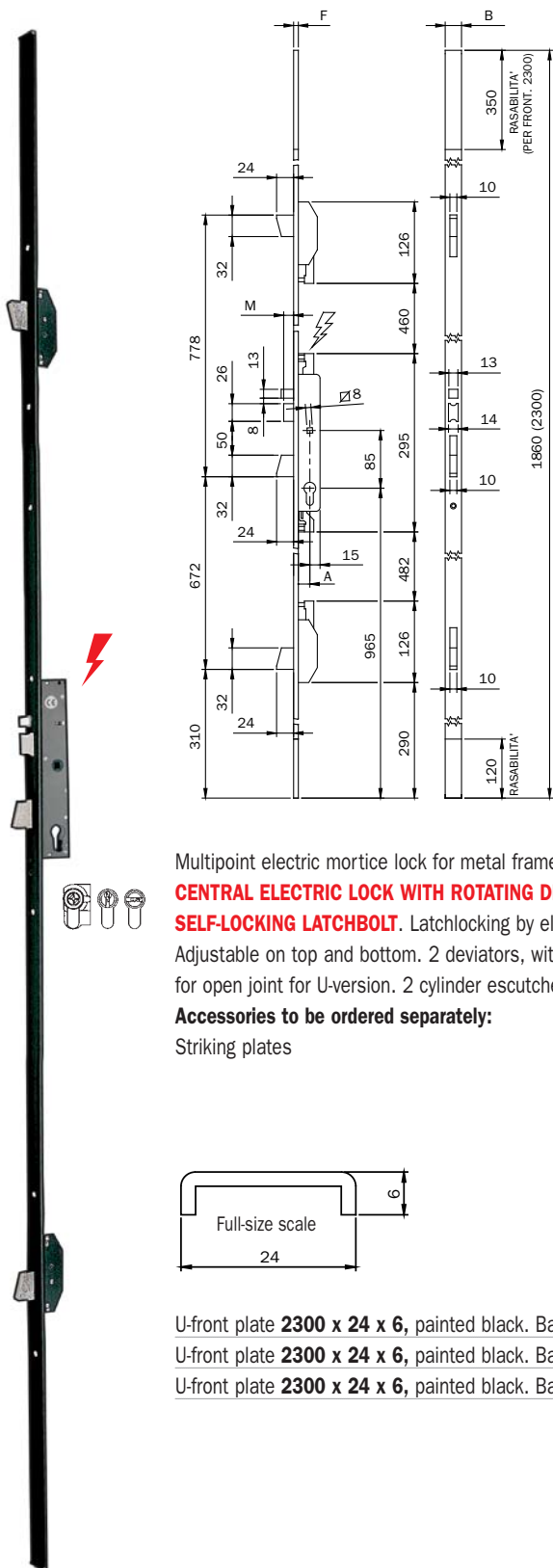

Multipoint electric mortice lock for metal frames with 3 LATERAL LOCKINGS, **12V A.C.-D.C.**, operating with European profile cylinder **CENTRAL ELECTRIC LOCK WITH ROTATING DEADBOLT** and mm 24 throw.

**SELF-LOCKING LATCHBOLT**. Latching by electric pulse, key or HANDLE FOLLOWER mm 8. Separate loading spring.

Adjustable on top and bottom. 2 deviators, with rotating deadbolt mm 24 throw. 2 nylon end blocks and two front plate supports for open joint for U-version. 2 cylinder escutcheons. Fixing screws. Instruction sheet.

**Accessories to be ordered separately:**

Striking plates

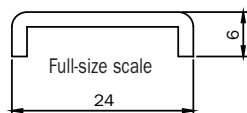

U-front plate <b>2300 x 24 x 6</b> , painted black. Backset mm 25	<b>785800250</b>	C	1	-	1
U-front plate <b>2300 x 24 x 6</b> , painted black. Backset mm 30	<b>785800300</b>	B	1	-	1
U-front plate <b>2300 x 24 x 6</b> , painted black. Backset mm 35	<b>785800350</b>	B	1	-	1





Code

Status  
Single  
package

Min. ord.

**Electa** multipoint electric lock

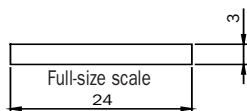

Flat front plate <b>2300 x 24 x 3</b> , painted black steel. Backset mm 25	<b>785810250</b>	D	1	-	1
Flat front plate <b>2300 x 24 x 3</b> , painted black steel. Backset mm 30	<b>785810300</b>	B	1	-	1
Flat front plate <b>2300 x 24 x 3</b> , painted black steel. Backset mm 35	<b>785810350</b>	B	1	-	1

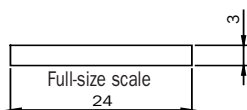

**Long latchbolt and piston + mm5**

Flat front plate <b>2300 x 24 x 3</b> , painted black steel. Backset mm 25	<b>7858102505</b>	D	1	-	1
Flat front plate <b>2300 x 24 x 3</b> , painted black steel. Backset mm 30	<b>7858103005</b>	D	1	-	1
Flat front plate <b>2300 x 24 x 3</b> , painted black steel. Backset mm 35	<b>7858103505</b>	D	1	-	1



Code

Min. ord.  
Multiple package  
Single package  
Status

**Electa multipoint lock**

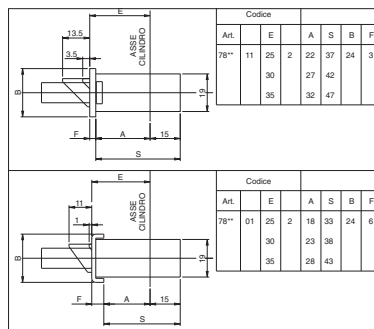
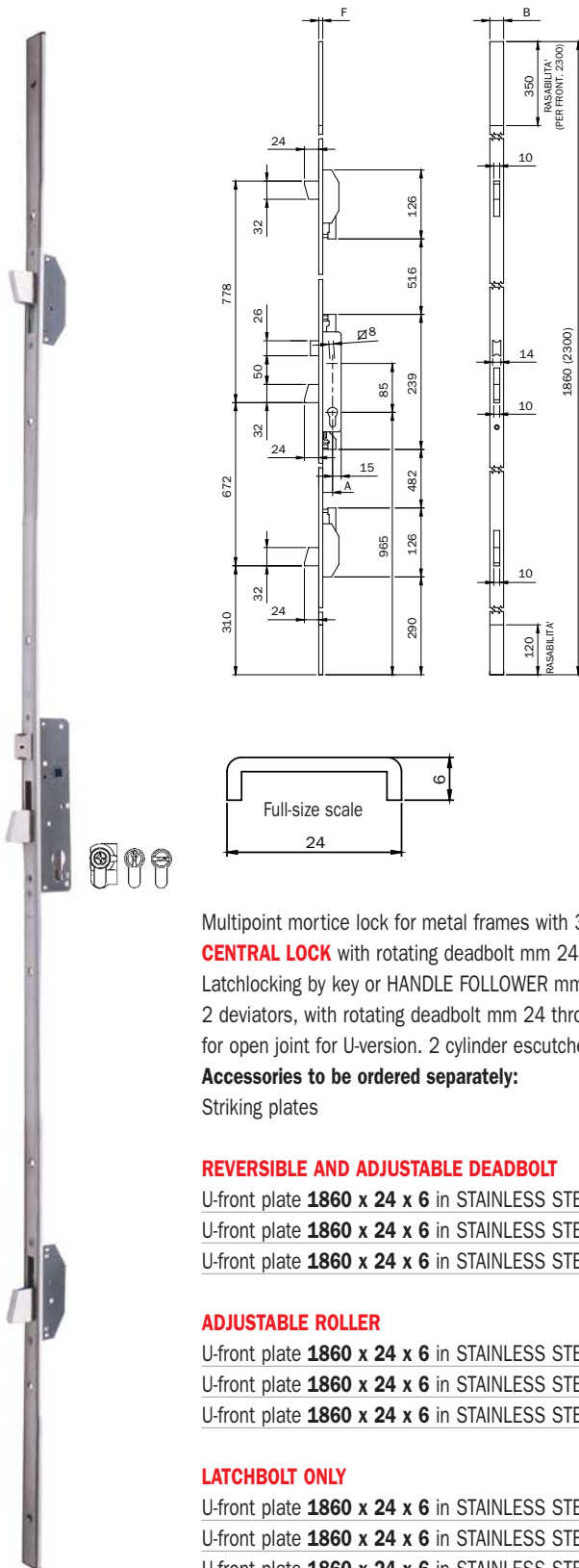

Codice							
Art.	E	A	S	B	F		
78**	11	25	2	22	37	24	3
	30			27	42		
	35			32	47		

Codice							
Art.	E	A	S	B	F		
78**	01	25	2	18	33	24	6
	30			23	38		
	35			28	43		

Multipoint mortice lock for metal frames with 3 LATERAL LOCKINGS, operating with European profile cylinder

**CENTRAL LOCK** with rotating deadbolt mm 24 throw.

Latching by key or HANDLE FOLLOWER mm 8.

2 deviators, with rotating deadbolt mm 24 throw. Adjustable bottom. 2 nylon end blocks and two front plate supports for open joint for U-version. 2 cylinder escutcheons. Fixing screws. Instruction sheet.

**Accessories to be ordered separately:**

Striking plates

**REVERSIBLE AND ADJUSTABLE DEADBOLT**

U-front plate <b>1860 x 24 x 6</b> in STAINLESS STEEL. Backset mm 25	<b>785101252</b>	A	1	-	1
U-front plate <b>1860 x 24 x 6</b> in STAINLESS STEEL. Backset mm 30	<b>785101302</b>	A	1	-	1
U-front plate <b>1860 x 24 x 6</b> in STAINLESS STEEL. Backset mm 35	<b>785101352</b>	A	1	-	1

**ADJUSTABLE ROLLER**

U-front plate <b>1860 x 24 x 6</b> in STAINLESS STEEL. Backset mm 25	<b>785201252</b>	D	1	-	1
U-front plate <b>1860 x 24 x 6</b> in STAINLESS STEEL. Backset mm 30	<b>785201302</b>	B	1	-	1
U-front plate <b>1860 x 24 x 6</b> in STAINLESS STEEL. Backset mm 35	<b>785201352</b>	B	1	-	1

**LATCHBOLT ONLY**

U-front plate <b>1860 x 24 x 6</b> in STAINLESS STEEL. Backset mm 25	<b>785301252</b>	C	1	-	1
U-front plate <b>1860 x 24 x 6</b> in STAINLESS STEEL. Backset mm 30	<b>785301302</b>	D	1	-	1
U-front plate <b>1860 x 24 x 6</b> in STAINLESS STEEL. Backset mm 35	<b>785301352</b>	D	1	-	1



Code

Min. ord.  
Multiple  
package  
Single  
package  
Status

**Electa multipoint lock**

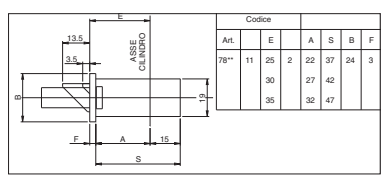
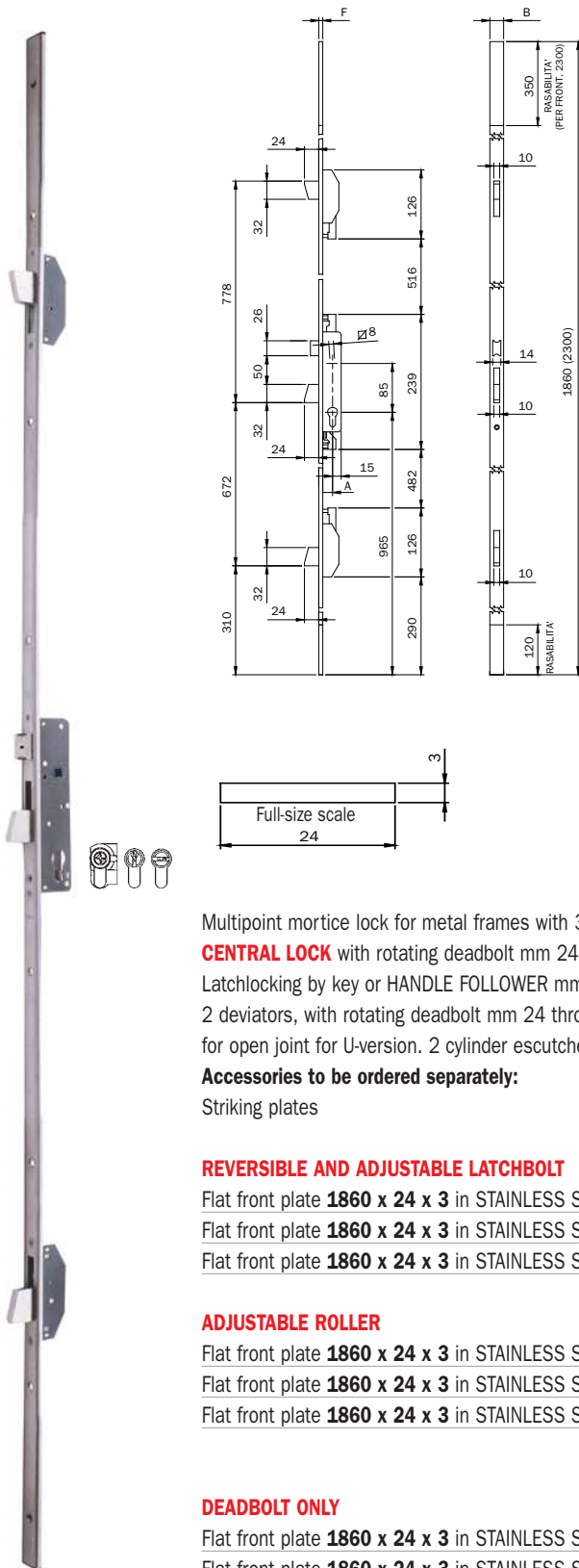

Codice					
Art.	E	A	S	B	F
78**	11	25	2	22	37
	30		27	42	24
	35		32	47	3

Multipoint mortice lock for metal frames with 3 LATERAL LOCKINGS, operating with European profile cylinder

**CENTRAL LOCK** with rotating deadbolt mm 24 throw.

Latching by key or HANDLE FOLLOWER mm 8.

2 deviators, with rotating deadbolt mm 24 throw. Adjustable bottom. 2 nylon end blocks and two front plate supports for open joint for U-version. 2 cylinder escutcheons. Fixing screws. Instruction sheet.

**Accessories to be ordered separately:**

Striking plates

**REVERSIBLE AND ADJUSTABLE LATCHBOLT**

Flat front plate <b>1860 x 24 x 3</b> in STAINLESS STEEL. Backset mm 25	<b>785111252</b>	A	1	-	1
Flat front plate <b>1860 x 24 x 3</b> in STAINLESS STEEL. Backset mm 30	<b>785111302</b>	A	1	-	1
Flat front plate <b>1860 x 24 x 3</b> in STAINLESS STEEL. Backset mm 35	<b>785111352</b>	A	1	-	1

**ADJUSTABLE ROLLER**

Flat front plate <b>1860 x 24 x 3</b> in STAINLESS STEEL. Backset mm 25	<b>785211252</b>	D	1	-	1
Flat front plate <b>1860 x 24 x 3</b> in STAINLESS STEEL. Backset mm 30	<b>785211302</b>	B	1	-	1
Flat front plate <b>1860 x 24 x 3</b> in STAINLESS STEEL. Backset mm 35	<b>785211352</b>	B	1	-	1

**DEADBOLT ONLY**

Flat front plate <b>1860 x 24 x 3</b> in STAINLESS STEEL. Backset mm 25	<b>785311252</b>	C	1	-	1
Flat front plate <b>1860 x 24 x 3</b> in STAINLESS STEEL. Backset mm 30	<b>785311302</b>	D	1	-	1
Flat front plate <b>1860 x 24 x 3</b> in STAINLESS STEEL. Backset mm 35	<b>785311352</b>	D	1	-	1



Code

Min. ord.  
Multiple  
package  
Single  
package  
Status

**Electa multipoint lock**

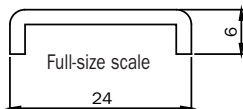
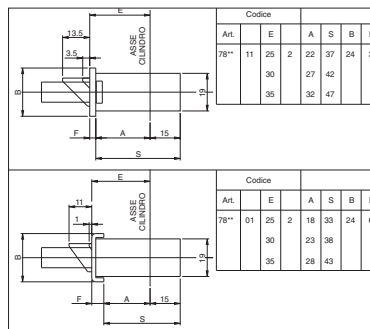
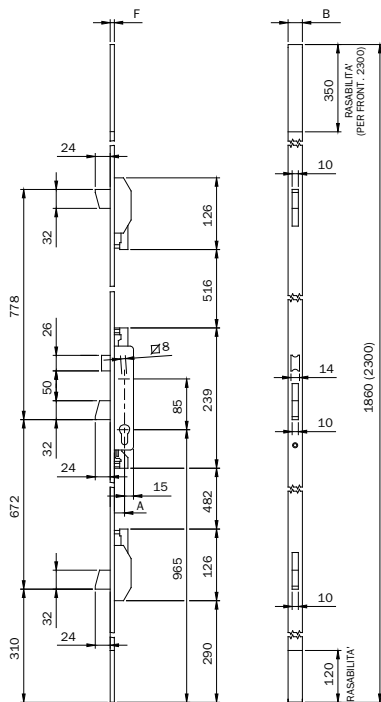

Multipoint mortice lock for metal frames with 3 LATERAL LOCKINGS, operating with European profile cylinder

**CENTRAL LOCK** with rotating deadbolt mm 24.

Latching by key or handle follower mm 8. 2 deviators, with rotating deadbolt mm 24 throw.

Adjustable top and bottom. 2 nylon end blocks. 2 front plate supports for open joint.

2 cylinder escutcheons. Fixing screws. Instruction sheet.

**Accessories to be ordered separately:**

Striking plates.

**REVERSIBLE AND ADJUSTABLE LATCHBOLT**

U-front plate <b>2300 x 24 x 6</b> in black painted steel. Backset mm 25	<b>785100250</b>	A	1	-	1
U-front plate <b>2300 x 24 x 6</b> in black painted steel. Backset mm 30	<b>785100300</b>	A	1	-	1
U-front plate <b>2300 x 24 x 6</b> in black painted steel. Backset mm 35	<b>785100350</b>	A	1	-	1

**ADJUSTABLE ROLLER**

U-front plate <b>2300 x 24 x 6</b> in black painted steel. Backset mm 25	<b>785200250</b>	B	1	-	1
U-front plate <b>2300 x 24 x 6</b> in black painted steel. Backset mm 30	<b>785200300</b>	B	1	-	1
U-front plate <b>2300 x 24 x 6</b> in black painted steel. Backset mm 35	<b>785200350</b>	B	1	-	1

**DEADBOLT ONLY**

U-front plate <b>2300 x 24 x 6</b> in black painted steel. Backset mm 25	<b>785300250</b>	A	1	-	1
U-front plate <b>2300 x 24 x 6</b> in black painted steel. Backset mm 30/783	<b>785300300</b>	B	1	-	1
U-front plate <b>2300 x 24 x 6</b> in black painted steel. Backset mm 35	<b>785300350</b>	C	1	-	1



Code

Min. ord.  
Multiple  
package  
Single  
package  
Status

**Electa multipoint lock**

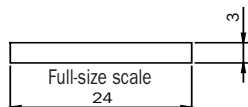
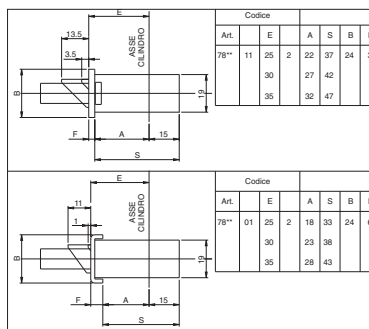
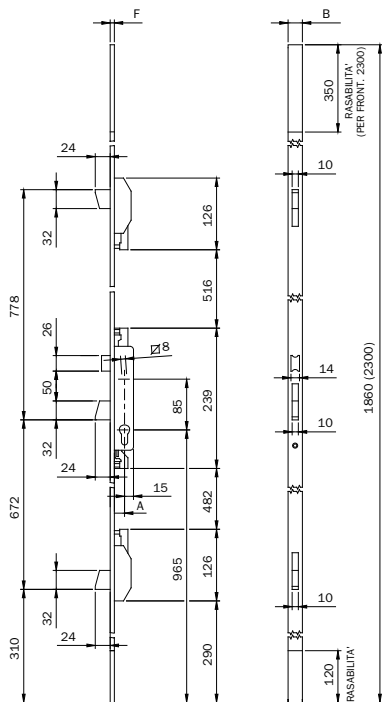

Multipoint mortice lock for metal frames with 3 LATERAL LOCKINGS, operating with European profile cylinder

**CENTRAL LOCK** with rotating deadbolt mm 24

Latching by key or handle follower mm 8. 2 deviators, with rotating deadbolt mm 24 throw.

Adjustable top and bottom. 2 cylinder escutcheons. Fixing screws. Instruction sheet.

**Accessories to be ordered separately:**

Striking plates.

**REVERSIBLE AND ADJUSTABLE LATCHBOLT**

Flat front plate <b>2300 x 24 x 3</b> in black painted steel. Backset mm 25	<b>785110250</b>	C	1	-	1
Flat front plate <b>2300 x 24 x 3</b> in black painted steel. Backset mm 30	<b>785110300</b>	A	1	-	1
Flat front plate <b>2300 x 24 x 3</b> in black painted steel. Backset mm 35	<b>785110350</b>	A	1	-	1

**ADJUSTABLE ROLLER**

Flat front plate <b>2300 x 24 x 3</b> in black painted steel. Backset mm 25	<b>785210250</b>	D	1	-	1
Flat front plate <b>2300 x 24 x 3</b> in black painted steel. Backset mm 30	<b>785210300</b>	B	1	-	1
Flat front plate <b>2300 x 24 x 3</b> in black painted steel. Backset mm 35	<b>785210350</b>	B	1	-	1

**DEADBOLT ONLY**

Flat front plate <b>2300 x 24 x 3</b> in black painted steel. Backset mm 25	<b>785310250</b>	D	1	-	1
Flat front plate <b>2300 x 24 x 3</b> in black painted steel. Backset mm 30	<b>785310300</b>	D	1	-	1
Flat front plate <b>2300 x 24 x 3</b> in black painted steel. Backset mm 35	<b>785310350</b>	D	1	-	1



Code

Min. ord.  
Multiple package  
Single package  
Status

**Electa multipoint lock**

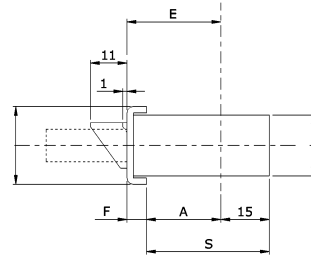
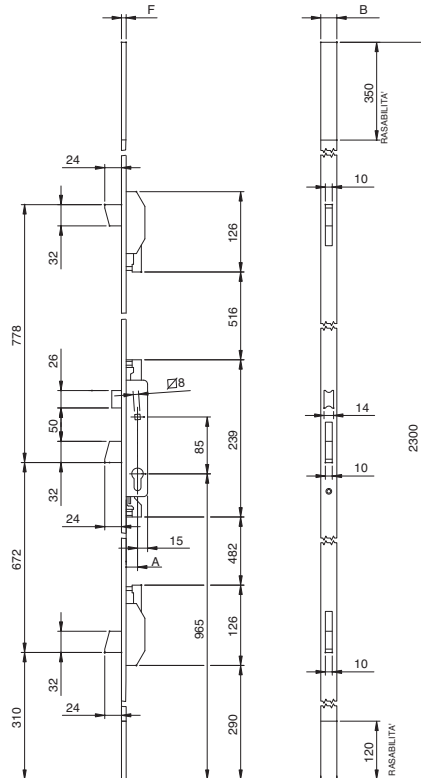

Codice					
Art.	E	A	S	B	F
78**	30	25	19	34	24
		30	24	39	
		35	29	44	

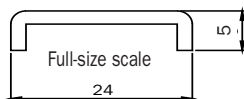

Multipoint mortice lock for metal frames with 3 LATERAL LOCKINGS, operating with European profile cylinder

**CENTRAL LOCK** with rotating deadbolt mm 24.

Latching by key or handle follower mm 8. Adjustable bottom. 2 deviators, with rotating deadbolt mm 24 throw.

Fixing screws. Instruction sheet.

**Accessories to be ordered separately:**

Striking plates.

**REVERSIBLE AND ADJUSTABLE LATCHBOLT**

U-front plate <b>2300 x 24 x 5</b> in STAINLESS STEEL. Backset mm 25	<b>785130252</b>	C	1	-	1
U-front plate <b>2300 x 24 x 5</b> in STAINLESS STEEL. Backset mm 30	<b>785130302</b>	D	1	-	1
U-front plate <b>2300 x 24 x 5</b> in STAINLESS STEEL. Backset mm 35	<b>785130352</b>	B	1	-	1

**ADJUSTABLE ROLLER**

U-front plate <b>2300 x 24 x 5</b> in STAINLESS STEEL. Backset mm 25	<b>785230252</b>	D	1	-	1
U-front plate <b>2300 x 24 x 5</b> in STAINLESS STEEL. Backset mm 30	<b>785230302</b>	D	1	-	1
U-front plate <b>2300 x 24 x 5</b> in STAINLESS STEEL. Backset mm 35	<b>785230352</b>	C	1	-	1

**DEADBOLT ONLY**

U-front plate <b>2300 x 24 x 5</b> in STAINLESS STEEL. Backset mm 25	<b>785330252</b>	D	1	-	1
U-front plate <b>2300 x 24 x 5</b> in STAINLESS STEEL. Backset mm 30	<b>785330302</b>	D	1	-	1
U-front plate <b>2300 x 24 x 5</b> in STAINLESS STEEL. Backset mm 35	<b>785330352</b>	D	1	-	1



Code

Min. ord.  
Multiple  
package  
Single  
package  
Status

**Electa electric lock stainless steel front plate mm 22**

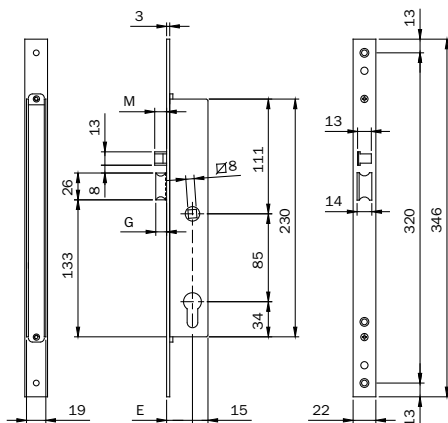

Electric mortice lock for metal frames, LATERAL LOCKING, **12V A.C.-D.C.**, operating with European profile cylinder.  
Front plate mm **346 x 22 x 3** in STAINLESS STEEL. **SELF-LOCKING LATCHBOLT ONLY**. Latchlocking by electric pulse,  
key or handle follower mm 8. Separate loading spring, 2 escutcheons. Pair of front plate spacers.  
Fixing screws. Instruction sheet.

**Accessories to be ordered separately:**

Striking plates

Backset mm 25	<b>781702252</b>	B	1	10	10
Backset mm 30	<b>781702302</b>	B	1	10	10
Backset mm 35	<b>781702352</b>	B	1	10	10

Electric mortice lock for metal frames, lateral locking, **12V A.C.-D.C.**, operating with European profile cylinder.  
Front plate mm **346 x 22 x 3** in STAINLESS STEEL. **SELF-LOCKING AND MM 5** extended latchbolt only. Latchlocking by electric pulse,  
key or handle follower mm 8. Separate mm 5 extended loading spring, 2 escutcheons. Pair of front plate spacers.  
Fixing screws. Instruction sheet.

**Accessories to be ordered separately:**

Striking plates

Backset mm 25	<b>781702252S</b>	D	1	10	10
Backset mm 30	<b>781702302S</b>	D	1	10	10
Backset mm 35	<b>781702352S</b>	D	1	10	10

Electric mortice lock for metal frames, LATERAL LOCKING, **24V A.C.-D.C.**, operating with European profile cylinder.  
Front plate mm **346 x 22 x 3** in STAINLESS STEEL. **SELF-LOCKING LATCHBOLT ONLY**. Latchlocking by electric pulse,  
key or handle follower mm 8. Separate loading spring, extended + mm 5. 2 escutcheons. Pair of front plate spacers.  
Fixing screws. Instruction sheet.

**Accessories to be ordered separately:**

Striking plates

Backset mm 25	<b>781702252V</b>	D	1	10	10
Backset mm 30	<b>781702302V</b>	D	1	10	10
Backset mm 35	<b>781702352V</b>	D	1	10	10



Code

Min. ord.  
Multiple  
package  
Single  
package  
Status

## Electa electric lock stainless steel front plate mm 22

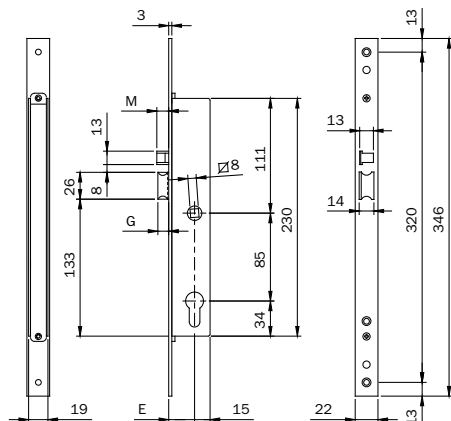

Electric mortice lock for metal frames, LATERAL LOCKING, **12V A.C.-D.C.**, operating with European profile cylinder  
Front plate mm **346 x 22 x 3** in STAINLESS STEEL. Rotating DEADBOLT 24 mm throw. Self-locking latchbolt only.  
Latchlocking by electric pulse, key or handle follower mm 8. Separate loading spring. 2 escutcheons. Pair of front plate spacers.  
Fixing screws. Instruction sheet.

**Accessories to be ordered separately:** Striking plates

Backset mm 25	<b>781802252</b>	A	1	10	10
Backset mm 30	<b>781802302</b>	A	1	10	10
Backset mm 35	<b>781802352</b>	A	1	10	10



Electric mortice lock for metal frames, LATERAL LOCKING, **12V A.C.-D.C.**, operating with European profile cylinder  
Front plate mm **346 x 22 x 3** in STAINLESS STEEL. Rotating DEADBOLT 24 mm throw.

**SELF-LOCKING LATCHBOLT, EXTENDED + MM 5.** Latchlocking by electric pulse, key or handle follower mm 8. Separate loading spring extended + mm5. 2 escutcheons. Pair of front plate spacers.  
Fixing screws. Instruction sheet.

**Accessories to be ordered separately:** Striking plates

Backset mm 25	<b>7818022525</b>	D	1	10	10
Backset mm 30	<b>7818023025</b>	D	1	10	10
Backset mm 35	<b>7818023525</b>	D	1	10	10

Electric mortice lock for metal frames, LATERAL LOCKING, **24V A.C.-D.C.**, operating with European profile cylinder  
Front plate mm **346 x 22 x 3** in STAINLESS STEEL. Rotating DEADBOLT 24 mm throw. Self-locking Latchbolt.

Latchlocking by electric pulse, key or handle follower mm 8. Separate loading spring extended + mm 5.  
2 escutcheons. Pair of front plate spacers.  
Fixing screws. Instruction sheet.

**Accessories to be ordered separately:** Striking plates

Backset mm 25	<b>781802252V</b>	D	1	10	10
Backset mm 30	<b>781802302V</b>	D	1	10	10
Backset mm 35	<b>781802352V</b>	D	1	10	10





Code

Min. ord.  
Multiple  
package  
Single  
package  
Status

**Electa electric lock stainless steel front plate mm 22**

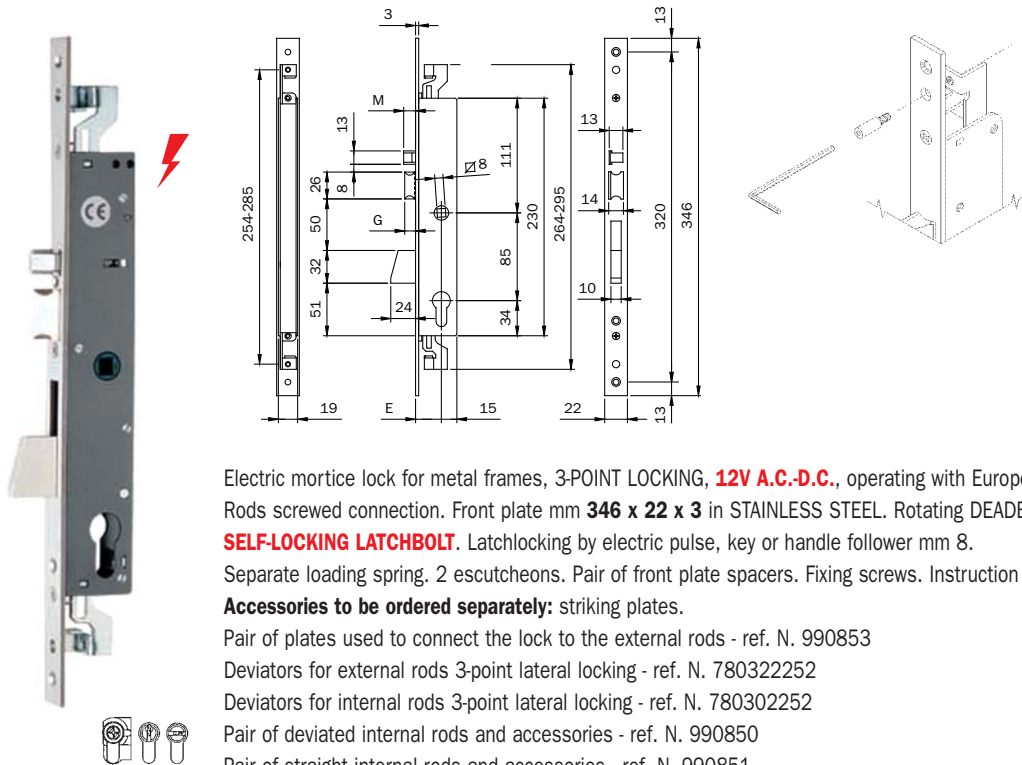

Electric mortice lock for metal frames, 3-POINT LOCKING, **12V A.C.-D.C.**, operating with European profile cylinder  
Rods screwed connection. Front plate mm **346 x 22 x 3** in STAINLESS STEEL. Rotating DEADBOLT with 24 mm throw.  
**SELF-LOCKING LATCHBOLT**. Latchlocking by electric pulse, key or handle follower mm 8.  
Separate loading spring. 2 escutcheons. Pair of front plate spacers. Fixing screws. Instruction sheet.

- Accessories to be ordered separately:** striking plates.  
Pair of plates used to connect the lock to the external rods - ref. N. 990853  
Deviators for external rods 3-point lateral locking - ref. N. 780322252  
Deviators for internal rods 3-point lateral locking - ref. N. 780302252  
Pair of deviated internal rods and accessories - ref. N. 990850  
Pair of straight internal rods and accessories - ref. N. 990851

Backset mm 25	<b>783802252</b>	A	1	10	10
Backset mm 30	<b>783802302</b>	A	1	10	10
Backset mm 35	<b>783802352</b>	A	1	10	10

Electric mortice lock for metal frames, 3-POINT LOCKING, **12V A.C.-D.C.**, operating with European profile cylinder.  
Rods screwed connection. Front plate mm **346 x 22 x 3** in STAINLESS STEEL. Rotating DEADBOLT with 24 mm throw.  
Self-locking latchbolt. **SELF-LOCKING LATCHBOLT EXTENDED + 5 MM**. Latchlocking by electric pulse,  
key or handle follower mm 8.  
Separate loading spring extended + mm 5. 2 escutcheons.  
Pair of forend spacers. Fixing screws. Instruction sheet.

- Accessories to be ordered separately:** striking plates.  
Pair of plates used to connect the lock to the external rods - ref. N. 990853  
Deviators for external rods 3-point lateral locking - ref. N. 780322252  
Deviators for internal rods 3-point lateral locking - ref. N. 780302252  
Pair of deviated internal rods and accessories - ref. N. 990850  
Pair of straight internal rods and accessories - ref. N. 990851

Backset mm 25	<b>7838022525</b>	D	1	10	10
Backset mm 30	<b>7838023025</b>	D	1	10	10
Backset mm 35	<b>7838023525</b>	D	1	10	10



Code

Min. ord.  
Multiple  
package  
Single  
package  
Status

**Electa stainless steel front plate mm 22**

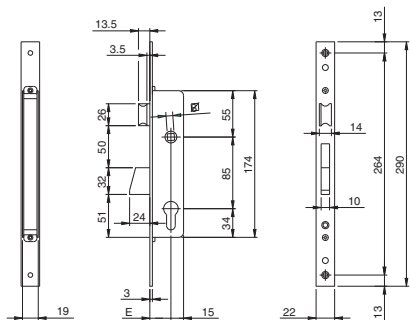

Mortice lock for metal frames, LATERAL LOCKING, operating with European profile cylinder.  
Front plate **290 x 22 x 3** in STAINLESS STEEL. Rotating **DEADBOLT** with mm 24 throw. Separate reversible and adjustable **LATCHBOLT** 10 to 15 mm. Latchlocking by key or handle follower mm 8. 2 escutcheons.  
Pair of front plate supports. Fixing screws. Instruction sheet.

**Accessories to be ordered separately:** Striking plates



Backset mm 25	<b>781102252</b>	A	1	10	10
Backset mm 30	<b>781102302</b>	A	1	10	10
Backset mm 35	<b>781102352</b>	A	1	10	10

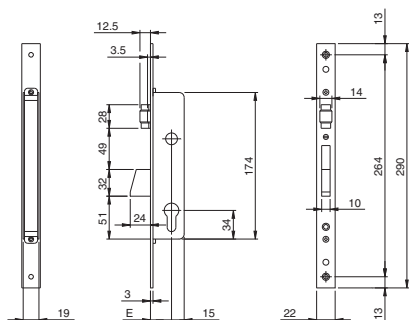

Mortice lock for metal frames, LATERAL LOCKING, operating with European profile cylinder.  
Front plate **290 x 22 x 3** in STAINLESS STEEL. Rotating **DEADBOLT** with mm 24 throw. **ADJUSTABLE ROLLER**.  
2 escutcheons. Pair of front plate supports. Fixing screws. Instruction sheet.

**Accessories to be ordered separately:** Striking plates

Backset mm 25	<b>781202252</b>	C	1	10	10
Backset mm 30	<b>781202302</b>	B	1	10	10
Backset mm 35	<b>781202352</b>	B	1	10	10



Code

Min. ord.  
Multiple  
package  
Single  
package  
Status

**Electa stainless steel front plate mm 22**

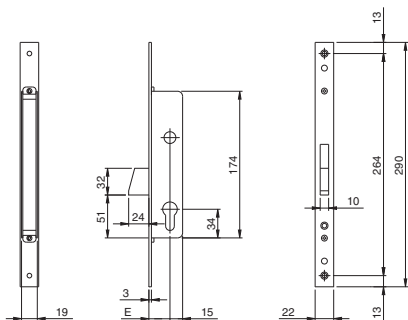

Mortice lock for metal frames, LATERAL LOCKING, operating with European profile cylinder.

Front plate **290 x 22 x 3** in STAINLESS STEEL. Rotating DEADBOLT with mm 24 throw.

2 escutcheons. Pair of front plate supports. Fixing screws. Instruction sheet.

**Accessories to be ordered separately:** Striking plates.

Backset mm 25	<b>781302252</b>	C	1	10	10
Backset mm 30	<b>781302302</b>	B	1	10	10
Backset mm 35	<b>781302352</b>	C	1	10	10

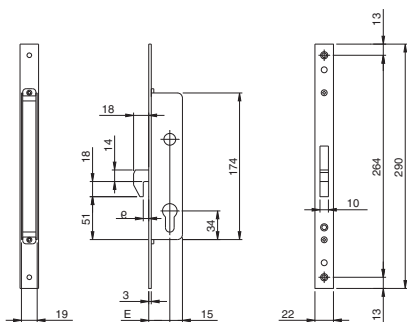

Mortice lock for metal frames, LATERAL LOCKING, operating with European profile cylinder.

Front plate **290 x 22 x 3** in STAINLESS STEEL. **HOOK DEADBOLT, CLEARANCE 6**, with mm 18 throw.

2 escutcheons. Pair of front plate supports. Fixing screws. Instruction sheet.

**Accessories to be ordered separately:** Striking plates.

Backset mm 25	<b>781402252</b>	C	1	10	10
Backset mm 30	<b>781402302</b>	A	1	10	10
Backset mm 35	<b>781402352</b>	A	1	10	10



Code

Min. ord.  
Multiple  
package  
Single  
package  
Status

**Electa stainless steel front plate mm 22**

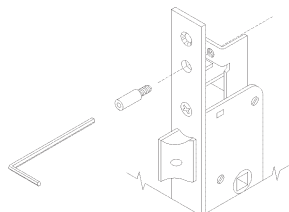
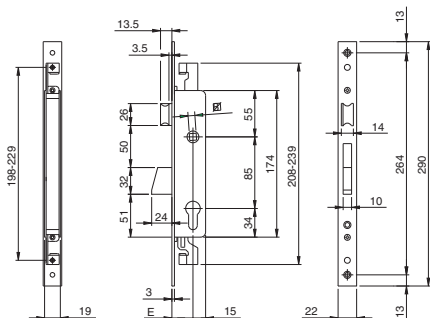

Mortice lock for metal frames, 3-POINT LOCKING, operating with European profile cylinder. Rods screwed connection. Front plate mm **290 x 22 x 3** in STAINLESS STEEL. Rotating DEADBOLT with mm 24 throw. Separate **REVERSIBLE AND ADJUSTABLE LATCHBOLT** 10 to 15 mm. Latchlocking by key or handle follower mm 8. 2 escutcheons. Pair of front plate supports. Fixing screws. Instruction sheet.

**Accessories to be ordered separately:**

- Pair of plates used to connect the lock to the external rods - ref. N. 990853
- Deviators for external rods 3-point lateral locking - ref. N. 780322252
- Deviators for internal rods 3-point lateral locking - ref. N. 780302252
- Pair of deviated internal rods and accessories - ref. N. 990850
- Pair of straight internal rods and accessories - ref. N. 990851

Striking plates.

Backset mm 25	<b>783102252</b>	A	1	10	10
Backset mm 30	<b>783102302</b>	A	1	10	10
Backset mm 35	<b>783102352</b>	A	1	10	10

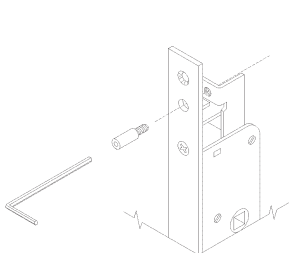
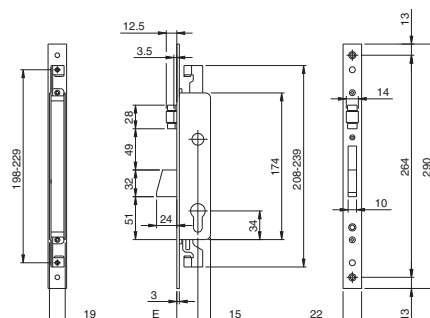

Mortice lock for metal frames, 3-POINT LOCKING, operating with European profile cylinder. Rods screwed connection. Front plate mm **290 x 22 x 3** in STAINLESS STEEL. Rotating DEADBOLT with mm 24 throw. **ADJUSTABLE ROLLER**. 2 escutcheons. Pair of front plate supports. Fixing screws. Instruction sheet.

**Accessories to be ordered separately:**

- Pair of plates used to connect the lock to the external rods - ref. N. 990853
- Deviators for external rods 3-point lateral locking - ref. N. 780322252
- Deviators for internal rods 3-point lateral locking - ref. N. 780302252
- Pair of deviated internal rods and accessories - ref. N. 990850
- Pair of straight internal rods and accessories - ref. N. 990851

Striking plates.

Backset mm 25	<b>783202252</b>	B	1	10	10
Backset mm 30	<b>783202302</b>	B	1	10	10
Backset mm 35	<b>783202352</b>	A	1	10	10





Code

Min. ord.  
Multiple package  
Single package  
Status

**Electa stainless steel front plate mm 22**

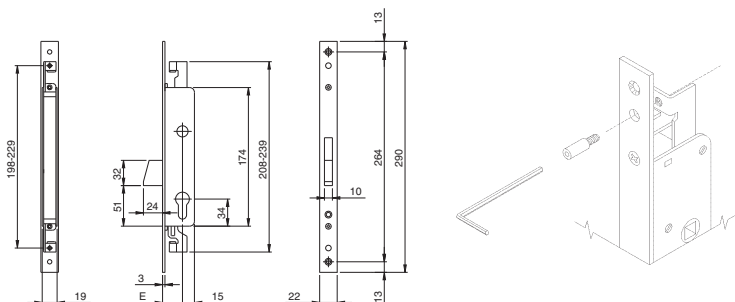

Mortice lock for metal frames, 3-POINT LOCKING, operating with European profile cylinder. Rods screwed connection. Front plate mm **290 x 22 x 3** in STAINLESS STEEL. Rotating DEADBOLT with mm 24 throw. 2 escutcheons. Pair of front plate supports. Fixing screws. Instruction sheet.

**Accessories to be ordered separately:**

- Pair of plates used to connect the lock to the external rods - ref. N. 990853
- Deviators for external rods 3-point lateral locking - ref. N. 780322252
- Deviators for internal rods 3-point lateral locking - ref. N. 780302252
- Pair of deviated internal rods and accessories - ref. N. 990850
- Pair of straight internal rods and accessories - ref. N. 990851

Striking plates

Backset mm 25	<b>783302252</b>	A	1	10	10
Backset mm 30	<b>783302302</b>	B	1	10	10
Backset mm 35	<b>783302352</b>	C	1	10	10

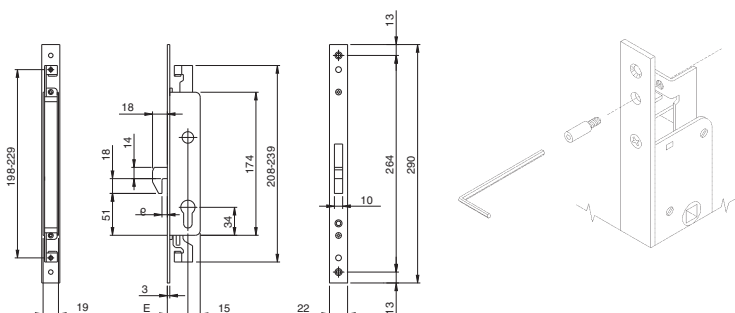

Mortice lock for metal frames, 3-POINT LOCKING, operating with European profile cylinder. Rods screwed connection. Front plate mm **290 x 22 x 3** in STAINLESS STEEL. **HOOK DEADBOLT, CLEARANCE 6**, with mm 18 throw. 2 escutcheons. Pair of front plate supports. Fixing screws. Instruction sheet.

**Accessories to be ordered separately:**

- Pair of plates used to connect the lock to the external rods - ref. N. 990853
- Deviators for external rods 3-point lateral locking - ref. N. 780322252
- Deviators for internal rods 3-point lateral locking - ref. N. 780302252
- Pair of deviated internal rods and accessories - ref. N. 990850
- Pair of straight internal rods and accessories - ref. N. 990851

Striking plates

Backset mm 25	<b>783402252</b>	B	1	10	10
Backset mm 30	<b>783402302</b>	C	1	10	10
Backset mm 35	<b>783402352</b>	B	1	10	10



Code

Min. ord.  
Multiple package  
Single package  
Status

**Electa stainless steel front plate mm 22**

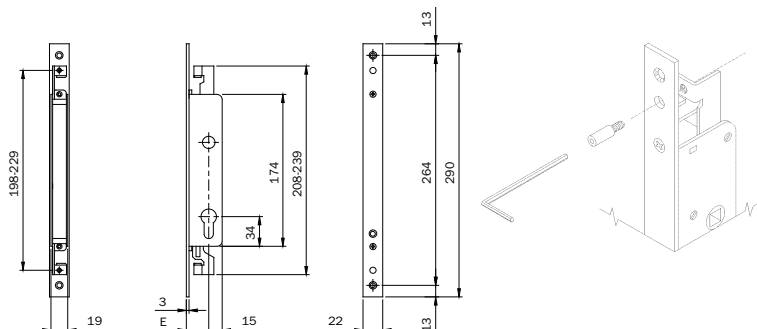

Mortice lock for metal frames, **DOUBLE TOP/BOTTOM LOCKING**, operating with European profile cylinder.  
Rods screwed connection. Front plate mm **290 x 22 x 3** in STAINLESS STEEL. 2 escutcheons.  
Pair of front plate supports. Fixing screws. Instruction sheet.

**Accessories to be ordered separately:**

- Pair of plates used to connect the lock to the external rods - ref. N. 990853
- Deviators for external rods 3-point lateral locking - ref. N. 780322252
- Deviators for internal rods 3-point lateral locking - ref. N. 780302252
- Pair of deviated internal rods and accessories - ref. N. 990850
- Pair of straight internal rods and accessories - ref. N. 990851
- Striking plates

Backset mm 25	<b>782002252</b>	B	1	10	10
Backset mm 30	<b>782002302</b>	B	1	10	10
Backset mm 35	<b>782002352</b>	D	1	10	10

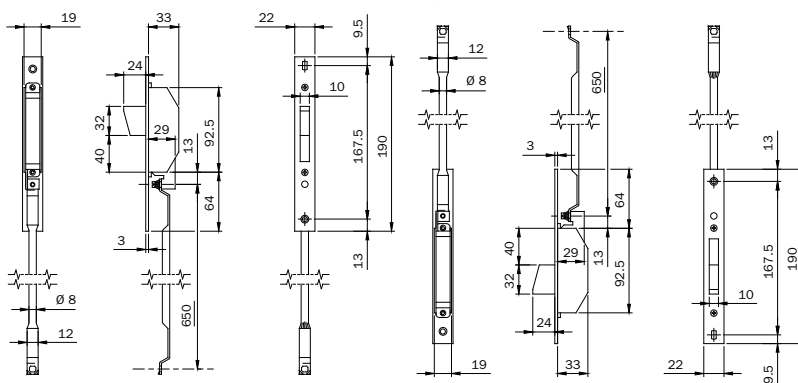

Deviators for 3-POINT LATERAL LOCKING. Internal rods to be used with locks with **SCREWED CONNECTION**.

Front plate mm **190 x 22 x 3** in STAINLESS STEEL. Rotating deadbolt with mm 24 throw.

With internal rods. 2 pairs of nylon spacers. Rod-guiding nylon bushes. Fixing screws. **780302252** A 1 5 5



Code

Status

Single  
package

Multiple  
package

Min. ord.

**Electa stainless steel front plate mm 22**

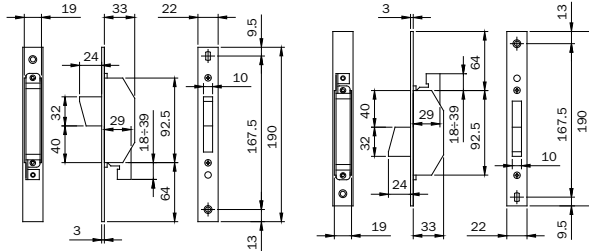

Deviators for 3-POINT LATERAL LOCKING. For assembly with external rods to be used with locks

**SCREWED CONNECTION.** Front plate mm **190 x 22 x 3** in STAINLESS STEEL. Rotating deadbolt with mm 24 throw.

Without internal rods. 2 pairs of nylon spacers. Fixing screws.

**78032252** B 1 5 5



Code

Status  
Single  
package

Min. ord.

**Electa stainless steel front plate mm 24**

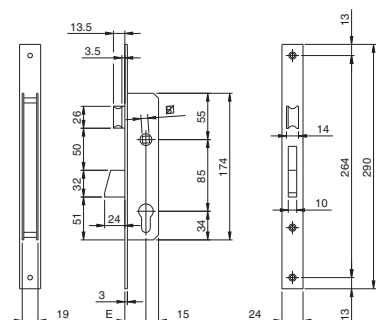

Mortice lock for metal frames, LATERAL LOCKING, operating with European profile cylinder.  
Front plate mm **290 x 24 x 3** in STAINLESS STEEL. Rotating DEADBOLT with mm 24 throw.  
Separate **REVERSIBLE AND ADJUSTABLE LATCHBOLT** 10 to 15 mm  
Latchlocking by key or handle follower mm 8.  
2 escutcheons. Nylon front plate supports. Fixing screws. Instruction sheet.  
**Accessories to be ordered separately:** Striking plates



Backset mm 25	<b>781251B</b>	A	1	10	10
Backset mm 30	<b>781301B</b>	A	1	10	10
Backset mm 35	<b>781351B</b>	A	1	10	10

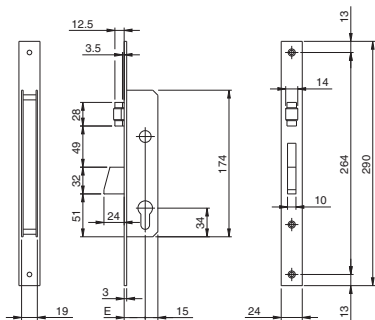

Mortice lock for metal frames, LATERAL LOCKING, operating with European profile cylinder.  
Front plate mm **290 x 24 x 3** in STAINLESS STEEL. Rotating **DEADBOLT** with mm 24 throw. Adjustable roller  
2 escutcheons. Nylon front plate supports. Fixing screws. Instruction sheet.  
**Accessories to be ordered separately:** Striking plates



Backset mm 25	<b>781252B</b>	B	1	10	10
Backset mm 30	<b>781302B</b>	C	1	10	10
Backset mm 35	<b>781352B</b>	B	1	10	10





Code

Min. ord.  
Multiple  
package  
Single  
package  
Status

**Electa stainless steel front plate mm 24**

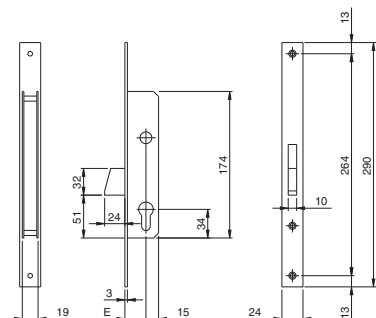

Mortice lock for metal frames, LATERAL LOCKING, operating with European profile cylinder.  
Front plate mm **290 x 24 x 3** in STAINLESS STEEL. ROTATING DEADBOLT with mm 24 throw.  
2 escutcheons. Nylon front plate supports. Fixing screws. Instruction sheet.

**Accessories to be ordered separately:** Striking plates

Backset mm 25	<b>781253B</b>	C	1	10	10
Backset mm 30	<b>781303B</b>	C	1	10	10
Backset mm 35	<b>781353B</b>	C	1	10	10

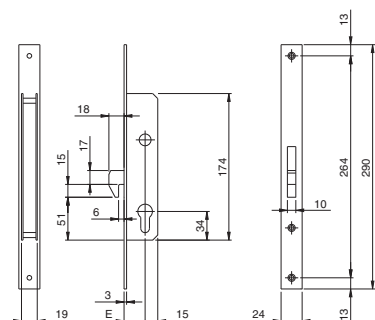

Mortice lock for metal frames, LATERAL LOCKING, operating with European profile cylinder.  
Front plate mm **290 X 24 X 3** in STAINLESS STEEL. **HOOK DEADBOLT, CLEARANCE 6**, with mm 18 throw.  
2 escutcheons. Nylon front plate supports. Fixing screws. Instruction sheet.

**Accessories to be ordered separately:** Striking plates

Backset mm 25	<b>781254B</b>	C	1	10	10
Backset mm 30	<b>781304B</b>	C	1	10	10
Backset mm 35	<b>781354B</b>	B	1	10	10



Code

Min. ord.  
Multiple  
package  
Single  
package  
Status

**Electa stainless steel front plate mm 24**

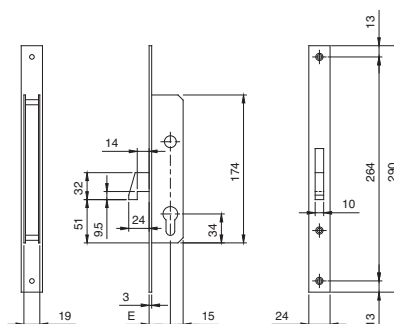

Mortice lock for metal frames, LATERAL LOCKING, operating with European profile cylinder.  
Front plate mm **290 x 24 x 3** in STAINLESS STEEL. **HOOK DEADBOLT, CLEARANCE 14**, with mm 24 throw.  
2 escutcheons. Pair of front plate supports. Fixing screws. Instruction sheet.

**Accessories to be ordered separately:** Striking plates

Backset mm 25	<b>781470250</b>	C	1	10	10
Backset mm 30	<b>781470300</b>	B	1	10	10
Backset mm 35	<b>781470350</b>	B	1	10	10

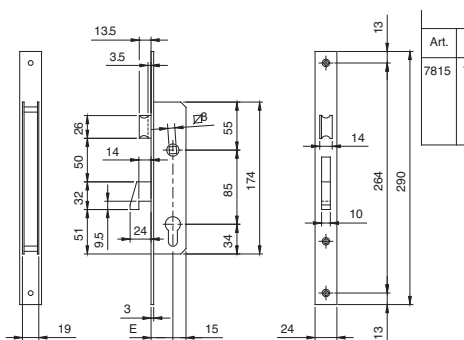

Mortice lock for metal frames, LATERAL LOCKING, operating with European profile cylinder.  
Front plate mm **290 X 24 X 3** in STAINLESS STEEL. **HOOK DEADBOLT, CLEARANCE 14**, with mm 24 throw.  
Separate **LATCHBOLT FLUSH WITH FRONT PLATE, REVERSIBLE AND ADJUSTABLE** 10 to 15 mm.

Latchlocking by key or handle follower mm 8.  
2 escutcheons. Pair of front plate supports. Fixing screws. Instruction sheet.

**Accessories to be ordered separately:** Striking plates

Backset mm 25	<b>781570250</b>	B	1	10	10
Backset mm 30	<b>781570300</b>	B	1	10	10
Backset mm 35	<b>781570350</b>	B	1	10	10



Code

Min. ord.  
Multiple  
package  
Single  
package  
Status

**Electa stainless steel front plate mm 24**

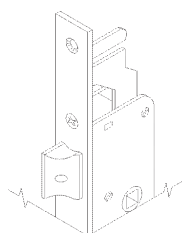
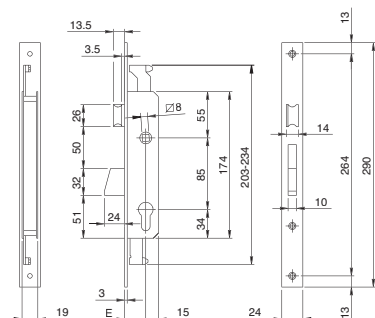

Mortise lock for metal frames, 3-POINT LOCKING, operating with European profile cylinder.  
Rods clutch connection. Front plate mm **290 x 24 x 3** in STAINLESS STEEL. Rotating DEADBOLT with mm 24 throw.  
Separate **REVERSIBLE AND ADJUSTABLE LATCHBOLT** 10 to 15 mm  
Latchlocking by key or handle follower mm 8.  
2 escutcheons. Nylon front plate support. Fixing screws. Instruction sheet.

**Accessories to be ordered separately:**

Pair of plates used to connect the lock to the external rods - ref. N. 990828  
Deviators for lateral 3-point locking, internal rods - ref. N. 780253BFZ  
Pair of internal deviated and slotted rods D8 - ref. N. 990810  
Pair of internal straight and slotted rods D8 - ref. N. 990811  
Striking plates.

Backset mm 25	<b>783251B</b>	B	1	10	10
Backset mm 30	<b>783301B</b>	B	1	10	10
Backset mm 35	<b>783351B</b>	B	1	10	10

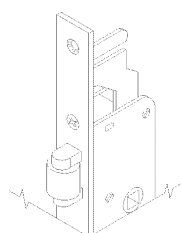
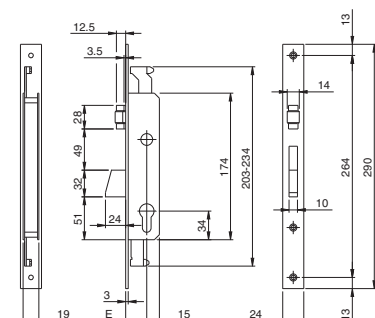

Mortise lock for metal frames, 3-POINT LOCKING, operating with European profile cylinder.  
Rods clutch connection. Front plate mm **290 x 24 x 3** in STAINLESS STEEL. Rotating DEADBOLT with mm 24 throw.  
**ADJUSTABLE ROLLER**. 2 escutcheons. Nylon front plate support. Fixing screws. Instruction sheet.

**Accessories to be ordered separately:**

Pair of plates used to connect the lock to the external rods - ref. N. 990828  
Deviators for lateral 3-point locking, internal rods - ref. N. 780253BFZ  
Pair of internal deviated and slotted rods D8 - ref. N. 990810  
Pair of internal straight and slotted rods D8 - ref. N. 990811  
Striking plates.

Backset mm 25	<b>783252B</b>	C	1	10	10
Backset mm 30	<b>783302B</b>	C	1	10	10
Backset mm 35	<b>783352B</b>	C	1	10	10





Code

Min. ord.  
Multiple  
package  
Single  
package  
Status

**Electa stainless steel front plate mm 24**

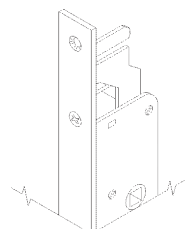
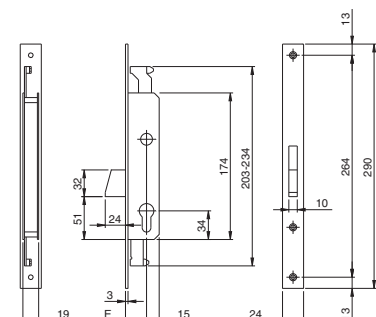

Mortice lock for metal frames, 3-POINT LOCKING, operating with European profile cylinder.  
Rods clutch connection. Front plate mm **290 X 24 X 3** in STAINLESS STEEL. Rotating DEADBOLT with mm 24 throw.  
2 escutcheons. Nylon front plate support. Fixing screws. Instruction sheet.

**Accessories to be ordered separately:**

- Pair of plates used to connect the lock to the external rods - ref. N. 990828
- Deviators for lateral 3-point locking, internal rods - ref. N. 780253BFZ
- Pair of internal deviated and slotted rods D8 - ref. N. 990810
- Pair of internal straight and slotted rods D8 - ref. N. 990811

Striking plates

Backset mm 25	<b>783253B</b>	B	1	10	10
Backset mm 30	<b>783303B</b>	D	1	10	10
Backset mm 35	<b>783353B</b>	C	1	10	10

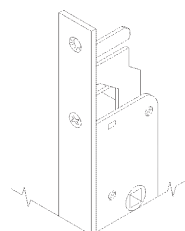
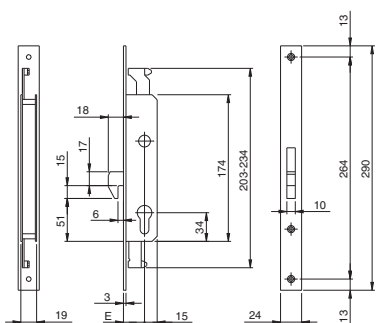

Mortice lock for metal frames, 3-POINT LOCKING, operating with European profile cylinder.  
Rods clutch connection. Front plate mm **290 x 24 x 3** in STAINLESS STEEL. **HOOK DEADBOLT, CLEARANCE 6**, with mm 18 throw.  
2 escutcheons. Nylon front plate support. Fixing screws. Instruction sheet.

**Accessories to be ordered separately:**

- Pair of plates used to connect the lock to the external rods - ref. N. 990828
- Deviators for lateral 3-point locking, internal rods - ref. N. 780253BFZ
- Pair of internal deviated and slotted rods D8 - ref. N. 990810
- Pair of internal straight and slotted rods D8 - ref. N. 990811

Striking plates.

Backset mm 25	<b>783254B</b>	C	1	10	10
Backset mm 30	<b>783304B</b>	B	1	10	10
Backset mm 35	<b>783354B</b>	C	1	10	10



Code

Min. ord.  
Multiple  
package  
Single  
package  
Status

**Electa stainless steel front plate mm 24**

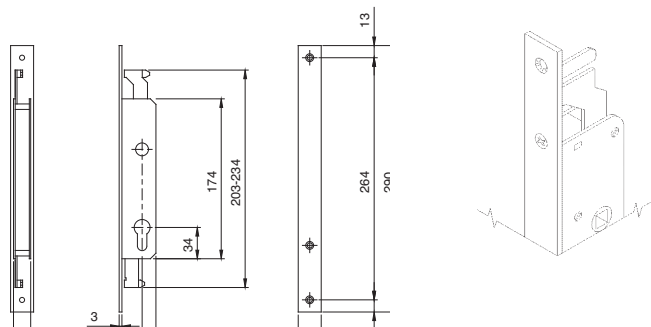

Mortice lock for metal frames, DOUBLE **TOP/BOTTOM** LOCKING, operating with European profile cylinder.  
Rods clutch connection. Front plate mm **290 x 24 x 3** in STAINLESS STEEL. 2 escutcheons. Nylon front plate support.  
Fixing screws. Instruction sheet.

**Accessories to be ordered separately:**

Pair of plates used to connect the lock to the external rods - ref. N. 990828

Deviators for lateral 3-point locking, internal rods - ref. N. 780253BFZ

Pair of internal deviated and slotted rods D8 - ref. N. 990810

Pair of internal straight and slotted rods D8 - ref. N. 990811

Striking plates

Backset mm 25	<b>782250B</b>	B	1	10	10
Backset mm 30	<b>782300B</b>	C	1	10	10
Backset mm 35	<b>782350B</b>	C	1	10	10

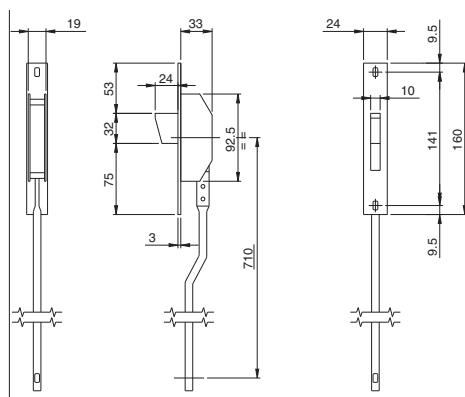

Deviators for 3-POINT LATERAL LOCKING. Internal rods to be used with locks with **CLUTCH CONNECTION**.

Front plate mm **160 x 24 x 3** in STAINLESS STEEL. Rotating latchbolt with mm 24 throw.

With rods. Rod-guiding pins. Screws with roses. Instruction sheet.

<b>780253</b>	B	1	5	5
---------------	---	---	---	---



Code

Min. ord.  
Multiple  
package  
Single  
package  
Status

**Electa zinc-plated steel front plate mm 24**

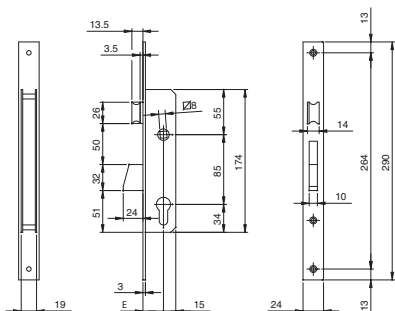

Mortice lock for metal frames, LATERAL LOCKING, operating with European profile cylinder.  
 Front plate mm **290 x 24 x 3** in zinc-plated steel. Rotating DEADBOLT with 24 mm throw. Separate  
**REVERSIBLE AND ADJUSTABLE LATCHBOLT** 10 to 15 mm. Latchlocking by key or handle follower mm 8.  
 2 escutcheons. Cylinder fixing screw.

**Accessories to be ordered separately:** Striking plates



Backset mm 25	<b>781251FZ</b>	B	1	10	10
Backset mm 30	<b>781301FZ</b>	A	1	10	10
Backset mm 35	<b>781351FZ</b>	A	1	10	10

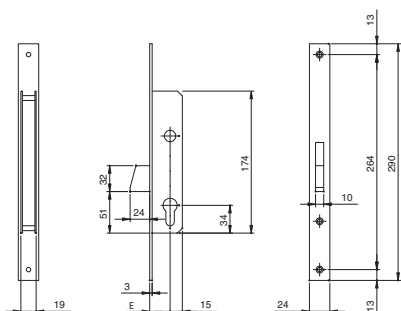

Mortice lock for metal frames, LATERAL LOCKING, operating with European profile cylinder.  
 Front plate mm **290 x 24 x 3** in ZINC-PLATED STEEL. Rotating DEADBOLT with 24 mm throw.  
 2 escutcheons. Cylinder fixing screw.

**Accessories to be ordered separately:** Striking plates



Backset mm 25	<b>781253FZ</b>	B	1	10	10
Backset mm 30	<b>781303FZ</b>	B	1	10	10
Backset mm 35	<b>781353FZ</b>	B	1	10	10



Code

Min. ord.  
Multiple  
package  
Single  
package  
Status

**Electa zinc-plated steel front plate mm 24**

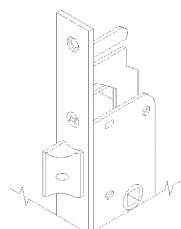
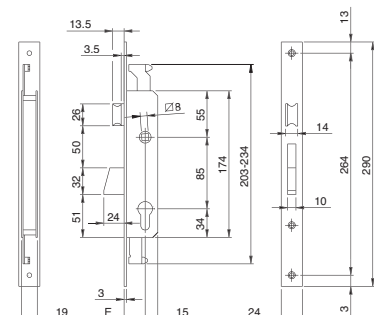

Mortice lock for metal frames, 3-POINT LOCKING, operating with European profile cylinder.  
Rods clutch connection. Front plate mm **290 x 24 x 3** in ZINC-PLATED STEEL. Rotating DEADBOLT with mm 24 throw.  
Separate **REVERSIBLE AND ADJUSTABLE LATCHBOLT** 10 to 15 mm. Deadlocking by key or handle follower mm 8.  
2 escutcheons. Cylinder fixing screw.

**Accessories to be ordered separately:**

Pair of plates used to connect the lock to the external rods - ref. N. 990828

Deviators for lateral 3-point locking, internal rods - ref. N. 780253BFZ

Pair of internal deviated and slotted rods D8 - ref. N. 990810

Pair of internal straight and slotted rods D8 - ref. N. 990811

M8 screwed connection for threaded rods - ref. N. 990823

Pins, tips and rod-guiding plates for D8 rods - ref. N. 990837

Striking plates

Backset mm 25

**783251IFZ** A 1 10 10

Backset mm 30

**783301IFZ** B 1 10 10

Backset mm 35

**783351IFZ** A 1 10 10

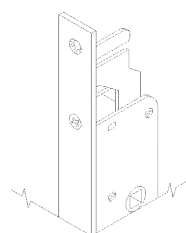
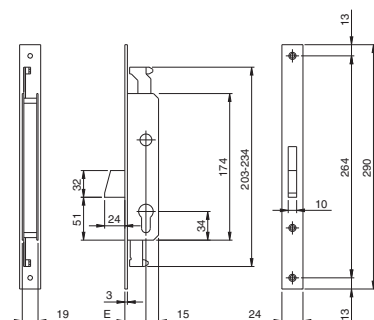

Mortice lock for metal frames, 3-POINT LOCKING, operating with European profile cylinder.

Rods clutch connection. Front plate mm **290 x 24 x 3** in ZINC-PLATED STEEL.

Rotating DEADBOLT with mm 24 throw. 2 escutcheons. Cylinder fixing screw.

**Accessories to be ordered separately:**

Pair of plates used to connect the lock to the external rods - ref. N. 990828

Deviators for lateral 3-point locking, internal rods - ref. N. 780253BFZ

Pair of internal deviated and slotted rods D8 - ref. N. 990810

Pair of internal straight and slotted rods D8 - ref. N. 990811

M8 screwed connection for threaded rods - ref. N. 990823

Pins, tips and rod-guiding plates for D8 rods - ref. N. 990837

Striking plates

Backset mm 25

**783253IFZ** A 1 10 10

Backset mm 30

**783303IFZ** B 1 10 10

Backset mm 35

**783353IFZ** A 1 10 10





Code

Min. ord.  
Multiple  
package  
Single  
package  
Status

**Electa zinc-plated steel front plate mm 24**

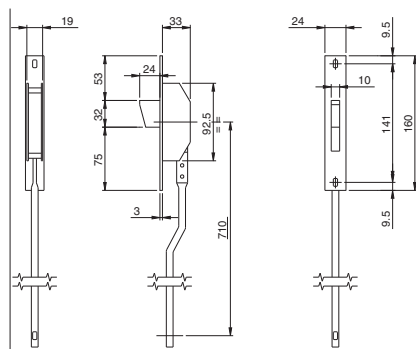
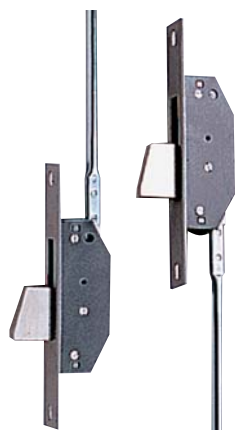

Deviators for 3-point lateral locking. Internal rods to be used with locks with clutch connection.  
Front plate mm **160 x 24 x 3** in ZINC-PLATED STEEL. Rotating deadbolt with mm 24 throw.  
Rod-guiding pins. Screws with roses.

**780253BFZ** D 1 5 5

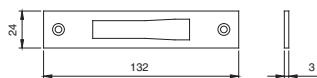

Striking plate in **STAINLESS STEEL** mm **132 x 24 x 3**.

For locks with deadbolt only, hook and deviators for aluminium series 78\*-96\*-

**038020** A 10 - 10

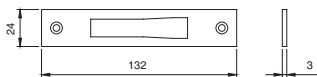

Striking plate in **ZINC-PLATED STEEL** mm **132 x 24 x 3**.

For locks with deadbolt only, hook and deviators for aluminium series 78\*-96\*-

**038022** B 10 - 10





Code

Min. ord.  
Multiple package  
Single package  
Status

**Electa for shutters stainless steel front plate mm 24**

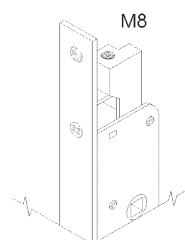
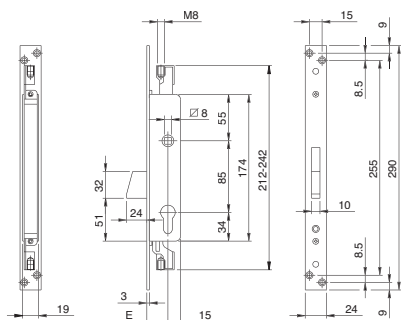

Mortice lock for metal frames, **SHUTTERS**, 3-POINT LOCKING, operating with European profile cylinder.  
Pre-assembled M8 rod connection. Rods travel range mm 15. Front plate mm **290 x 24 x 3** in STAINLESS STEEL.  
Rotating DEADBOLT with mm 24 throw. Throw by handle follower mm 8, handle locked by cylinder. 1 escutcheon.

**Accessories to be ordered separately:**

- 2 tips D10 for threaded rods M8 - ref. N. 990836
- Pins, tips and rod-guiding plates for D8 rods - ref. N. 990837
- Striking plate in STAINLESS STEEL - ref. N. 038020



Backset mm 25	<b>783380252</b>	D	1	10	10
Backset mm 30	<b>783380302</b>	D	1	10	10
Backset mm 35	<b>783380352</b>	C	1	10	10

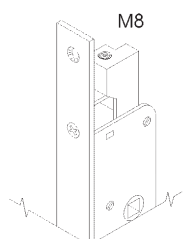
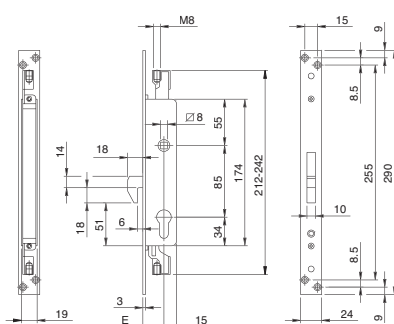

Mortice lock for metal frames, **SHUTTERS**, 3-POINT LOCKING, operating with European profile cylinder.  
Pre-assembled M8 rod connection. Rods travel range mm 15. Front plate mm **290 x 24 x 3** in STAINLESS STEEL.  
**HOOK DEADBOLT, CLEARANCE 6**, with mm 18 throw. Throw by handle follower mm 8, handle locked by cylinder. 1 escutcheon.

**Accessories to be ordered separately:**

- 2 tips D10 for threaded rods M8 - ref. N. 990836
- Pins, tips and rod-guiding plates for D8 rods - ref. N. 990837
- Striking plate in stainless steel - ref. N. 038020



Backset mm 25	<b>783480252</b>	D	1	10	10
Backset mm 30	<b>783480302</b>	C	1	10	10
Backset mm 35	<b>783480352</b>	D	1	10	10



Code

Min. ord.  
Multiple package  
Single package  
Status

**Electa for shutters**

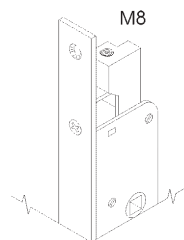
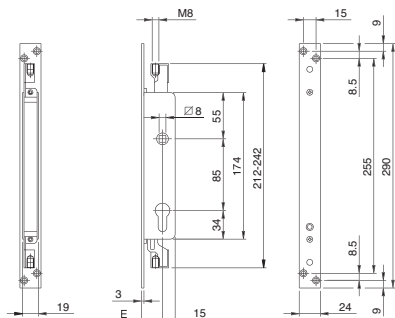

Mortice lock for metal frames, **SHUTTERS**, DOUBLE TOP/BOTTOM LOCKING, operating with European profile cylinder. Pre-assembled M8 rod connection. Rods travel range mm 15. Front plate mm **290 x 24 x 3** in STAINLESS STEEL. Throw by handle follower mm 8, handle locked by cylinder. 1 escutcheon.

**Accessories to be ordered separately:**

- 2 tips D10 for threaded rods M8 - ref. N. 990836
- Pins, tips and rod-guiding plates for D8 rods - ref. N. 990837
- Striking plate in stainless steel - ref. N. 038020



Backset mm 25 stainless steel front plate	<b>782080252</b>	D	1	10	10
Backset mm 30 stainless steel front plate	<b>782080302</b>	D	1	10	10
Backset mm 35 stainless steel front plate	<b>782080352</b>	D	1	10	10

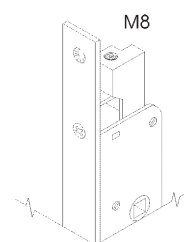
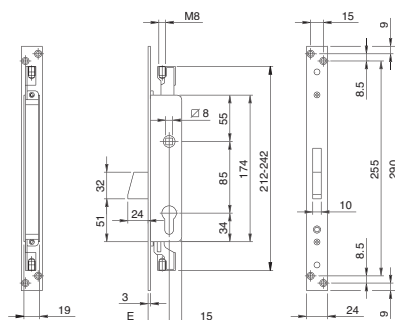

Mortice lock for metal frames, **SHUTTERS**, 3-POINT LOCKING, operating with European profile cylinder. Pre-assembled M8 rod connection. Rods travel range mm 15. Front plate mm 290 X 24 X 3 IN ZINC-PLATED steel. Rotating DEADBOLT with mm 24 throw. Throw by handle follower mm 8, handle locked by cylinder. 1 escutcheon.

**Accessories to be ordered separately:**

- 2 tips D10 for threaded rods M8 - ref. N. 990836
- Pins, tips and rod-guiding plates for D8 rods - ref. N. 990837
- Striking plate in zinc-plated steel - ref. N. 038020



Backset mm 25 zinc-plated steel front plate	<b>783380254</b>	B	1	10	10
Backset mm 30 zinc-plated steel front plate	<b>783380304</b>	A	1	10	10
Backset mm 35 zinc-plated steel front plate	<b>783380354</b>	A	1	10	10



Code

Multiple package  
Single package  
Status

Min. ord.

**Electa for shutters zinc-plated steel front plate mm 24**

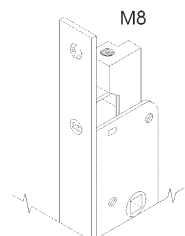
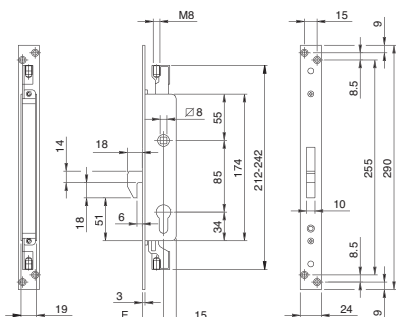

Mortice lock for metal frames, **SHUTTERS**, 3-POINT LOCKING, operating with European profile cylinder.  
Pre-assembled M8 rod connection. Rods travel range mm 15. Front plate mm 290 X 24 X 3 IN ZINC-PLATED STEEL.  
**HOOK DEADBOLT, CLEARANCE 6**, with mm 18 throw. Throw by handle follower mm 8, handle locked by cylinder. 1 escutcheon.

**Accessories to be ordered separately:**

- 2 tips D10 for threaded rods M8 - ref. N. 990836
- Pins, tips and rod-guiding plates for D8 rods - ref. N. 990837
- Striking plate in zinc-plated steel - ref. N. 038020

Backset mm 25	<b>783480254</b>	C	1	10	10
Backset mm 30	<b>783480304</b>	D	1	10	10
Backset mm 35	<b>783480354</b>	D	1	10	10

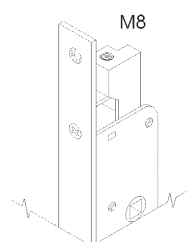
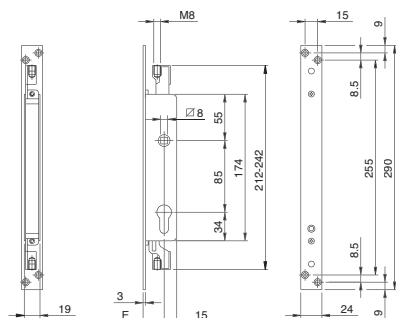

Mortice lock for metal frames, **SHUTTERS**, DOUBLE TOP/BOTTOM LOCKING, operating with European profile cylinder.  
Pre-assembled M8 rod connection. Front plate mm **290 x 24 x 3** in ZINC-PLATED STEEL.  
Rods travel range mm 15. Throw by handle follower mm 8, handle locked by cylinder. 1 escutcheon.

**Accessories to be ordered separately:**

- 2 tips D10 for threaded rods M8 - ref. N. 990836
- Pins, tips and rod-guiding plates for D8 rods - ref. N. 990837
- Striking plate in zinc-plated steel - ref. N. 038020

Backset mm 25	<b>782080254</b>	D	1	10	10
Backset mm 30	<b>782080304</b>	D	1	10	10
Backset mm 35	<b>782080354</b>	C	1	10	10



Code

Min. ord.  
Multiple  
package  
Single  
package  
Status

**Electa for shutters zinc-plated steel front plate mm 24**

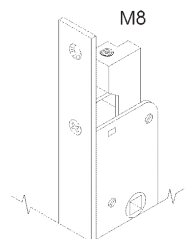
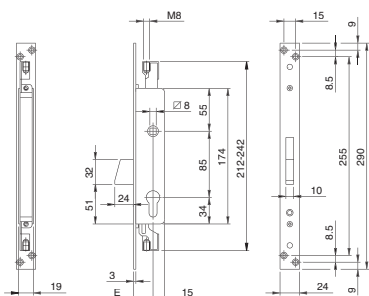

Mortice lock for metal frames, **SHUTTERS**, 3-POINT LOCKING, operating with assembled pin keys cylinder (insert 990875). Pre-assembled M8 rod connection. Rods travel range mm 15.  
Front plate mm **290 x 24 x 3** in ZINC-PLATED STEEL. Rotating DEADBOLT mm 24 throw. Throw by handle follower mm 8, handle locked by cylinder. 3 keys.  
2 key-guiding bushes (Key blank ref. N. 020275)  
**Accessories to be ordered separately:**  
2 tips D10 for threaded rods M8 - ref. N. 990836  
Pins, tips and rod-guiding plates for D8 rods - ref. N. 990837  
Striking plate in zinc-plated steel - ref. N. 038020

Backset mm 25	<b>783380254C.9</b>	C	1	10	10
Backset mm 30	<b>783380304C.9</b>	C	1	10	10
Backset mm 35	<b>783380354C.9</b>	B	1	10	10

**KEYED-ALIKE (K.A.) VERSION IN GROUPS OF 10 PIECES.**

(Key blank code 020275)

Backset mm 25	<b>783380254C.9Y</b>	D	1	10	10
Backset mm 30	<b>783380304C.9Y</b>	D	1	10	10
Backset mm 35	<b>783380354C.9Y</b>	D	1	10	10

Backset mm 25 single coding 88001	<b>783380254C.9Y1</b>	D	1	10	10
Backset mm 30 single coding 88001	<b>783380304C.9Y1</b>	D	1	10	10
Backset mm 35 single coding 88001	<b>783380354C.9Y1</b>	B	1	10	10

Backset mm 25 single coding 88002	<b>783380254C.9Y2</b>	D	1	10	10
Backset mm 30 single coding 88002	<b>783380304C.9Y2</b>	D	1	10	10
Backset mm 35 single coding 88002	<b>783380354C.9Y2</b>	B	1	10	10

Backset mm 25 single coding 88003	<b>783380254C.9Y3</b>	D	1	10	10
Backset mm 30 single coding 88003	<b>783380304C.9Y3</b>	D	1	10	10
Backset mm 35 single coding 88003	<b>783380354C.9Y3</b>	C	1	10	10

Backset mm 25 single coding 88004	<b>783380254C.9Y4</b>	D	1	10	10
Backset mm 30 single coding 88004	<b>783380304C.9Y4</b>	D	1	10	10
Backset mm 35 single coding 88004	<b>783380354C.9Y4</b>	D	1	10	10

Backset mm 25 single coding 88005	<b>783380254C.9Y5</b>	D	1	10	10
Backset mm 30 single coding 88005	<b>783380304C.9Y5</b>	D	1	10	10
Backset mm 35 single coding 88005	<b>783380354C.9Y5</b>	D	1	10	10



Code

Status  
Single package

Min. ord.

**Locks for metal frames**

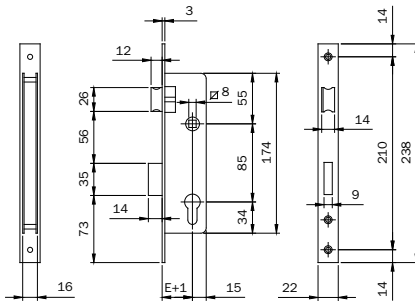

Open-case mortice lock for metal frames, operating with European profile cylinder.

Front plate mm **238 x 22 x 3** in STAINLESS STEEL. One 15 mm throw. **REVERSIBLE LATCHBOLT**.

Latchlocking by key or handle follower mm 8. Cylinder screw.

Backset mm 20	<b>741200</b>	B	1	10	10
Backset mm 25	<b>741250</b>	B	1	10	10
Backset mm 30	<b>741300</b>	B	1	10	10
Backset mm 35	<b>741350</b>	B	1	10	10

Open-case mortice lock for metal frames, operating with European profile cylinder.

Front plate mm **238 x 22 x 3** in CHROME-PLATED STEEL. One 15 mm throw. **REVERSIBLE LATCHBOLT**

Latchlocking by key or handle follower mm 8. Cylinder screw.

Backset mm 20	<b>741203</b>	B	1	10	10
Backset mm 25	<b>741253</b>	B	1	10	10
Backset mm 30	<b>741303</b>	B	1	10	10
Backset mm 35	<b>741353</b>	A	1	10	10

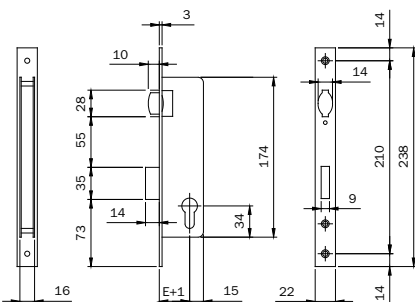

Open-case mortice lock for metal frames, operating with European profile cylinder. Front plate mm **238 x 22 x 3** in STAINLESS STEEL. One 15 mm throw. **ADJUSTABLE ROLLER**. Cylinder screw.

Backset mm 20	<b>743200</b>	D	1	10	10
Backset mm 25	<b>743250</b>	D	1	10	10
Backset mm 30	<b>743300</b>	D	1	10	10
Backset mm 35	<b>743350</b>	D	1	10	10

Open-case mortice lock for metal frames, operating with European profile cylinder. Front plate mm **238 x 22 x 3** in CHROME-PLATED STEEL. One 15 mm throw. **ADJUSTABLE ROLLER**. Cylinder screw.

Backset mm 20	<b>743203</b>	D	1	10	10
Backset mm 25	<b>743253</b>	D	1	10	10
Backset mm 30	<b>743303</b>	D	1	10	10
Backset mm 35	<b>743353</b>	C	1	10	10



Code

Min. ord.  
Multiple  
package  
Single  
package  
Status

## Locks for glass doors

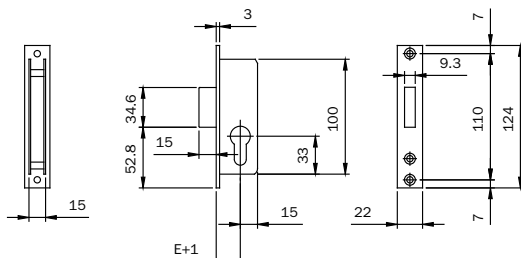

Mortice lock for **GLASS DOORS**, operating with European profile cylinder.  
Front plate mm **124 x 22 x 3** in NICKEL-PLATED STEEL. One 15 mm throw.  
Deadbolt flush with front plate. Cylinder screw.

**Accessories to be ordered separately:**

Striking plate in chrome-plated steel ref. n. 033094

Backset mm 20

**745203F** B 1 10 10

## Locks for metal frames

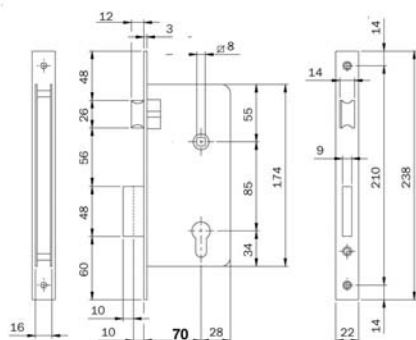

Open-case mortice lock for metal frames, operating with European profile cylinder.

Front plate mm **238 x 22 x 3** in CHROME-PLATED STEEL. Two 10 mm throws. **REVERSIBLE LATCHBOLT**

Latchlocking by key or handle follower mm 8. Cylinder screw.

**PACKED IN NYLON BAGS.**

**Accessories to be ordered separately:**

Striking plate in chrome-plated steel ref. N. 033083

Backset mm 70

**290703** B 1 25 25



Code

Min. ord.  
Multiple  
package  
Single  
package  
Status

**Locks for metal frames**

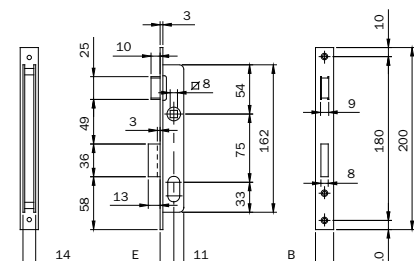

Open-case mortice lock for metal frames, operating with oval cylinder. One 9 mm throw.  
CHROME-PLATED STEEL front plate. DEADBOLT extended by 3 mm **SEPARATE LATCHBOLT** with latchlocking by handle follower mm 8. Backset mm 15. Cylinder screw.

**Accessories to be ordered separately:**

Striking plate in chrome-plated steel - ref. N. 033013 - ref. N. 033014

Front plate mm <b>200 x 16 x 3</b>	<b>7501510</b>	A	1	10	10
Front plate mm <b>200 x 20 x 3</b>	<b>7501520</b>	B	1	10	10

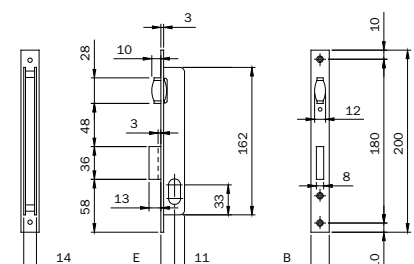

Open-case mortice lock for metal frames, operating with oval cylinder. One 9 mm throw.  
CHROME-PLATED STEEL FRONT PLATE. DEADBOLT extended by 3 mm **ADJUSTABLE ROLLER**. Backset mm 15. Cylinder screw.

**Accessories to be ordered separately:**

Striking plate in chrome-plated steel - ref. N. 033013 - ref. N. 033014

Front plate mm <b>200 x 16 x 3</b>	<b>7521510</b>	B	1	10	10
Front plate mm <b>200 x 20 x 3</b>	<b>7521520</b>	B	1	10	10

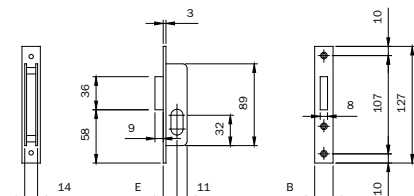

Open-case mortice lock for metal frames, operating with oval cylinder. One 9 mm throw.  
Front plate in CHROME-PLATED STEEL. **DEADBOLT FLUSH WITH FRONT PLATE**. Backset mm 15. Cylinder screw.

**Accessories to be ordered separately:**

Striking plate in chrome-plated steel - ref. N. 033013 - ref. N. 033014

Front plate mm <b>127 x 16 x 3</b>	<b>7581510</b>	B	1	10	10
Front plate mm <b>127 x 20 x 3</b>	<b>7581520</b>	B	1	10	10



Code

Min. ord.  
Multiple  
package  
Single  
package  
Status

**Locks for metal frames**

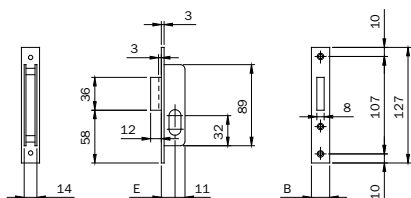

Open-case mortice lock for metal frames, operating with oval cylinder. One 9 mm throw.  
Front plate in CHROME-PLATED STEEL. DEADBOLT extended 3 mm. Backset mm 15. Cylinder screw.

**Accessories to be ordered separately:**

Striking plate in chrome-plated steel - ref. N. 033013 - ref. N. 033014

Front plate mm **127 x 16 x 3**

**7601510** A 1 10 10

Front plate mm **127 x 20 x 3**

**7601520** B 1 10 10

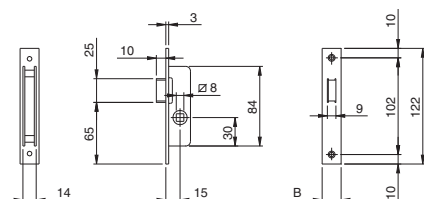

Open-case mortice lock for metal frames. CHROME-PLATED front plate.  
**LATCHLOCKING** by handle follower mm 8.

**Accessories to be ordered separately:**

Striking plate in chrome-plated steel - ref. N. 033013 - ref. N. 033014

Front plate mm **122 x 16 x 3**

**762001** A 1 10 10

Front plate mm **122 x 20 x 3**

**762002** B 1 10 10

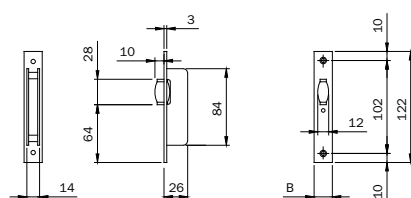

Open-case mortice lock for metal frames. CHROME-PLATED front plate.  
**ADJUSTABLE ROLLER.**

**Accessories to be ordered separately:**

Striking plate in chrome-plated steel - ref. N. 033013 - ref. N. 033014

Front plate mm **122 x 16 x 3**

**764001** A 1 10 10

Front plate mm **122 x 20 x 3**

**764002** A 1 10 10





Code

Min. ord.  
Multiple  
package  
Single  
package  
Status

**Locks for metal frames**

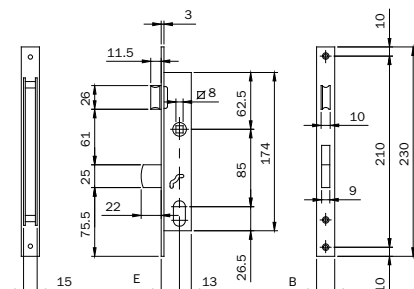

Open-case mortice lock for metal frames, operating with oval cylinder. 1 **BAYONET** throw 22 mm **SEPARATE LATCHBOLT** with latchlocking by handle follower mm 8. Backset mm 20. Cylinder screw.

**Accessories to be ordered separately:**

Chrome-plated striking plate - ref. N. 033091 - ref. N. 033092

Chrome-plated brass striking plate - ref. N. 033091.9 - ref. N. 033092.9

Front plate mm <b>230 x 16 x 3</b> in CHROME-PLATED STEEL	<b>7542010</b>	C	1	10	10
Front plate mm <b>230 x 16 x 3</b> in <b>CORROSION-RESISTANT</b> CHROME-PLATED BRASS	<b>75420109</b>	D	1	10	10
Front plate mm <b>230 x 20 x 3</b> in CHROME-PLATED STEEL	<b>7542020</b>	B	1	10	10
Front plate mm <b>230 x 20 x 3</b> in <b>CORROSION-RESISTANT</b> CHROME-PLATED BRASS	<b>75420209</b>	D	1	10	10

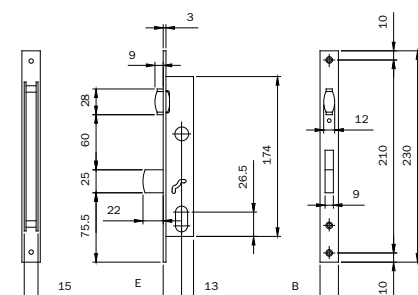

Open-case mortice lock for metal frames, operating with oval cylinder. 1 **BAYONET** throw 22 mm **ADJUSTABLE ROLLER**. Backset mm 20. Cylinder screw.

**Accessories to be ordered separately:**

Chrome-plated steel striking plate - ref. N. 033091 - ref. N. 033092

Chrome-plated brass striking plate - ref. N. 033091.9 - ref. N. 033092.9

Front plate mm <b>230 x 16 x 3</b> in CHROME-PLATED STEEL	<b>7562010</b>	D	1	10	10
Front plate mm <b>230 x 16 x 3</b> in <b>CORROSION-RESISTANT</b> CHROME-PLATED BRASS	<b>75620109</b>	D	1	10	10
Front plate mm <b>230 x 20 x 3</b> in CHROME-PLATED STEEL	<b>7562020</b>	C	1	10	10
Front plate mm <b>230 x 20 x 3</b> in <b>CORROSION-RESISTANT</b> CHROME-PLATED BRASS	<b>75620209</b>	D	1	10	10



Code

Min. ord.  
Multiple  
package  
Single  
package  
Status

**Locks for metal frames**

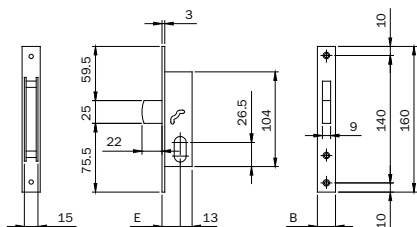

Open-case mortice lock for metal frames, operating with oval cylinder. 1 **BAYONET** throw 22 mm  
Backset mm 20. Cylinder screw.

**Accessories to be ordered separately:**

Chrome-plated steel striking plate - ref. N. 033091 - ref. N. 033092

Chrome-plated brass striking plate - ref. N. 033091.9 - ref. N. 033092.9

Front plate mm <b>230 x 16 x 3</b> in CHROME-PLATED STEEL	<b>7662010</b>	C	1	10	10
Front plate mm <b>230 x 16 x 3</b> in <b>CORROSION-RESISTANT</b> CHROME-PLATED BRASS	<b>76620109</b>	D	1	10	10
Front plate mm <b>230 x 20 x 3</b> in CHROME-PLATED STEEL	<b>7662020</b>	B	1	10	10
Front plate mm <b>230 x 20 x 3</b> in <b>CORROSION-RESISTANT</b> CHROME-PLATED BRASS	<b>76620209</b>	D	1	10	10

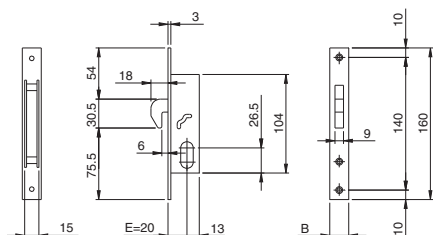

Open-case mortice lock for metal frames, operating with oval cylinder.  
1 throw, with **HOOK CLEARANCE 6**, 18 mm. Backset mm 20. Supplied with striking plate 033095 - 033095.9  
Cylinder screw

Front plate mm <b>160 x 16 x 3</b> in CHROME-PLATED STEEL	<b>7682010</b>	C	1	10	10
Front plate mm <b>160 x 20 x 3</b> in CHROME-PLATED STEEL	<b>7682020</b>	B	1	10	10
Front plate mm <b>160 x 20 x 3</b> in <b>CORROSION-RESISTANT</b> CHROME-PLATED BRASS	<b>76820209</b>	D	1	10	10

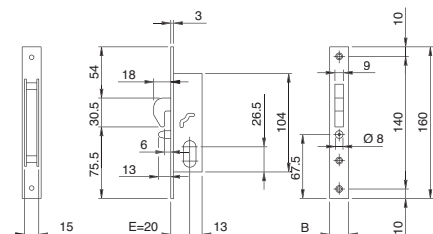

Open-case mortice lock for metal frames, with lift-proof pin, operating with oval cylinder. 1 throw, **HOOK WITH CLEARANCE 6**, 18 mm. Backset mm 20.  
Supplied with striking plate 033095 - 033095.9. Cylinder screw.

Front plate mm <b>160 x 16 x 3</b> in CHROME-PLATED STEEL	<b>7682110</b>	B	1	10	10
Front plate mm <b>160 x 20 x 3</b> in CHROME-PLATED STEEL	<b>7682120</b>	B	1	10	10
Front plate mm <b>160 x 20 x 3</b> in <b>CORROSION-RESISTANT</b> CHROME-PLATED BRASS	<b>76821209</b>	D	1	10	10





**Mortice locks  
for  
metal frames**

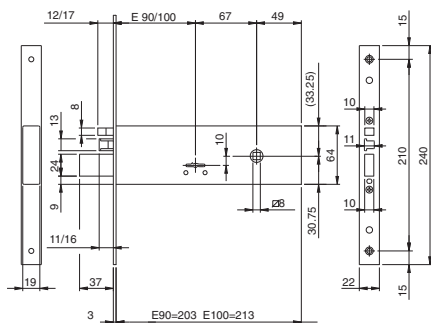
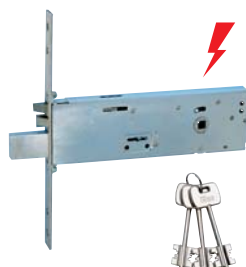

Code

Min. ord.  
Multiple  
package  
Single  
package  
Status**Electric mortice locks  
stainless steel front plate mm 22**

Double-bit electric mortice lock for metal frames. **12V A.C.-D.C.** LATERAL LOCKING. 3 KEYS **mm 100**.  
Front plate in STAINLESS STEEL **240 X 22 X 3**. Case height mm 64. Four mm 9 throws. **LATCHBOLT AND SEPARATE REVERSIBLE AND ADJUSTABLE LOADING SPRING**. 2 nylon key guides. Pair of front plate supports. Fixing screws.  
Instruction sheet (Key blank 990802).

**Accessories to be ordered separately:**

Striking plate

Backset mm 100	<b>961900102</b>	D	1	10	10
Backset mm 90	<b>961900902</b>	D	1	10	10

Double-bit electric mortice lock for metal frames. **12V A.C.-D.C.** LATERAL LOCKING. 3 KEYS **mm 79**.  
Front plate in STAINLESS STEEL **240 X 22 X 3**. Case height mm 64. Four mm 9 throws. **LATCHBOLT AND SEPARATE REVERSIBLE AND ADJUSTABLE** loading spring. 2 nylon key guides. Pair of front plate supports. Fixing screws.  
Instruction sheet (Key blank 990802).

**Accessories to be ordered separately:**

Striking plate

Backset mm 100	<b>961910102</b>	D	1	10	10
Backset mm 90	<b>961910902</b>	A	1	10	10



Code

Min. ord.  
Multiple  
package  
Single  
package  
Status

**Electric mortice locks  
stainless steel front plate mm 22**

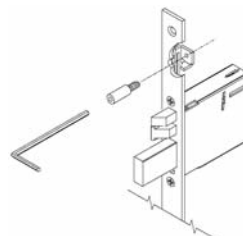
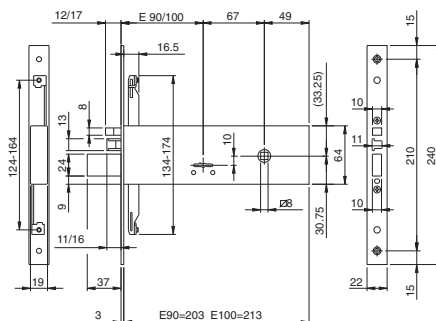
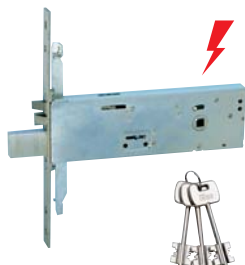

Double-bit electric mortice lock for metal frames. **12V A.C.-D.C.** 3-POINT LOCKING. Rods screwed connection.  
3 KEYS **mm 100**. Front plate in STAINLESS STEEL **240 X 22 X 3**. Case height mm 64. Four mm 9 throws.  
**SEPARATE REVERSIBLE AND ADJUSTABLE LATCHBOLT.** 2 nylon key-guides. Pair of front plate supports.  
Fixing screws. Instruction sheet (Key blank 990802).

**Accessories to be ordered separately:**

- Pair of plates to connect the lock to the external rods - ref. N. 990853
- Deviators for lateral 3-point locking, external rods - ref. N. 780322252
- Deviators for lateral 3-point locking, internal rods - ref. N. 780302252
- Pair of internal deviated rods with accessories - ref. N. 990850
- Pair of internal straight rods - ref. N. 990851

Striking plates

Backset mm 100	<b>963900102</b>	D	1	10	10
Backset mm 90	<b>963900902</b>	C	1	10	10

Double-bit electric mortice lock for metal frames. **12V A.C.-D.C.** 3-POINT LOCKING. Rods screwed connection.  
3 KEYS **mm 79**. Front plate in STAINLESS STEEL **240 X 22 X 3**. Case height mm 64. Four mm 9 throws.  
**SEPARATE REVERSIBLE AND ADJUSTABLE LATCHBOLT.** 2 nylon key-guides. Pair of front plate supports.  
Fixing screws. Instruction sheet (Key blank 990802).

**Accessories to be ordered separately:**

- Pair of plates to connect the lock to the external rods - ref. N. 990853
- Deviators for lateral 3-point locking, external rods - ref. N. 780322252
- Deviators for lateral 3-point locking, internal rods - ref. N. 780302252
- Pair of internal deviated rods with accessories - ref. N. 990850
- Pair of internal straight rods - ref. N. 990851

Striking plates

Backset mm 100	<b>963910102</b>	C	1	10	10
Backset mm 90	<b>963910902</b>	A	1	10	10



Code

Min. ord.  
Multiple  
package  
Single  
package  
Status

**Mortice locks  
stainless steel front plate mm 22**

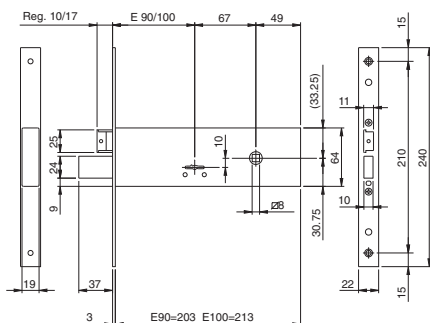

Double-bit mortice lock for metal frames. **MODULAR**. LATERAL LOCKING. 3 KEYS **mm 100**.

Front plate in STAINLESS STEEL **240 X 22 X 3**. Case height mm 64. Four mm 9 throws

**REVERSIBLE AND ADJUSTABLE LATCHBOLT.**

THE LATCHBOLT CAN BE REPLACED WITH THE ROLLER OR WITH THE CAP FOR ONLY DEADBOLT VERSIONS.

2 nylon key guides. Pair of front plate supports. Cylinder fixing screws. Fixing screws.

Instruction sheet (Key blank 990802).

**Accessories to be ordered separately:**

Modular roller - ref. N. 040820

Modular plug for deadbolt hole - ref. N. 040830

Striking plates

Backset mm 100

**961100102** D 1 10 10

Backset mm 90

**961100902** D 1 10 10

Double-bit mortice lock for metal frames. **MODULAR**. LATERAL LOCKING. 3 KEYS **mm 79**.

Front plate in STAINLESS STEEL **240 X 22 X 3**. Case height mm 64. Four mm 9 throws

**REVERSIBLE AND ADJUSTABLE LATCHBOLT.**

THE LATCHBOLT CAN BE REPLACED WITH THE ROLLER OR WITH THE CAP FOR ONLY DEADBOLT VERSIONS.

2 nylon key guides. Pair of front plate supports. Cylinder fixing screw. Fixing screws.

Instruction sheet (Key blank 990802).

**Accessories to be ordered separately:**

Modular roller - ref. N. 040820

Modular plug for deadbolt hole - ref. N. 040830

Striking plates

Backset mm 100

**961110102** C 1 10 10

Backset mm 90

**961110902** B 1 10 10



Code

Min. ord.  
Multiple package  
Single package  
Status

**Mortice locks stainless steel front plate mm 22**

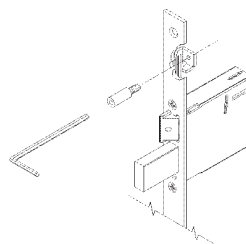
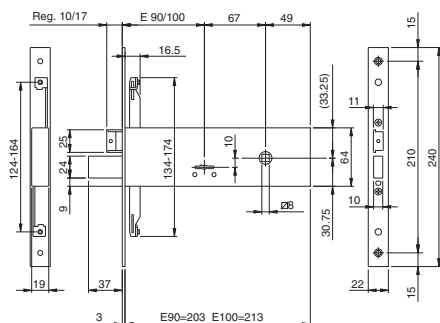

Double-bit mortice lock for metal frames. **MODULAR**. 3-POINT LOCKING. Rods screwed connections.

3 KEYS **mm 100**. Front plate in STAINLESS STEEL **240 X 22 X 3**. Case height mm 64. Four mm 9 trows

**REVERSIBLE AND ADJUSTABLE LATCHBOLT.**

THE LATCHBOLT CAN BE REPLACED WITH THE ROLLER OR WITH THE CAP FOR ONLY DEADBOLT VERSIONS.

2 nylon key guides. Pair of front plate supports. Cylinder fixing screw. Fixing screws. Instruction sheet (Key blank 990802).

**Accessories to be ordered separately:**

Modular roller - ref. N. 040820

Modular plug for deadbolt hole - ref. N. 040830

Pair of plates to connect the lock to the external rods - ref. N. 990853

Deviators for lateral 3-point locking, external rods - ref. N. 780322252

Deviators for lateral 3-point locking, internal rods - ref. N. 780302252

Pair of internal deviated rods with accessories - ref. N. 990850

Pair of internal straight rods - ref. N. 990851

Striking plates

Backset mm 100

**963100102** C 1 10 10

Backset mm 90

**963100902** B 1 10 10

Double-bit mortice lock for metal frames. **MODULAR**. 3-POINT LOCKING. Rods screwed connections.

3 KEYS **mm 79**. Front plate in STAINLESS STEEL **240 X 22 X 3**. Case height mm 64. Four mm 9 throws

**REVERSIBLE AND ADJUSTABLE LATCHBOLT.**

THE LATCHBOLT CAN BE REPLACED WITH THE ROLLER OR WITH THE CAP FOR ONLY DEADBOLT VERSIONS.

2 nylon key guides. Pair of front plate supports. Cylinder fixing screw. Fixing screws. Instruction sheet. (Key blank 990802).

**Accessories to be ordered separately:**

Modular roller - ref. N. 040820

Modular plug for deadbolt hole - ref. N. 040830

Pair of plates to connect the lock to the external rods - ref. N. 990853

Deviators for lateral 3-point locking, external rods - ref. N. 780322252

Deviators for lateral 3-point locking, internal rods - ref. N. 780302252

Pair of internal deviated rods with accessories - ref. N. 990850

Pair of internal straight rods - ref. N. 990851

Striking plates

Backset mm 100

**963110102** B 1 10 10

Backset mm 90

**963110902** A 1 10 10







Code

Min. ord.  
Multiple  
package  
Single  
package  
Status

**Mortice locks  
stainless steel front plate mm 22**

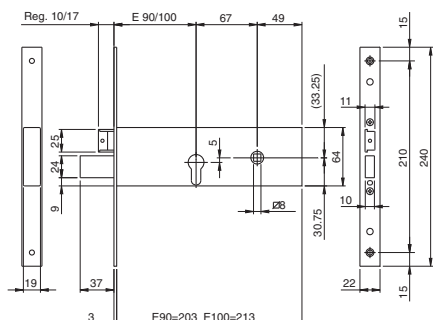
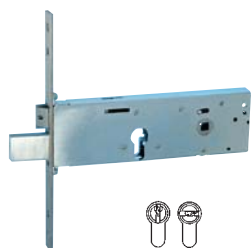

Double-bit mortice lock for metal frames. **MODULAR**. LATERAL LOCKING. Front plate in STAINLESS STEEL **240 X 22 X 3**. Case height mm 64. Three mm 12 throws. **SEPARATE REVERSIBLE AND ADJUSTABLE LATCHBOLT**. THE LATCHBOLT CAN BE REPLACED WITH THE ROLLER OR WITH THE CAP FOR ONLY DEADBOLT VERSIONS. 2 escutcheons. Pair of front plate supports. Cylinder fixing screw. Fixing screws. Instruction sheet. (Key blank 990802).

**Accessories to be ordered separately:**

- Modular roller - ref. N. 040820
- Modular plug for deadbolt hole - ref. N. 040830
- Striking plates

Backset mm 100	<b>961120102</b>	B	1	10	10
Backset mm 90	<b>961120902</b>	A	1	10	10

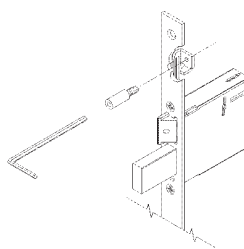
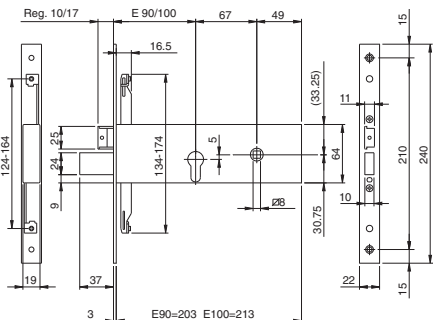
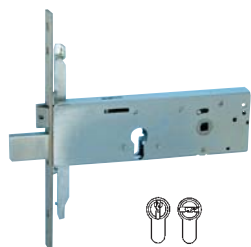

Double-bit mortice lock for metal frames. **MODULAR**. 3-POINT LOCKING. Rods screwed connections. Front plate in STAINLESS STEEL **240X22X3**. Case height mm 64. Three mm 12 throws. **SEPARATE REVERSIBLE AND ADJUSTABLE LATCHBOLT**. THE LATCHBOLT CAN BE REPLACED WITH THE ROLLER OR WITH THE CAP FOR ONLY DEADBOLT VERSIONS. 2 escutcheons. Pair of front plate supports. Internal cylinder fixing screw. Fixing screws. Instruction sheet. (Key blank 990802).

**Accessories to be ordered separately:**

- Modular roller - ref. N. 040820
- Modular plug for deadbolt hole - ref. N. 040830
- Pair of plates to connect the lock to the external rods - ref. N. 990853
- Deviators for lateral 3-point locking, external rods - ref. N. 780322252
- Deviators for lateral 3-point locking, internal rods - ref. N. 780302252
- Pair of internal deviated rods with accessories - ref. N. 990850
- Pair of internal straight rods - ref. N. 990851

Striking plates					
Backset mm 100	<b>963120102</b>	A	1	10	10
Backset mm 90	<b>963120902</b>	A	1	10	10



Code

Min. ord.  
Multiple  
package  
Single  
package  
Status

**Mortice locks  
stainless steel front plate mm 22**

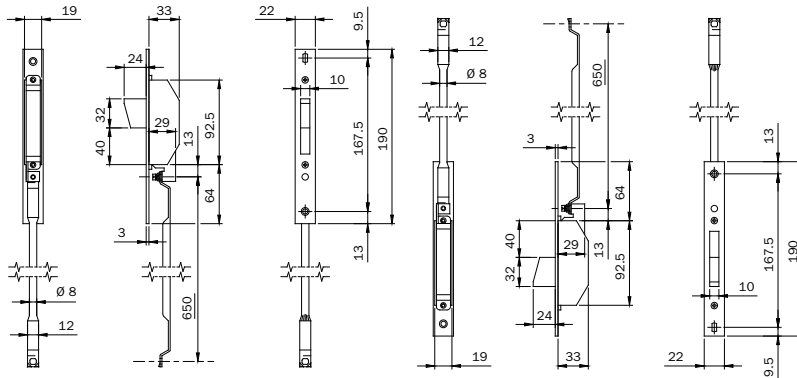

Deviators for 3-point lateral locking. Internal rods to be used with locks with screwed connection.  
Front plate mm **190 x 22 x 3** in STAINLESS STEEL. Rotating DEADBOLT with mm 24 throw.  
2 pairs of nylon spacers.  
Rod-guiding nylon bushes. Fixing screws.

**780302252** A 1 5 5

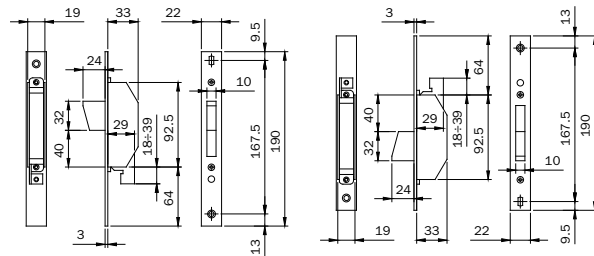

Deviators for 3-point lateral locking. For assembly with external to be used with locks with rods screwed connection.  
Front plate mm **190 x 22 x 3** in STAINLESS STEEL. Rotating DEADBOLT with mm 24 throw.  
2 pairs of nylon spacers.  
Rod-guiding nylon bushes. Fixing screws.

**780322252** B 1 5 5



Roller for double-bit **MODULAR** lock. With nylon insert for adjustable striking plates.  
Spring. Spring plate.

**040820** B 10 - 10



Plug for double-bit **MODULAR** lock. In nickel-plated zamak. To be assembled instead of the latchbolt for only deadbolt versions.

**040830** B 10 - 10



Code

Min. ord.  
Multiple  
package  
Single  
package  
Status

**Mortice locks  
zinc-plated front plate mm 24**

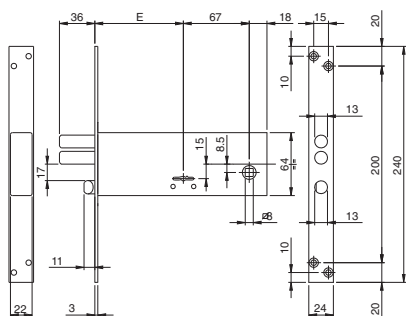

Double-bit mortice lock for metal frames. LATERAL LOCKING. 3 KEYS **mm 79**.

Front plate in zinc-plated steel **240 x 24 x 3**. Case height mm 64. Four throws, two loading springs D 13, mm 9.

**SEPARATE REVERSIBLE LATCHBOLT**. Deadlocking by key or handle follower mm 8.

2 escutcheons. Fixing screws. (Key blank 990800).

**Accessories to be ordered separately:**

Striking plates

Backset mm 70	<b>961701B4</b>	B	1	10	10
Backset mm 90	<b>961901B4</b>	C	1	10	10

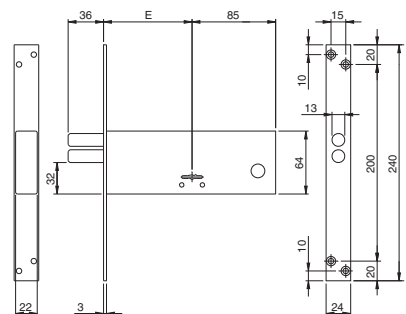

Double-bit mortice lock for metal frames. LATERAL LOCKING. 3 KEYS **mm 79**.

Front plate in zinc-plated steel **240 x 24 x 3**. Case height mm 64. Four throws, two loading springs D 13, mm 9.

2 escutcheons. Fixing screws. (Key blank 990800).

**Accessories to be ordered separately:**

Striking plates

Backset mm 70	<b>961703B4</b>	D	1	10	10
Backset mm 90	<b>961903B4</b>	D	1	10	10



Code

Min. ord.  
Multiple  
package  
Single  
package  
Status

**Mortice locks  
zinc-plated front plate mm 24**

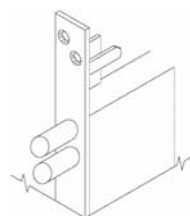
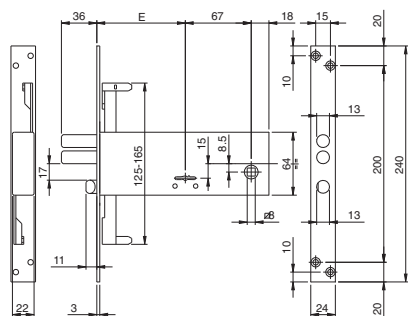

Double-bit mortice lock for metal frames. 3-POINT LOCKING. Rods clutch connections. 3 KEYS **mm 79**.  
Front plate in zinc-plated steel **240 x 24 x 3**. Case height mm 64. Four throws, two loading springs D 13, mm 9.  
**SEPARATE REVERSIBLE LATCHBOLT**. Latchlocking by key or handle follower mm 8.  
2 escutcheons. Fixing screws. (Key blank 990800).

**Accessories to be ordered separately:**

- Pair of internal deviated and slotted rods D8 - ref. N. 990810
- Pair of internal straight and slotted rods D8 - ref. N. 990811
- Screwed connection M8 for threaded rods - ref. N. 990823
- Pins, tips and rod-guiding plates for D8 rods - ref. N. 990837
- Striking plates
- Backset mm 70
- Backset mm 90

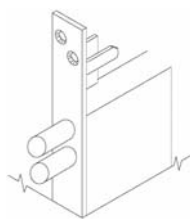

<b>963701B4</b>	B	1	10	10
<b>963901B4</b>	B	1	10	10



Double-bit mortice lock for metal frames. 3-POINT LOCKING. Rods clutch connections. 3 KEYS **mm 79**.  
Front plate in zinc-plated steel **240 x 24 x 3**. Case height mm 64. Four throws, two loading springs D 13, mm 9.  
2 escutcheons. Fixing screws. (Key blank 990800).

**Accessories to be ordered separately:**

- Pair of internal deviated and slotted rods D8 - ref. N. 990810
- Pair of internal straight and slotted rods D8 - ref. N. 990811
- Screwed connection M8 for threaded rods - ref. N. 990823
- Pins, tips and rod-guiding plates for D8 rods - ref. N. 990837
- Striking plates
- Backset mm 70
- Backset mm 90

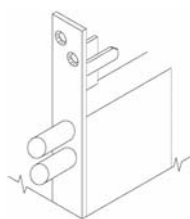

<b>963703B4</b>	C	1	10	10
<b>963903B4</b>	B	1	10	10

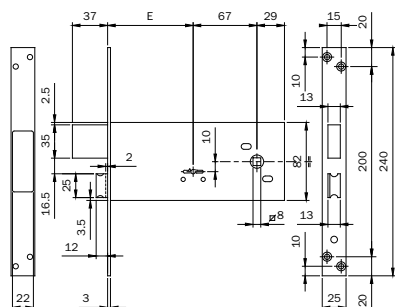

Double-bit mortice lock for metal frames. 3-POINT LOCKING. 3 KEYS **mm 79**. Backset 90 mm  
Front plate in zinc-plated steel **240 x 25 x 3**. Case height mm 82. Four mm 9 throws. **SEPARATE REVERSIBLE LATCHBOLT**. Latchlocking by key or handle follower mm 8. 2 escutcheons. Fixing screws.  
**PACKED IN INDIVIDUAL BOXES**. (Key blank 990800).

**Accessories to be ordered separately:**

- Striking plates
- Backset mm 90

<b>981901.FZ</b>	C	1	10	10
------------------	---	---	----	----



Code

Min. ord.  
Multiple  
package  
Single  
package  
Status

**Mortice locks  
zinc-plated front plate mm 25**

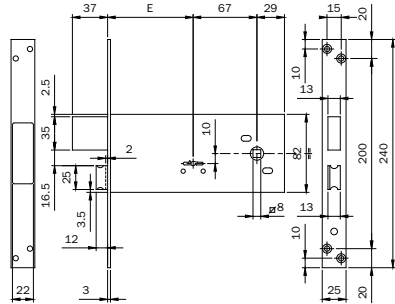

Double-bit mortice lock for metal frames. LATERAL LOCKING. 2 KEYS **mm 79**. Backset 90 mm  
Front plate in zinc-plated steel **240 x 25 x 3**. Case height mm 82. Four mm 9 throws. **SEPARATE REVERSIBLE LATCHBOLT**. Latchlocking by key or handle follower mm 8. 2 escutcheons. Fixing screws. **PACKED IN NYLON BAGS**. (Key blank 990800).

**Accessories to be ordered separately:**

Striking plates

Backset mm 90

**981901BFZ** A 1 10 10

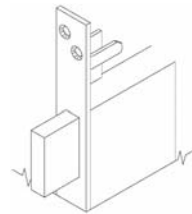
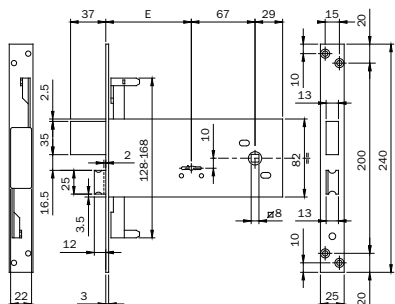

Double-bit mortice lock for metal frames. 3-POINT LOCKING. Rods clutch connection. 2 KEYS **mm 79**.  
Backset 90 mm Front plate in zinc-plated steel **240 x 25 x 3**. Case height mm 82. Four mm 9 throws. **SEPARATE REVERSIBLE LATCHBOLT**. Latchlocking by key or handle follower mm 8. 2 escutcheons. Fixing screws. **PACKED IN INDIVIDUAL BOXES**. (Key blank 990800).

**Accessories to be ordered separately:**

Striking plates

Backset mm 90

**983901.FZ** B 1 10 10

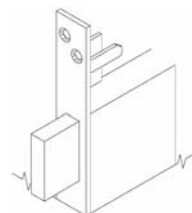
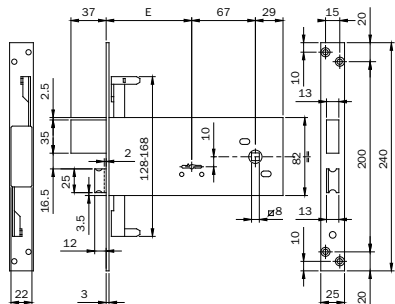

Double-bit mortice lock for metal frames. 3-POINT LOCKING. Rods clutch connection. 2 KEYS **mm 79**.  
Backset 90 mm Front plate in zinc-plated steel **240 x 25 x 3**. Case height mm 82. Four mm 9 throws. **SEPARATE REVERSIBLE LATCHBOLT**. Latchlocking by key or handle follower mm 8. 2 escutcheons. Fixing screws. **PACKED IN NYLON BAGS**. (Key blank 990800).

**Accessories to be ordered separately:**

Striking plates

Backset mm 90

**983901BFZ** A 1 10 10



Code

Min. ord.  
Multiple  
package  
Single  
package  
Status

**Mortice locks  
zinc-plated front plate mm 25**

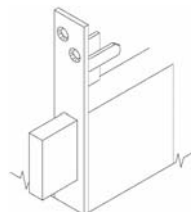
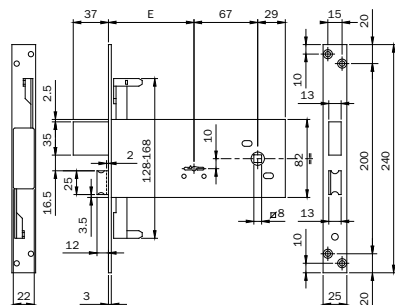

Double-bit mortice lock for metal frames. 3-POINT LOCKING. Supplied with M8 rods screwed connections. 2 KEYS **mm 79**.  
Backset 90 mm Front plate in zinc-plated steel **240 x 25 x 3**. Case height mm 82. Four mm 9 throws.  
**SEPARATE REVERSIBLE LATCHBOLT**. Latchlocking by key or handle follower mm 8. 2 escutcheons.  
2 escutcheons. Fixing screws. **PACKED IN NYLON BAGS**. (Key blank 990800)

**Accessories to be ordered separately:**

Striking plates

Backset mm 90

**983901BFZR** D 1 10 10

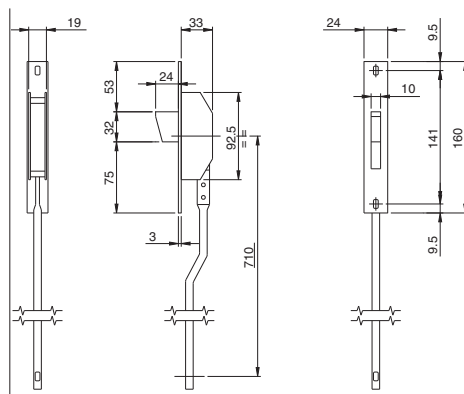

Deviators for 3-point lateral locking. Internal rods to be used with locks with clutch connection.  
Front plate mm **160 x 24 x 3** in STAINLESS STEEL. Rotating DEADBOLT mm 24 throw. Rod-guiding pins.  
Screws with roses. Instruction sheet.

**780253** B 1 5 5

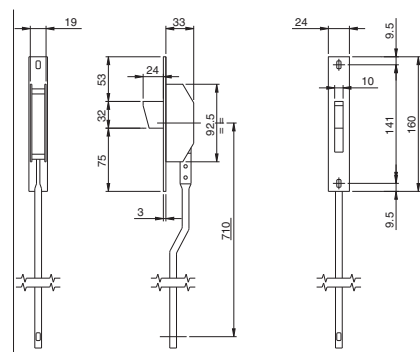

Deviators for 3-point lateral locking. Internal rods to be used with locks with clutch connection.  
Front plate mm **160 x 22 x 3** IN ZINC-PLATED STEEL. Rotating DEADBOLT with mm 24 throw.  
Rod-guiding pins. Screws with roses.

**780253BFZ** D 1 5 5



Code

Min. ord.  
Multiple  
package  
Single  
package  
Status

**Electric mortice locks  
zinc-plated front plate**

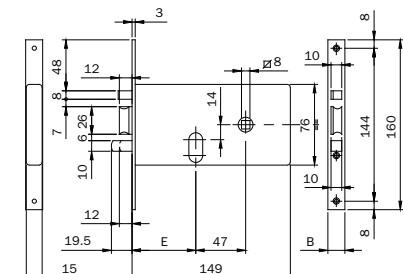
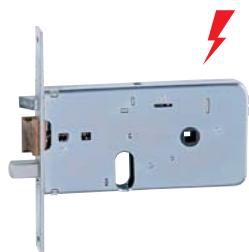

Zinc-plated electric mortice lock for metal frames operating with oval cylinder. **12V A.C.**

Case mm 76 center distance 47. Zinc-plated front plate **160 x 16 x 3**. Two throws.

**SELF-LOCKING LATCHBOLT WITH SEPARATE LOADING SPRING.**

Instruction sheet. Cylinder fixing screw.

Backset mm 60	<b>5506010</b>	A	1	10	10
Backset mm 70	<b>5507010</b>	A	1	10	10

Zinc-plated electric mortice lock for metal frames operating with oval cylinder. **12V A.C.**

Case mm 76 center distance 47. Zinc-plated front plate **160 x 20 x 3**. Two throws.

**SELF-LOCKING LATCHBOLT WITH SEPARATE LOADING SPRING.**

Instruction sheet. Cylinder fixing screw.

Backset mm 60	<b>5506020</b>	B	1	10	10
Backset mm 70	<b>5507020</b>	A	1	10	10

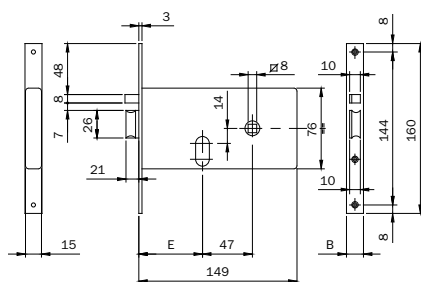

Zinc-plated electric mortice lock for metal frames operating with oval cylinder. **12V A.C.**

Case mm 76 center distance 47. Zinc-plated front plate **160 x 16 x 3**.

**SELF-LOCKING LATCHBOLT WITH SEPARATE LOADING SPRING.** Hold-open device.

Instruction sheet. Cylinder fixing screw.

Backset mm 60	<b>5516010</b>	C	1	10	10
Backset mm 70	<b>5517010</b>	C	1	10	10

Zinc-plated electric mortice lock for metal frames operating with oval cylinder. **12V A.C.**

Case mm 76 center distance 47. Zinc-plated front plate **160 x 20 x 3**.

**SELF-LOCKING LATCHBOLT WITH SEPARATE LOADING SPRING.** Hold-open device.

Instruction sheet. Cylinder fixing screw.

Backset mm 60	<b>5516020</b>	C	1	10	10
Backset mm 70	<b>5517020</b>	C	1	10	10





Code

Min. ord.  
Multiple  
package  
Single  
package  
Status

**Mortice locks zinc-plated front plate**

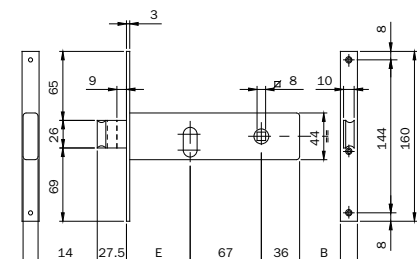

Lock for metal frames. LATERAL LOCKING. Operating with oval cylinder. Zinc-plated case H 44.

Zinc-plated front plate mm **160 x 16 x 3. DEADBOLT WITH mm 9 THROW WITH BUILT-IN LATCHBOLT.**

Latchlocking by key or handle follower mm 8. Cylinder fixing screw.

Backset mm 60 <b>one throw</b>	<b>7046010</b>	D	1	10	10
Backset mm 70 <b>two throws</b>	<b>7047010</b>	C	1	10	10
Backset mm 80 <b>two throws</b>	<b>7048010</b>	C	1	10	10

Lock for metal frames. LATERAL LOCKING. Operating with oval cylinder. Zinc-plated case H 44.

Zinc-plated front plate mm **160 x 16 x 3. DEADBOLT WITH mm 9 THROW WITH BUILT-IN LATCHBOLT.**

Latchlocking by key or handle follower mm 8. Cylinder fixing screw.

**PACKED IN NYLON BAGS.**

Backset mm 60 <b>one throw</b>	<b>704601S</b>	B	1	10	10
Backset mm 70 <b>two throws</b>	<b>704701S</b>	A	1	10	10
Backset mm 80 <b>two throws</b>	<b>704801S</b>	A	1	10	10

Lock for metal frames. LATERAL LOCKING. Operating with oval cylinder. Zinc-plated case H 44.

Zinc-plated front plate mm **160 X 20 X 3. DEADBOLT WITH mm 9 THROW WITH BUILT-IN LATCHBOLT.**

Latchlocking by key or handle follower mm 8. Cylinder fixing screw.

Backset mm 60 <b>one throw</b>	<b>7046020</b>	C	1	10	10
Backset mm 70 <b>two throws</b>	<b>7047020</b>	A	1	10	10
Backset mm 80 <b>two throws</b>	<b>7048020</b>	B	1	10	10

Lock for metal frames. LATERAL LOCKING. Operating with oval cylinder. Zinc-plated case H 44.

Zinc-plated front plate mm **160 x 20 x 3. DEADBOLT WITH mm 9 THROW WITH BUILT-IN LATCHBOLT.**

Latchlocking by key or handle follower mm 8. Cylinder fixing screw.

**PACKED IN NYLON BAGS.**

Backset mm 60 <b>one throw</b>	<b>704602S</b>	B	1	10	10
Backset mm 70 <b>two throws</b>	<b>704702S</b>	A	1	10	10
Backset mm 80 <b>two throws</b>	<b>704802S</b>	A	1	10	10

Lock for metal frames. LATERAL LOCKING. Operating with oval cylinder. Zinc-plated case H 44.

Zinc-plated front plate mm **160 x 14,7 x 3. DEADBOLT WITH mm 9 THROW WITH BUILT-IN LATCHBOLT.**

Latchlocking by key or handle follower mm 8. Cylinder fixing screw.

**PACKED IN NYLON BAGS.**

Backset mm 60 <b>one throw</b>	<b>704605S</b>	D	1	10	10
Backset mm 70 <b>two throws</b>	<b>704705S</b>	B	1	10	10
Backset mm 80 <b>two throws</b>	<b>704805S</b>	A	1	10	10



Code

Min. ord.  
Multiple  
package  
Single  
package  
Status

**Mortice locks zinc-plated front plate**

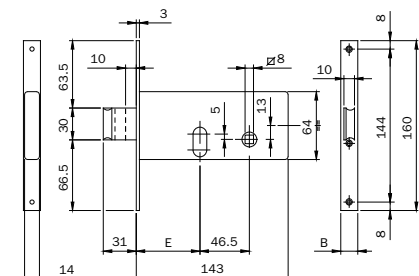

Lock for metal frames. LATERAL LOCKING. Operating with oval cylinder. Zinc-plated case H 64.  
Zinc-plated front plate mm **160 x 16 x 3. DEADBOLT WITH TWO THROWS MM 10 WITH BUILT-IN LATCHBOLT.**  
Latchlocking by key or handle follower mm 8. Cylinder fixing screw.  
Backset mm 60 **7106010** A 1 10 10  
Backset mm 70 **7107010** C 1 10 10

Lock for metal frames. LATERAL LOCKING. Operating with oval cylinder. Zinc-plated case H 64.  
Zinc-plated front plate mm **160 x 20 x 3. DEADBOLT WITH TWO THROWS mm 10 WITH BUILT-IN LATCHBOLT.**  
Latchlocking by key or handle follower mm 8. Cylinder fixing screw.  
Backset mm 60 **7106020** B 1 10 10  
Backset mm 70 **7107020** B 1 10 10



Key blank  
020159

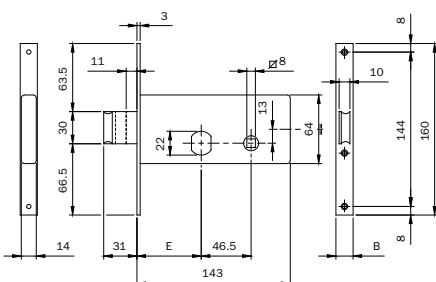

Lock for metal frames. LATERAL LOCKING. Operating with **MULTI-FACETED ROUND CYLINDER D 22**  
(840027277) supplied with the lock. 3 KEYS. Zinc-plated case H 64 . Zinc-plated front plate mm **160 x 16 x 3.**  
**DEADBOLT WITH TWO THROWS mm 10 WITH BUILT-IN LATCHBOLT.** Latchlocking by key or handle follower mm 8.  
2 nylon escutcheons. Cylinder fixing screw. (Key blank ref. N. 020159)  
Backset mm 60 **712601** A 1 10 10  
Backset mm 70 **712701** B 1 10 10

Lock for metal frames. LATERAL LOCKING. Operating with **MULTI-FACETED ROUND CYLINDER D 22**  
(840027277) supplied with the lock. 3 keys. Zinc-plated case H 64 . Zinc-plated front plate mm **160 x 20 x 3.**  
**DEADBOLT WITH TWO THROWS mm 10 WITH BUILT-IN LATCHBOLT.** Latchlocking by key or handle follower mm 8.  
2 nylon escutcheons. Cylinder fixing screw. (Key blank ref. N. 020159)  
Backset mm 60 **712602** A 1 10 10  
Backset mm 70 **712702** A 1 10 10



Code

Min. ord.  
Multiple  
package  
Single  
package  
Status

**Mortice locks zinc-plated front plate**



Key blank  
020159

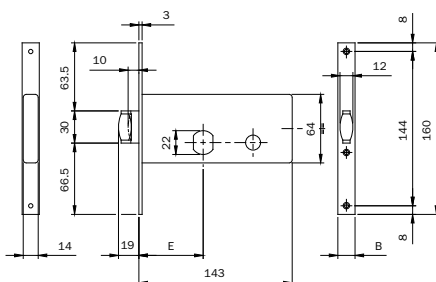

Lock for metal frames. LATERAL LOCKING. Operating with **MULTI-FACETED ROUND CYLINDER D 22** (840027277) supplied with the lock. 3 KEYS. Zinc-plated case H 64. Zinc-plated front plate mm **160 x 16 x 3**. One throw mm 10 with built-in adjustable roller. 2 nylon escutcheons. Cylinder fixing screw. (Key blank ref. N. 020159)

Backset mm 60	<b>713601</b>	D	1	10	10
Backset mm 70	<b>713602</b>	D	1	10	10



Key blank  
020159

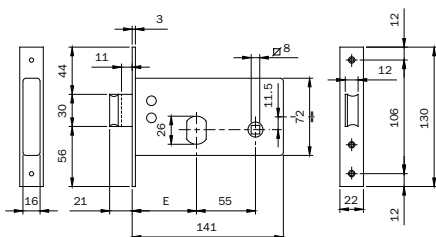

Lock for metal frames. LATERAL LOCKING. Operating with **MULTI-FACETED ROUND CYLINDER D 26** (842028287) supplied with the lock. 3 keys. Zinc-plated case H 72. Zinc-plated front plate mm **130 x 22 x 3** **DEADBOLT WITH THROW mm 11 WITH BUILT-IN LATCHBOLT**. Backset mm 60. 2 escutcheons.

Cylinder fixing screw. (Key blank ref. N. 020259)	<b>725600</b>	A	1	10	10
---	---------------	---	---	----	----

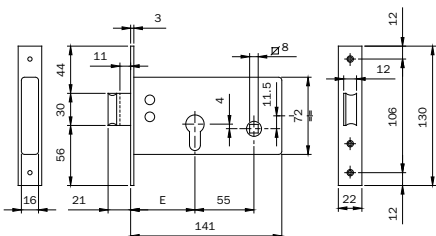

Lock for metal frames. LATERAL LOCKING. Operating with European-profile cylinder. Zinc-plated case H 72.

Zinc-plated front plate mm **130 x 22 x 3**. **DEADBOLT WITH THROW mm 11 WITH BUILT-IN LATCHBOLT**.

Latchlocking by key or handle follower mm 8. Backset mm 60. Cylinder fixing screw.	<b>720600</b>	A	1	10	10
--	---------------	---	---	----	----



**Locks for  
gates  
and shutters**



Code

Min. ord.  
Multiple  
package  
Single  
package  
Status

**2001 electric rim locks for gates**

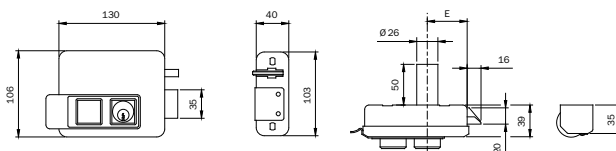

Key blank  
020259

**RIGHT-HAND** electric rim lock in STAINLESS STEEL. **12V-15W A.C.** Internal cylinder and external fixed cylinder D 26 x 50. Self-locking latchbolt. Separate loading spring with adjustable force. 3 KEYS. Adjustable keep. Escutcheon. Instruction sheet. (Key blank ref. N. 020259).

**Accessories to be ordered separately:**

Lock plate and keep plate - ref. N. 052012

Backset mm 60	<b>520010602</b>	B	1	6	6
Backset mm 70	<b>520010702</b>	B	1	6	6
Backset mm 80	<b>520010802</b>	A	1	6	6

**LEFT-HAND** electric rim lock in STAINLESS STEEL. **12V-15W A.C.** Internal cylinder and external fixed cylinder D 26 x 50. Self-locking latchbolt. Separate loading spring with adjustable force. 3 KEYS. Adjustable keep. Escutcheon. Instruction sheet. (Key blank ref. N. 020259).

**Accessories to be ordered separately:**

Lock plate and keep plate - ref. N. 052012

Backset mm 60	<b>520020602</b>	B	1	6	6
Backset mm 70	<b>520020702</b>	B	1	6	6
Backset mm 80	<b>520020802</b>	A	1	6	6

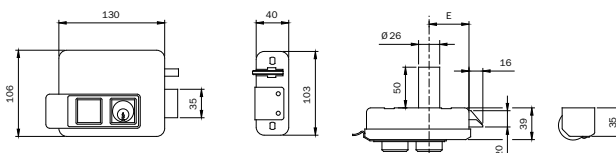

Key blank  
020259

**RIGHT-HAND** electric rim lock in STAINLESS STEEL. **12V-15W A.C.** Internal pushbutton, internal cylinder for **PUSHBUTTON LOCKING** or for **HOLD-OPEN** function, external fixed cylinder D 26 x 50. Self-locking latchbolt. Separate loading spring with adjustable force. 3 keys. Adjustable keep. Escutcheon. Instruction sheet. (Key blank ref. N. 020259).

**Accessories to be ordered separately:**

Lock plate and keep plate - ref. N. 052012

Backset mm 60	<b>520310602</b>	C	1	6	6
Backset mm 70	<b>520310702</b>	D	1	6	6
Backset mm 80	<b>520310802</b>	D	1	6	6

**LEFT-HAND** electric rim lock in STAINLESS STEEL. **12V-15W A.C.** Internal pushbutton, internal cylinder for **PUSHBUTTON LOCKING** or for **HOLD-OPEN** function, external fixed cylinder D 26 x 50. Self-locking latchbolt. Separate loading spring with adjustable force. 3 KEYS. Adjustable keep. Escutcheon. Instruction sheet. (Key blank ref. N. 020259).

**Accessories to be ordered separately:**

Lock plate and keep plate - ref. N. 052012

Backset mm 60	<b>520320602</b>	C	1	6	6
Backset mm 70	<b>520320702</b>	D	1	6	6
Backset mm 80	<b>520320802</b>	D	1	6	6



Code

Min. ord.  
Multiple  
package  
Single  
package  
Status

**2001 electric rim locks for gates**

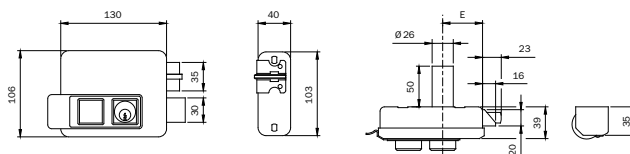

Key blank  
020259

**RIGHT-HAND** electric rim lock in STAINLESS STEEL. **12V-15W A.C.** Internal cylinder and external fixed cylinder D 26 x 50. 2 throws. Self-locking latchbolt. Separate loading spring with adjustable force. 3 KEYS. Adjustable keep. Escutcheon. Instruction sheet. (Key blank ref. N. 020259).

**Accessories to be ordered separately:**

Lock plate and keep plate - ref. N.. 052012

Backset mm 60	<b>530010602</b>	D	1	6	6
Backset mm 70	<b>530010702</b>	D	1	6	6
Backset mm 80	<b>530010802</b>	D	1	6	6

**LEFT-HAND** electric rim lock in STAINLESS STEEL. **12V-15W A.C.** Internal cylinder and external fixed cylinder D 26 x 50. 2 throws. Self-locking latchbolt. Separate loading spring with adjustable force. 3 KEYS. Adjustable keep. Escutcheon. Instruction sheet. (Key blank ref. N. 020259).

**Accessories to be ordered separately:**

Lock plate and keep plate - ref. N. 052012

Backset mm 60	<b>530020602</b>	D	1	6	6
Backset mm 70	<b>530020702</b>	D	1	6	6
Backset mm 80	<b>530020802</b>	D	1	6	6

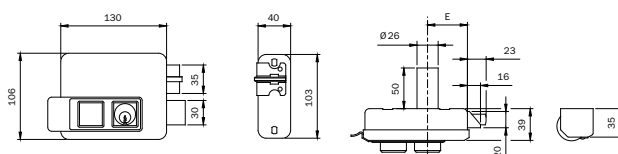

Key blank  
020259

**RIGHT-HAND** electric rim lock in STAINLESS STEEL. **12V-15W A.C.** Internal pushbutton. 2 throws operated by internal cylinder and fixed external cylinder D 26 x 50. Self-locking latchbolt with built-in loading spring with adjustable force. 3 KEYS. Adjustable keep. Escutcheon. Instruction sheet. (Key blank ref. N. 020259).

**Accessories to be ordered separately:**

Lock plate and keep plate - ref. N. 052012

Backset mm 60	<b>530210602</b>	D	1	6	6
Backset mm 70	<b>530210702</b>	D	1	6	6
Backset mm 80	<b>530210802</b>	D	1	6	6

**LEFT-HAND** electric rim lock in STAINLESS STEEL. **12V-15W A.C.** Internal pushbutton. 2 throws operated by internal cylinder and fixed external cylinder D 26 x 50. Self-locking latchbolt with built-in loading spring with adjustable force. 3 KEYS. Adjustable keep. Escutcheon. Instruction sheet. (Key blank ref. N. 020259).

**Accessories to be ordered separately:**

Lock plate and keep plate - ref. N. 052012

Backset mm 60	<b>530220602</b>	D	1	6	6
Backset mm 70	<b>530220702</b>	D	1	6	6
Backset mm 80	<b>530220802</b>	D	1	6	6



Code

Min. ord.  
Multiple package  
Single package  
Status

**2001 electric rim locks for gates**



Key blank 020259

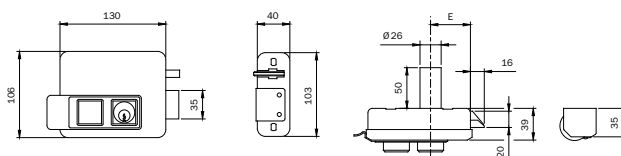

**RIGHT-HAND** electric rim lock, painted. **12V-15W A.C.** Internal cylinder and external fixed cylinder D 26 x 50. Self-locking latchbolt. Separate loading spring with adjustable force. 3 KEYS. Adjustable keep. Escutcheon. Instruction sheet. (Key blank ref. N. 020259).

**Accessories to be ordered separately:**

Lock plate and keep plate - ref. N. 052012

Backset mm 50	<b>520010505</b>	D	1	6	6
Backset mm 60	<b>520010605</b>	B	1	6	6
Backset mm 70	<b>520010705</b>	D	1	6	6
Backset mm 80	<b>520010805</b>	C	1	6	6



Key blank 020259

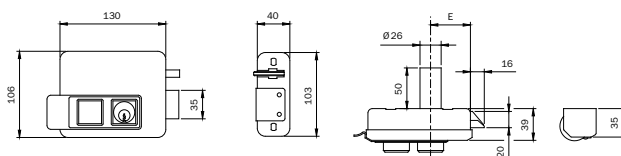

**LEFT-HAND** electric rim lock, painted. **12V-15W A.C.** Internal cylinder and external fixed cylinder D 26 x 50. Self-locking latchbolt. Separate loading spring with adjustable force. 3 KEYS. Adjustable keep. Escutcheon. Instruction sheet. (Key blank ref. N. 020259).

**Accessories to be ordered separately:**

Lock plate and keep plate - ref. N. 050012

Backset mm 50	<b>520110505</b>	C	1	6	6
Backset mm 60	<b>520110605</b>	B	1	6	6
Backset mm 70	<b>520110705</b>	C	1	6	6
Backset mm 80	<b>520110805</b>	C	1	6	6

**RIGHT-HAND** electric rim lock, painted. **12V-15W A.C.** Internal pushbutton and external fixed cylinder D 26 x 50. Self-locking latchbolt. Separate loading spring with adjustable force. 3 KEYS. Adjustable keep. Escutcheon. Instruction sheet. (Key blank ref. N. 020259).

**Accessories to be ordered separately:**

Lock plate and keep plate - ref. N. 050012

Backset mm 50	<b>520120505</b>	C	1	6	6
Backset mm 60	<b>520120605</b>	B	1	6	6
Backset mm 70	<b>520120705</b>	C	1	6	6
Backset mm 80	<b>520120805</b>	C	1	6	6



Code

Min. ord.  
Multiple  
package  
Single  
package  
Status

**2001 electric rim locks for gates**

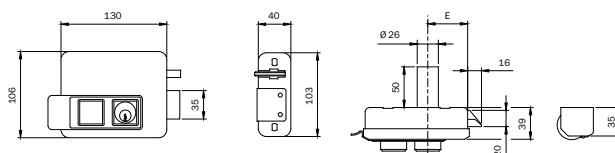

Key blank  
020259

**RIGHT-HAND** electric rim lock, painted. **12V-15W A.C.** Internal pushbutton, internal cylinder for pushbutton locking or for hold-open function, external fixed cylinder D 26 x 50. Self-locking latchbolt. Separate loading spring with adjustable force. 3 keys. Adjustable keep. Escutcheon. Instruction sheet. (Key blank ref. N. 020259).

**Accessories to be ordered separately:**

Lock plate and keep plate - ref. N. 052012

Backset mm 50	<b>520310505</b>	C	1	6	6
Backset mm 60	<b>520310605</b>	A	1	6	6
Backset mm 70	<b>520310705</b>	B	1	6	6
Backset mm 80	<b>520310805</b>	D	1	6	6

**LEFT-HAND** electric rim lock, painted. **12V-15W A.C.** Internal pushbutton, internal cylinder for pushbutton locking or for **HOLD-OPEN** function, external fixed cylinder D 26 x 50. Self-locking latchbolt. Separate loading spring with adjustable force. 3 KEYS. Adjustable keep. Escutcheon. Instruction sheet. (Key blank ref. N. 020259).

**Accessories to be ordered separately:**

Lock plate and keep plate - ref. N. 052012

Backset mm 50	<b>520320505</b>	C	1	6	6
Backset mm 60	<b>520320605</b>	A	1	6	6
Backset mm 70	<b>520320705</b>	D	1	6	6
Backset mm 80	<b>520320805</b>	D	1	6	6

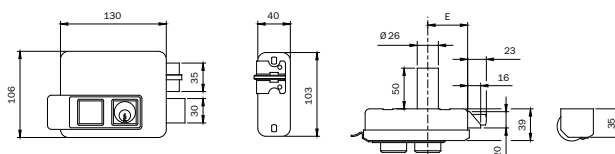

Key blank  
020259

**RIGHT-HAND** electric rim lock, painted. **12V-15W A.C.** Internal cylinder and external fixed cylinder D 26 x 50. 2 throws. Self-locking latchbolt. Built-in loading spring with adjustable force. 3 KEYS. Adjustable keep. Escutcheon. Instruction sheet. (Key blank ref. N. 020259).

**Accessories to be ordered separately:**

Lock plate and keep plate - ref. N. 050012

Backset mm 50	<b>530010505</b>	D	1	6	6
Backset mm 60	<b>530010605</b>	D	1	6	6
Backset mm 70	<b>530010705</b>	D	1	6	6
Backset mm 80	<b>530010805</b>	D	1	6	6

**LEFT-HAND** electric rim lock, painted. **12V-15W A.C.** Internal cylinder and external fixed cylinder D 26 x 50. 2 throws. Self-locking latchbolt. Built-in loading spring with adjustable force. 3 KEYS. Adjustable keep. Escutcheon. Instruction sheet. (Key blank ref. N. 020259).

**Accessories to be ordered separately:**

Lock plate and keep plate - ref. N. 050012

Backset mm 50	<b>530020505</b>	D	1	6	6
Backset mm 60	<b>530020605</b>	D	1	6	6
Backset mm 70	<b>530020705</b>	D	1	6	6
Backset mm 80	<b>530020805</b>	D	1	6	6





Code

Min. ord.  
Multiple package  
Single package  
Status

**2001 electric rim locks for gates**



Key blank  
020259

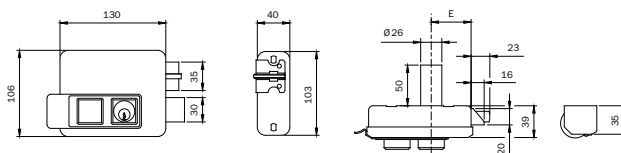

**RIGHT-HAND** electric rim lock, painted. **12V-15W A.C.** Internal pushbutton. 2 throws operated by internal cylinder and fixed external cylinder D 26 x 50. Self-locking latchbolt with built-in loading spring with adjustable force. 3 KEYS. Adjustable keep. Escutcheon. Instruction sheet. (Key blank ref. N. 020259).

**Accessories to be ordered separately:**

Lock plate and keep plate - ref. N. 050012

Backset mm 50	<b>530210505</b>	D	1	6	6
Backset mm 60	<b>530210605</b>	A	1	6	6
Backset mm 70	<b>530210705</b>	A	1	6	6
Backset mm 80	<b>530210805</b>	D	1	6	6

**LEFT-HAND** electric rim lock, painted. **12V-15W A.C.** Internal pushbutton. 2 throws operated by internal cylinder and fixed external cylinder D 26 x 50. Self-locking latchbolt with built-in loading spring with adjustable force. 3 KEYS. Adjustable keep. Escutcheon. Instruction sheet. (Key blank ref. N. 020259).

**Accessories to be ordered separately:**

Lock plate and keep plate - ref. N. 050012

Backset mm 50	<b>530220505</b>	D	1	6	6
Backset mm 60	<b>530220605</b>	D	1	6	6
Backset mm 70	<b>530220705</b>	D	1	6	6
Backset mm 80	<b>530220805</b>	D	1	6	6



Key blank  
020259

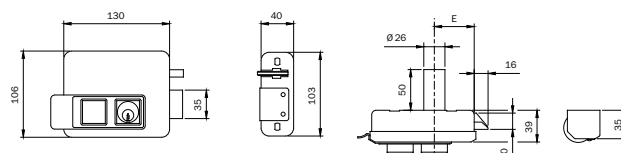

**RIGHT-HAND** electric rim lock, painted. **12V-15W A.C.** Internal cylinder and external fixed cylinder D 26 x 50. Self-locking latchbolt. Separate loading spring with adjustable force. 3 KEYS. Adjustable keep. Escutcheon. Instruction sheet. **Supplied with protective backplate and keep plate.** (Key blank ref. N. 020259)

Backset mm 50	<b>525010505</b>	B	1	10	10
Backset mm 60	<b>525010605</b>	A	1	10	10
Backset mm 70	<b>525010705</b>	A	1	10	10
Backset mm 80	<b>525010805</b>	A	1	10	10

**LEFT-HAND** electric rim lock, painted. **12V-15W A.C.** Internal cylinder and external fixed cylinder D 26 x 50. Self-locking latchbolt. Separate loading spring with adjustable force. 3 KEYS. Adjustable keep. Escutcheon. Instruction sheet. **Supplied with protective backplate and keep plate.** (Key blank ref. N. 020259)

Backset mm 50	<b>525020505</b>	B	1	6	6
Backset mm 60	<b>525020605</b>	A	1	6	6
Backset mm 70	<b>525020705</b>	A	1	6	6
Backset mm 80	<b>525020805</b>	A	1	6	6



Code

Min. ord.  
Multiple  
package  
Single  
package  
Status

**2001 electric rim locks for gates**



Key blank  
020259

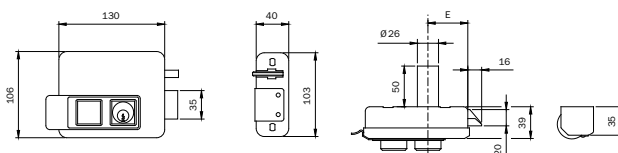

**LEFT-HAND** electric rim lock, painted. **12V-15W A.C.** Internal pushbutton, internal cylinder for **PUSHBUTTON LOCKING** or for **HOLD-OPEN** function, external fixed cylinder D 26 x 50. Self-locking latchbolt. Separate loading spring with adjustable force. 3 KEYS. Adjustable keep. Escutcheon. Instruction sheet.

**Supplied with protective backplate and keep plate.**

(Key blank ref. N. 020259)

Backset mm 50	<b>525310505</b>	B	1	10	10
Backset mm 60	<b>525310605</b>	A	1	10	10
Backset mm 70	<b>525310705</b>	A	1	10	10
Backset mm 80	<b>525310805</b>	B	1	10	10

**LEFT-HAND** electric rim lock, painted. **12V-15W A.C.** Internal pushbutton, internal cylinder for **PUSHBUTTON LOCKING** or for **HOLD-OPEN** function, external fixed cylinder D 26 x 50. Self-locking latchbolt. Separate loading spring with adjustable force. 3 KEYS. Adjustable keep. Escutcheon. Instruction sheet.

**Supplied with protective backplate and keep plate.**

(Key blank ref. N. 020259)

Backset mm 50	<b>525320505</b>	C	1	6	6
Backset mm 60	<b>525320605</b>	A	1	6	6
Backset mm 70	<b>525320705</b>	A	1	6	6
Backset mm 80	<b>525320805</b>	B	1	6	6



Key blank  
020259

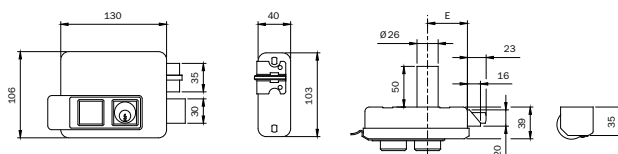

**RIGHT-HAND** electric rim lock, painted. **12V-15W A.C.** Internal cylinder and external fixed cylinder D 26 x 50. 2 throws. Self-locking latchbolt. Built-in loading spring with adjustable force. 3 KEYS. Adjustable keep. Escutcheon. Instruction sheet. (Key blank ref. N. 020259).

**Supplied with protective backplate and keep plate.**

Backset mm 50	<b>535010505</b>	B	1	10	10
Backset mm 60	<b>535010605</b>	A	1	10	10
Backset mm 70	<b>535010705</b>	A	1	10	10
Backset mm 80	<b>535010805</b>	B	1	10	10

**LEFT-HAND** electric rim lock, painted. **12V-15W A.C.** Internal cylinder and external fixed cylinder D 26 x 50. 2 throws. Self-locking latchbolt. Built-in loading spring with adjustable force. 3 KEYS. Adjustable keep. Escutcheon. Instruction sheet. (Key blank ref. N. 020259).

**Supplied with protective backplate and keep plate.**

Backset mm 50	<b>535020505</b>	C	1	6	6
Backset mm 60	<b>535020605</b>	A	1	6	6
Backset mm 70	<b>535020705</b>	A	1	6	6
Backset mm 80	<b>535020805</b>	C	1	6	6



Code

Min. ord.  
Multiple package  
Single package  
Status

**2001 electric rim locks for gates**

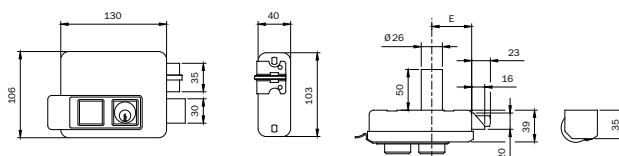

Key blank  
020259

**RIGHT-HAND** electric rim lock, painted. **12V-15W A.C.** Internal pushbutton. 2 throws operated by internal cylinder and fixed external cylinder D 26 x 50. Self-locking latchbolt with built-in loading spring with adjustable force. 3 KEYS. Adjustable keep. Escutcheon. Instruction sheet. (Key blank ref. N. 020259).

**Supplied with protective backplate and keep plate.**

Backset mm 50	<b>535210505</b>	D	1	10	10
Backset mm 60	<b>535210605</b>	A	1	10	10
Backset mm 70	<b>535210705</b>	A	1	10	10
Backset mm 80	<b>535210805</b>	C	1	10	10

**LEFT-HAND** electric rim lock, painted. **12V-15W A.C.** Internal pushbutton. 2 throws operated by internal cylinder and fixed external cylinder D 26 x 50. Self-locking latchbolt with built-in loading spring with adjustable force. 3 KEYS. Adjustable keep. Escutcheon. Instruction sheet. (Key blank ref. N. 020259).

**Supplied with protective backplate and keep plate.**

Backset mm 50	<b>535220505</b>	D	1	6	6
Backset mm 60	<b>535220605</b>	B	1	6	6
Backset mm 70	<b>535220705</b>	A	1	6	6
Backset mm 80	<b>535220805</b>	D	1	6	6

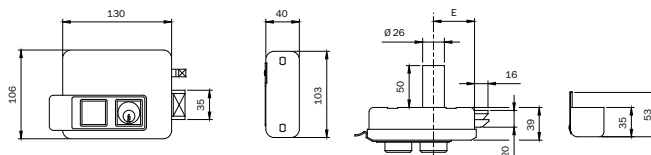

Key blank  
020259

**OUTSIDE OPENING**

**\*RIGHT-HAND** electric rim lock, painted, for gates for external opening. **12V-15W A.C.**

Internal cylinder and external fixed cylinder D 26 x 50. Self-locking latchbolt. Separate loading spring with adjustable force. 3 KEYS. Keep with nylon support and STAINLESS STEEL fixing plate. Escutcheon. Instruction sheet. Fixing screws. (Key blank ref. N. 020259)

Backset mm 50	<b>510010505</b>	D	1	6	6
Backset mm 60	<b>510010605</b>	B	1	6	6
Backset mm 70	<b>510010705</b>	B	1	6	6
Backset mm 80	<b>510010805</b>	D	1	6	6

**\*LEFT-HAND** electric rim lock, painted, for gates for external opening. **12V-15W A.C.**

Internal cylinder and external fixed cylinder D 26 x 50. Self-locking latchbolt. Separate loading spring with adjustable force. 3 KEYS. Keep with nylon support and STAINLESS STEEL fixing plate. Escutcheon. Instruction sheet. Fixing screws. (Key blank ref. N. 020259)

Backset mm 50	<b>510020505</b>	D	1	6	6
Backset mm 60	<b>510020605</b>	B	1	6	6
Backset mm 70	<b>510020705</b>	B	1	6	6
Backset mm 80	<b>510020805</b>	D	1	6	6

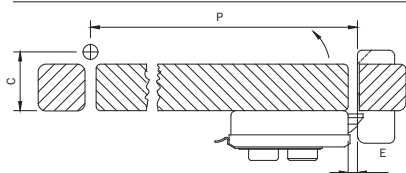

**\*INSTALLATION CONDITIONS FOR OUTSIDE OPENING**

- Dimension C: distance between the centres of the hinge and of the internal door edge max 80 mm
- Dimension P: door width min 900 mm
- Dimension E: distance between the lock and the keep max 9 mm



Code

Min. ord.  
Multiple  
package  
Single  
package  
Status

**2001 electric rim locks for gates**

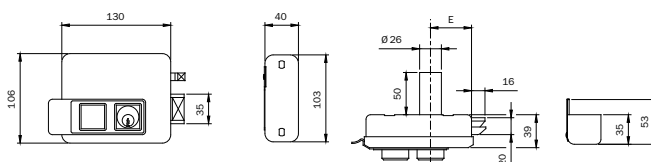

Key blank  
020259

OUTSIDE OPENING

**\* RIGHT-HAND** electric rim lock, painted, **FOR GATES FOR EXTERNAL OPENING. 12V-15W A.C.**

Internal pushbutton, internal cylinder for **PUSHBUTTON LOCKING** or **HOLD-OPEN** function, external fixed cylinder D 26 x 50. Self-locking latchbolt. Separate loading spring with adjustable force.

3 KEYS. Keep with nylon support and STAINLESS STEEL fixing plate. Escutcheon. Instruction sheet.

Fixing screws. (Key blank ref. N. 020259)

Backset mm 50	<b>510310505</b>	C	1	6	6
Backset mm 60	<b>510310605</b>	C	1	6	6
Backset mm 70	<b>510310705</b>	B	1	6	6
Backset mm 80	<b>510310805</b>	C	1	6	6

**\* LEFT-HAND** electric rim lock, painted, for **GATES FOR EXTERNAL OPENING. 12V-15W A.C.**

Internal pushbutton, internal cylinder for **PUSHBUTTON LOCKING** or **HOLD-OPEN** function, external fixed cylinder D 26 x 50. Self-locking latchbolt. Separate loading spring with adjustable force.

3 KEYS. Keep with nylon support and STAINLESS STEEL fixing plate. Escutcheon. Instruction sheet.

Fixing screws. (Key blank ref. N. 020259)

Backset mm 50	<b>510320505</b>	D	1	6	6
Backset mm 60	<b>510320605</b>	C	1	6	6
Backset mm 70	<b>510320705</b>	C	1	6	6
Backset mm 80	<b>510320805</b>	D	1	6	6

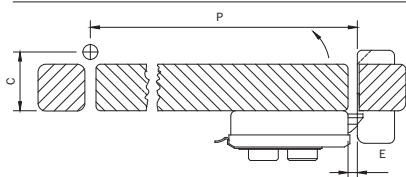

**\*INSTALLATION CONDITIONS FOR OUTSIDE OPENING**

- Dimension C: distance between the centres of the hinge and of the internal door edge max 80 mm
- Dimension P: door width min 900 mm
- Dimension E: distance between the lock and the keep max 9 mm



Code

Min. ord.  
Multiple  
package  
Single  
package  
Status

**Elettrica 500**

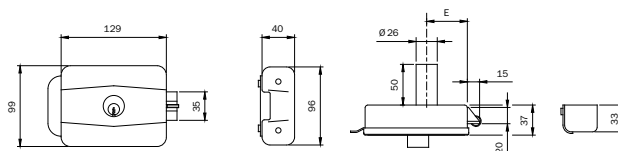

Key blank  
020259

**RIGHT- OR LEFT-HAND** electric rim lock, painted. **12V-15W A.C.** Internal cylinder and external fixed cylinder D 26 x 50. Self-locking latchbolt. Built-in loading spring with adjustable force. 3 KEYS. Adjustable keep. Escutcheon. Instruction sheet. (Key blank ref. N. 020259).

**Accessories to be ordered separately:**

Lock backplate and keep plate ref. N. 050010

Backset mm 50	<b>500500</b>	C	1	10	10
Backset mm 60	<b>500600</b>	A	1	10	10
Backset mm 70	<b>500700</b>	C	1	10	10
Backset mm 80	<b>500800</b>	D	1	10	10

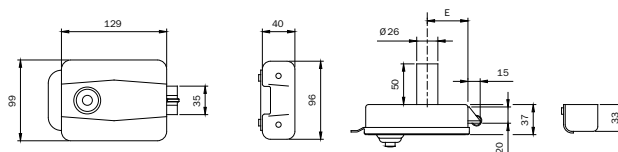

Key blank  
020259

**RIGHT- OR LEFT-HAND** electric rim lock, painted. **12V-15W A.C.** Internal pushbutton and external fixed cylinder D 26 x 50. Self-locking latchbolt. Built-in loading spring with adjustable force. 3 KEYS. Adjustable keep. Escutcheon. Instruction sheet. (Key blank ref. N. 020259).

Backset mm 50	<b>510500</b>	D	1	10	10
Backset mm 60	<b>510600</b>	A	1	10	10
Backset mm 70	<b>510700</b>	C	1	10	10
Backset mm 80	<b>510800</b>	C	1	10	10

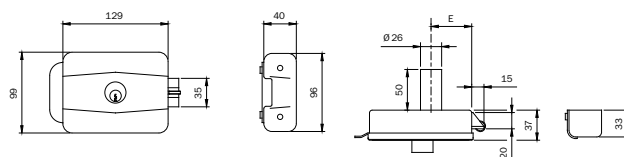

Key blank  
020259

**RIGHT- OR LEFT-HAND** electric rim lock, zinc-plated for iron frames. **12V-15W A.C.**

Internal pushbutton and external fixed cylinder D 26 x 50.

Self-locking latchbolt. Built-in loading spring with adjustable force. 3 KEYS. Adjustable keep.

Lock plate and keep plate. Escutcheon. Instruction sheet. (Key blank ref. N. 020259).

Backset mm 50	<b>505504</b>	C	1	10	10
Backset mm 60	<b>505604</b>	A	1	10	10
Backset mm 70	<b>505704</b>	B	1	10	10
Backset mm 80	<b>505804</b>	D	1	10	10



Code

Min. ord.  
Multiple  
package  
Single  
package  
Status

**Ferroglietto**



Key blank  
020259

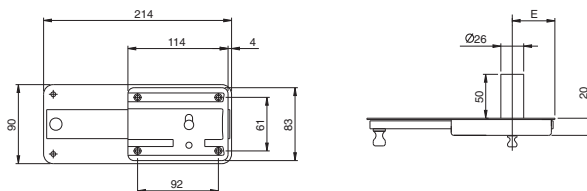

Rim lock for iron frames with knob to unlock the internal deadbolt and external fixed cylinder D mm 26 x 50,  
3 KEYS. **6-THROW DEADBOLT**. Packed in nylon bags. (Key blank ref. N. 020259)

Backset mm 50	<b>315506</b>	B	1	10	10
Backset mm 60	<b>315606</b>	A	1	10	10



Key blank  
020259

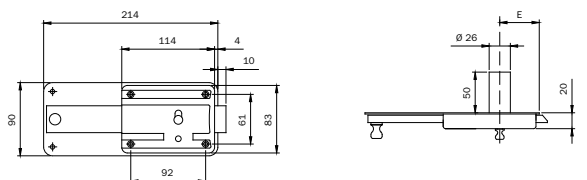

Rim lock for iron frames with knob to unlock the internal deadbolt and external fixed cylinder D mm 26 x 50,  
3 KEYS. **5-THROW DEADBOLT + BUILT-IN LATCHBOLT**. Packed in nylon bags.  
(Key blank ref. N. 020259)

Backset mm 50	<b>315505</b>	C	1	10	10
Backset mm 60	<b>315605</b>	B	1	10	10



Key blank  
020259

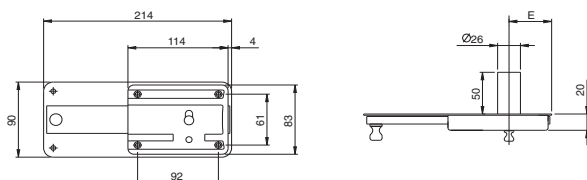

Rim lock for iron frames with knob to unlock the internal deadbolt and external fixed cylinder D mm 26 x 50,  
3 KEYS. **6-THROW DEADBOLT**. Keep. (Key blank ref. N. 020259)

Backset mm 50	<b>310604500</b>	B	1	10	10
Backset mm 60	<b>310604600</b>	B	1	10	10



Key blank  
020259

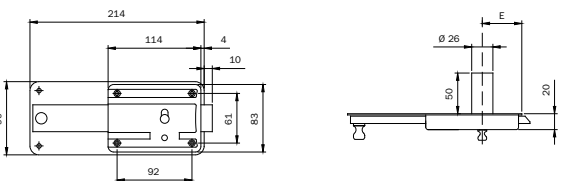

Rim lock for iron frames with knob to unlock the internal deadbolt and external fixed cylinder D mm 26 x 50,  
3 KEYS. **5-THROW DEADBOLT + BUILT-IN LATCHBOLT**.  
Keep (Key blank ref. N. 020259)

Backset mm 50	<b>310504500</b>	B	1	10	10
Backset mm 60	<b>310504600</b>	B	1	10	10



Code

Min. ord.  
Multiple  
package  
Single  
package  
Status

**Portoncino**



Key blank  
020259

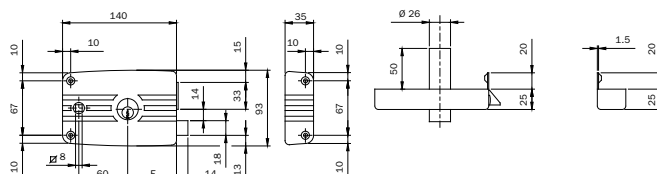

Rim lock for iron frames with blade, PAINTED BLACK, with internal cylinder and external fixed cylinder D mm 26 x 50, separate latchbolt, handle follower mm 8. 3-throw DEADBOLT. Backset mm 60. 3 KEYS. Keep. Escutcheon. (Key blank ref. N. 020259)

Backset mm 60 RIGHT	<b>481603</b>	A	2	10	10
Backset mm 60 LEFT	<b>482603</b>	A	2	10	10



Key blank  
020259

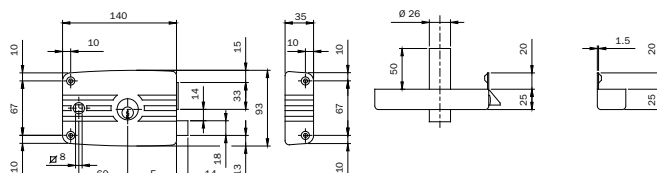

Rim lock for iron frames with blade, ZINC-PLATED, with internal cylinder and external fixed cylinder D mm 26 x 50, separate latchbolt, handle follower mm 8. 3-throw DEADBOLT. Backset mm 60. 3 KEYS. Keep. Escutcheon. (Key blank ref. N. 020259)

Backset mm 60 RIGHT	<b>481604</b>	B	2	10	10
Backset mm 60 LEFT	<b>482604</b>	C	2	10	10



Key blank  
020259

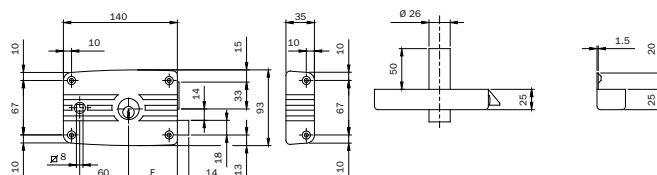

Rim lock for iron frames without blade, PAINTED BLACK, with internal cylinder and external fixed cylinder D mm 26 x 50, separate latchbolt, handle follower mm 8. 3-throw DEADBOLT. Backset mm 60. 3 KEYS. Keep. Escutcheon. (Key blank ref. N. 020259)

**Accessories to be ordered separately:**

Lock backplate and keep plate ref. N. 050011

Backset mm 60 RIGHT	<b>485603</b>	B	2	10	10
Backset mm 60 LEFT	<b>486603</b>	B	2	10	10



Code

Min. ord.  
Multiple  
package  
Single  
package  
Status

**Locks for iron frames**



Key blank  
020259

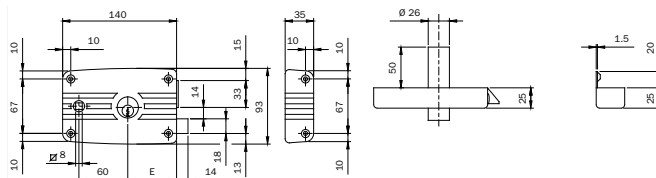

Rim lock for iron frames without blade, ZINC-PLATED, with internal cylinder and external fixed cylinder D mm 26 x 50, separate latchbolt, HANDLE FOLLOWER mm 8. 3-throw DEADBOLT. Backset mm 60. 3 keys. Keep. Escutcheon. (Key blank ref. N. 020259)

**Accessories to be ordered separately:**

Lock backplate and keep plate ref. N. 050011

Backset mm 60 RIGHT	<b>485604</b>	A	2	10	10
Backset mm 60 LEFT	<b>486604</b>	A	2	10	10



Key blank  
020259

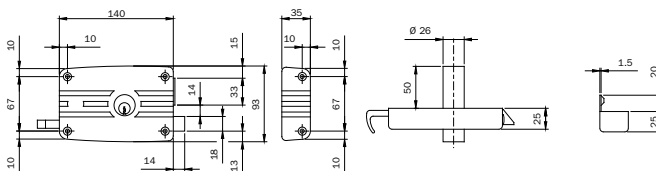

Rim lock for iron frames without blade, **RIGHT-HAND**. 4 fixing holes. Internal cylinder and external fixed cylinder D mm 26 x 50, separate reversible latchbolt with INTERNAL ROD and external latchlocking by key. 3-throw DEADBOLT. 3 KEYS. Keep. (Key blank ref. N. 020259)

**Accessories to be ordered separately:**

Lock backplate and keep plate ref. N. 050011

Backset mm 60 RIGHT	<b>431604...4</b>	A	2	10	10
Backset mm 70 RIGHT	<b>431704...4</b>	B	2	10	10

Rim lock for iron frames without blade, **LEFT-HAND**. 4 fixing holes. Internal cylinder and external fixed cylinder D mm 26 x 50, separate reversible latchbolt with INTERNAL ROD and external latchlocking by key. 3-throw DEADBOLT. 3 KEYS. Keep. (Key blank ref. N. 020259)

**Accessories to be ordered separately:**

Lock backplate and keep plate ref. N. 050011

Backset mm 60 LEFT	<b>432604...4</b>	B	2	10	10
Backset mm 70 LEFT	<b>432704...4</b>	B	2	10	10





Code

Min. ord.  
Multiple  
package  
Single  
package  
Status

**Locks for iron frames  
zinc-plated front plate mm 25**

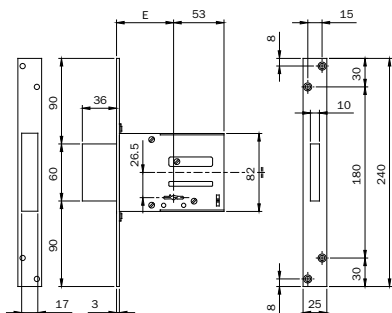

Locks for iron frames and gates. LATERAL LOCKING. Double-bit key. Zinc-plated case. Zinc-plated front plate mm **240 x 25 x 3**. Rectangular DEADBOLT with 4 throws mm 9.

2 KEYS. (Key blank ref. N. 990802) 2 zinc-plated key guides. **PACKED IN NYLON BAGS.**

**Accessories to be ordered separately:**

Zinc-plated striking plate - ref. N. 990817

Backset mm 52	<b>661524N</b>	B	1	10	10
Backset mm 60	<b>661604N</b>	A	1	10	10
Backset mm 70	<b>661704N</b>	A	1	10	10

Locks for iron frames and gates. LATERAL LOCKING. Double-bit key. Keyed-alike version (K.A.)

in groups of 10 pieces. Zinc-plated case. Zinc-plated front plate mm **240 x 25 x 3**. Rectangular DEADBOLT with 4 throws mm 9. 1 key. (Key blank ref. N. 990802).

2 zinc-plated key guides. **PACKED IN NYLON BAGS.**

**Accessories to be ordered separately:**

Zinc-plated striking plate - ref. N. 990817

Backset mm 52	<b>661524N.K</b>	C	1	10	10
Backset mm 60	<b>661604N.K</b>	B	1	10	10
Backset mm 70	<b>661704N.K</b>	B	1	10	10

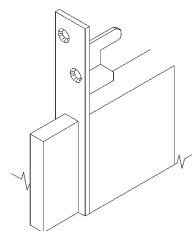
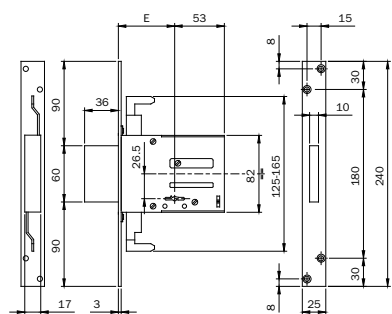

Locks for iron frames and gates. 3-POINT LOCKING for rod clutch connection. Double-bit key.

Zinc-plated case. Zinc-plated front plate mm **240 x 25 x 3**. Rectangular deadbolt with 4 throws mm 9.

2 KEYS. (Key blank ref. N. 990802). 2 zinc-plated key guides. **PACKED IN NYLON BAGS.**

**Accessories to be ordered separately:**

Screwed connection M8 for threaded rods - ref. N. 990823

pins, tips and rod guides for rods D8 - ref. N. 990837

Pair of deviated slotted internal rods D8 - ref. N. 990810

Pair of straight slotted internal rods D8 - ref. N. 990811

Zinc-plated striking plate - ref. N. 990817

Backset mm 60	<b>663604N</b>	B	1	10	10
Backset mm 70	<b>663704N</b>	B	1	10	10

**Locks for iron frames zinc-plated front plate mm 25**



Code

Min. ord.  
Multiple package  
Single package  
Status

Locks for iron frames and gates. 3-POINT LOCKING for rod clutch connection. Double-bit key.  
**KEYED-ALIKE VERSION (K.A.)** in groups of 10 pieces. Zinc-plated case. Zinc-plated front plate mm 240 x 25 x 3.  
Rectangular DEADBOLT with 4 throws mm 9.  
1 KEY. (Key blank ref. N. 990802). 2 zinc-plated key guides. **PACKED IN NYLON BAGS.**

**Accessories to be ordered separately:**

- Screwed connection M8 for threaded rods - ref. N. 990823
- pins, tips and rod guides for rods D8 - ref. N. 990837
- Pair of deviated slotted internal rods D8 - ref. N. 990810
- Pair of straight slotted internal rods D8 - ref. N. 990811
- Zinc-plated striking plate - ref. N. 990817

Backset mm 60	<b>663604N.K</b>	B	1	10	10
Backset mm 70	<b>663704N.K</b>	B	1	10	10

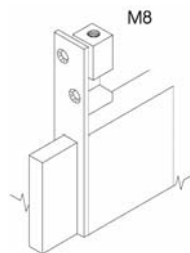
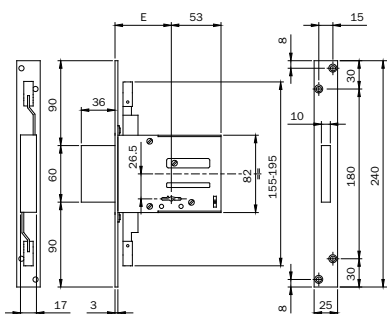

Locks for iron frames and gates. 3-POINT LOCKING, pre-assembled M8 rods connection. Double-bit key. Zinc-plated case. Zinc-plated front plate mm **240 x 25 x 3**.  
Rectangular DEADBOLT with 4 throws mm 9. .  
2 KEYS. (Key blank ref. N. 990802). 2 zinc-plated key guides. **PACKED IN NYLON BAGS.**

**Accessories to be ordered separately:**

- 2 tips D10 for threaded rods M8 - ref. N. 990836
- pins, tips and rod guides for rods D8 - ref. N. 990837
- Zinc-plated striking plate - ref. N. 990817

Backset mm 60	<b>663301604</b>	A	1	10	10
Backset mm 70	<b>663301704</b>	A	1	10	10

Locks for iron frames and gates. 3-POINT LOCKING. Double-bit key.  
**KEYED-ALIKE VERSION (K.A.)** in groups of 10 pieces. Zinc-plated case.  
Zinc-plated front plate mm **240 x 25 x 3**. Rectangular DEADBOLT with 4 throws mm 9..  
KEY. (Key blank ref. N. 990802). 2 zinc-plated key guides. **PACKED IN NYLON BAGS.**

1

**Accessories to be ordered separately:**

- 2 tips D10 for threaded rods M8 - ref. N. 990836
- pins, tips and rod guides for rods D8 - ref. N. 990837
- Zinc-plated striking plate - ref. N. 990817

Backset mm 60	<b>663301604.K</b>	B	1	10	10
Backset mm 70	<b>663301704.K</b>	B	1	10	10



Code

Min. ord.  
Multiple  
package  
Single  
package  
Status

**Gate locks**

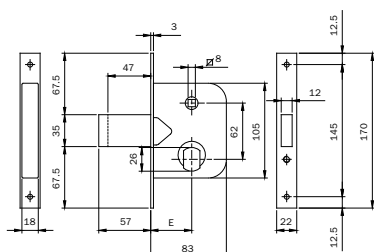

Gate lock. Tropicalised, zinc-plated case and front plate. Operating with multi-faceted cylinder D mm 26.  
EXTENDED DEADBOLT AND BUILT-IN LATCHBOLT. **1 THROW 10 mm**. Latchlocking by key or handle follower  
mm 8. Backset mm 45. Supplied with cylinder 842028287 and 3 KEYS. 2 nylon escutcheons for cylinder.  
(Key blank ref. N. 020259)

**600450** A 2 10 10

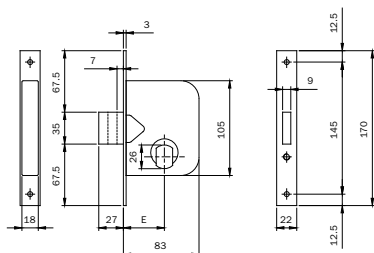

Gate lock. Tropicalised, zinc-plated case and front plate. Operating with multi-faceted cylinder D mm 26.  
**2 THROWS 10 mm**. Backset mm 45. Supplied with cylinder 842028287 and 3 KEYS.  
2 nylon escutcheons for cylinder. (Key blank ref. N. 020259)

**601450** A 2 10 10

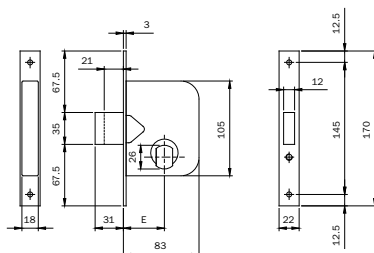

Gate lock. Tropicalised, zinc-plated case and front plate. Operating with multi-faceted cylinder D mm 26.  
**1 THROW 10 mm AND BUILT-IN LATCHBOLT**. Backset mm 45. Supplied with cylinder 842028287 and 3 KEYS.  
2 nylon escutcheons for cylinder. (Key blank ref. N. 020259)

**603450** B 2 10 10

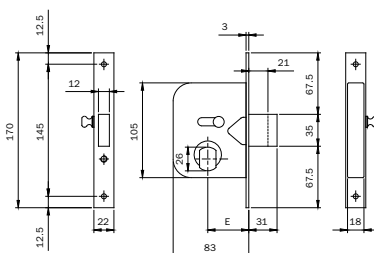

Gate lock. Tropicalised, zinc-plated case and front plate. Operating with multi-faceted cylinder D mm 26.  
Built-in latchbolt and deadbolt. **1 THROW 10 mm**. Latchlocking by key or internal knob  
Backset mm 45. Supplied with cylinder 842028287 and 3 KEYS. 2 nylon escutcheons for cylinder.  
(Key blank ref. N. 020259)

**604450** A 2 10 10



Code

Min. ord.  
Multiple  
package  
Single  
package  
Status

**Gate locks**

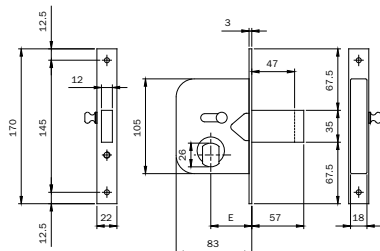
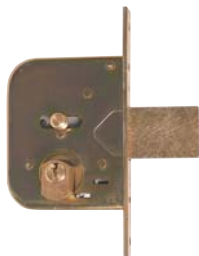

Gate lock. Tropicalised, zinc-plated case and front plate. Operating with multi-faceted cylinder D mm 26.  
EXTENDED DEADBOLT AND BUILT-IN LATCHBOLT. **1 THROW 10 mm**. Latchlocking by key or internal knob.  
Backset mm 45. Supplied with cylinder 842028287 and 3 KEYS. 2 nylon escutcheons for cylinder.  
(Key blank ref. N. 020259)

**604451** B 2 10 10

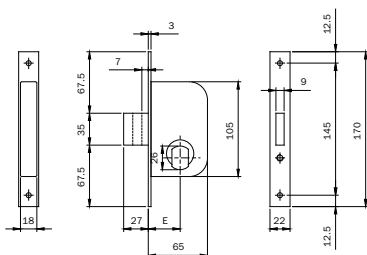

Gate lock. Tropicalised, zinc-plated case and front plate. Operating with multi-faceted cylinder D mm 26.  
**1 THROW 10 mm AND BUILT-IN LATCHBOLT**. Backset mm 45. Supplied with cylinder 842028287 and 3 KEYS.  
2 nylon escutcheons for cylinder. (Key blank ref. N. 020259)

**605350** B 2 10 10

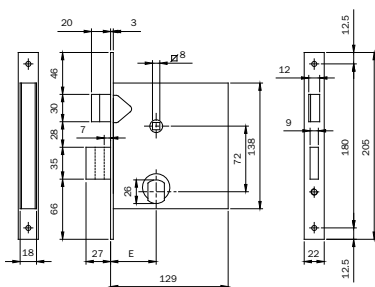

Gate lock. Tropicalised, zinc-plated square case and front plate. Operating with multi-faceted cylinder D mm 26.  
SEPARATE LATCHBOLT AND DEADBOLT. **2 THROWS 10 mm**. Latchlocking by key or handle follower mm 8.  
Backset mm 50. Supplied with cylinder 842028287 and 3 KEYS. 2 nylon escutcheons for cylinder.  
(Key blank ref. N. 020259)

**610500** C 2 10 10



Code

Status  
Single  
package

Multiple  
package

Min. ord.

**Gate locks**

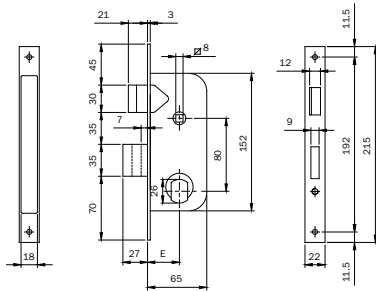

Gate lock. Tropicalised, zinc-plated case and front plate. Operating with multi-faceted cylinder D mm 26.  
SEPARATE LATCHBOLT AND DEADBOLT. **2 THROWS 10 mm**. Latchlocking by key or handle follower mm 8.  
Backset mm 35. Supplied with cylinder 842028287 and 3 KEYS. 2 nylon escutcheons for cylinder.  
(Key blank ref. N. 020259)

**620350**

A 2 10 10

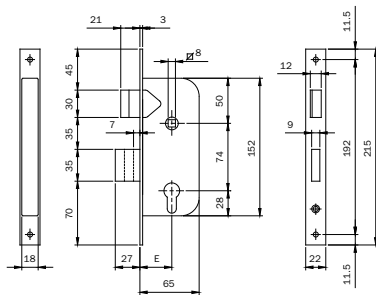

Gate lock. Tropicalised, zinc-plated case and front plate. Operating with European-profile cylinder  
SEPARATE LATCHBOLT AND DEADBOLT. **2 THROWS 10 mm**. Latchlocking by key or handle follower mm 8.  
Backset mm 35. Cylinder to be ordered separately.

**630350**

A 2 10 10



Code

Min. ord.  
Multiple  
package  
Single  
package  
Status

**Locks for shutters and garage doors**

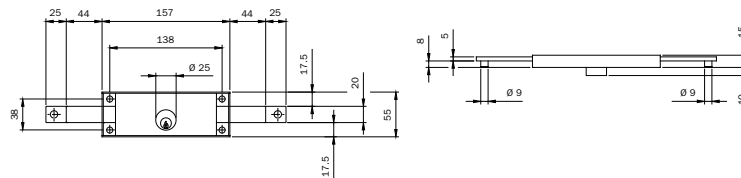

Shutter lock. Horizontal **CENTRAL** installation. Painted case. Zinc-plated deadbolts, one throw mm 25.  
ROD-CONNECTING PINS D mm 9 x 8. Round cylinder D mm 25 protruding by 10 mm from the lock case,  
2 CENTRAL-PROFILE KEYS (Key blank ref. N. 020409).

**Accessories to be ordered separately:**

U-bolts without blades - ref. N. 010004

U-bolt with blades - ref. N. 010005

**641010** A 1 10 10

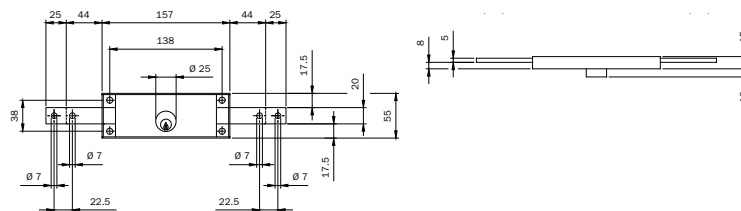

Shutter lock. Horizontal **CENTRAL** installation. Painted case. Zinc-plated deadbolts, each with  
2 THREADED HOLES D 7 FOR RODS CONNECTION, one throw mm 25.  
Round cylinder D mm 25 protruding by 10 mm from the lock case,  
2 CENTRAL-PROFILE KEYS (Key blank ref. N. 020409). 2 pins.

**Accessories to be ordered separately:**

U-bolts without blades - ref. N. 010004

U-bolt with blades - ref. N. 010005

**641014** C 1 10 10

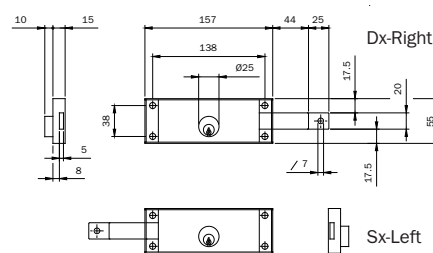

Shutter lock. **RIGHT-HAND**, horizontal lateral installation. Painted case. Zinc-plated deadbolt with D7 HOLE  
FOR RODS CONNECTION, one throw mm 25. Round cylinder D mm 25 protruding by 10 mm from the lock case.  
2 CENTRAL-PROFILE KEYS (Key blank ref. N. 020409).

**Accessories to be ordered separately:**

U-bolts without blades - ref. N. 010004

U-bolt with blades - ref. N. 010005

**642001** A 2 10 10



Code

Min. ord.  
Multiple  
package  
Single  
package  
Status

**Locks for shutters and garage doors**

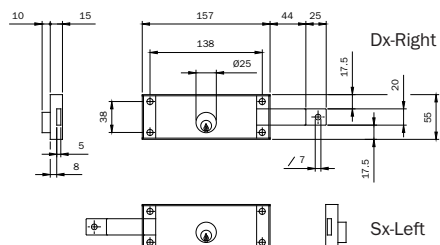

Shutter lock. **LEFT-HAND**, horizontal lateral installation. Painted case. Zinc-plated DEADBOLT with D7 HOLE FOR RODS CONNECTION, one throw mm 25. Round cylinder D mm 25 protruding by 10 mm from the lock case.

2 CENTRAL-PROFILE KEYS (Key blank ref. N. 020409).

**Accessories to be ordered separately:**

U-bolts without blades - ref. N. 010004

U-bolt with blades - ref. N. 010005

**642002** A 2 10 10

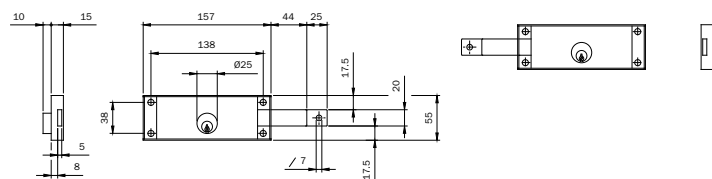

Pair of keyed-alike shutter locks. **RIGHT- AND LEFT-HAND**, horizontal lateral installation. Painted case. Zinc-plated DEADBOLT with HOLE D 7 FOR RODS CONNECTION, one throw mm 25.

Round cylinder D mm 25 protruding by 10 mm from the lock case.

2 CENTRAL-PROFILE KEYS (Key blank ref. N. 020409).

**Accessories to be ordered separately:**

U-bolts without blades - ref. N. 010004

U-bolt with blades - ref. N. 010005

**642003** A 1 5 5

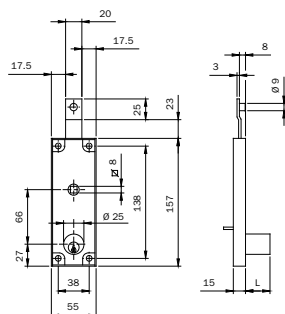

Shutter gate. **VERTICAL** installation. Painted case. Zinc-plated DEADBOLT with PIN D MM 9 X 8 FOR ROD CONNECTION. 1 throw mm 25 with handle, handle follower mm 8, handle unlocked by round cylinder D mm 25 from outside and by lever from inside. Cylinder protruding from lock case.

2 STANDARD-PROFILE KEYS (Key blank ref. N. 020259).

**Accessories to be ordered separately:**

U-bolts without blades - ref. N. 010004

U-bolts with blades - ref. N. 010005

cylinder projection mm14

**643150** A 2 10 10

cylinder projection mm30

**643300** C 2 10 10



Code

Min. ord.  
Multiple  
package  
Single  
package  
Status

**Locks for shutters and garage doors**

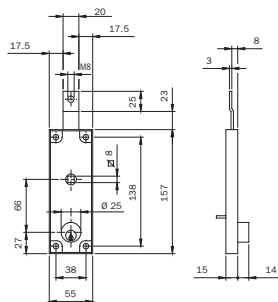

Shutter gate. **VERTICAL** installation. Painted case. Zinc-plated DEADBOLT with M8 THREADED HOLE FOR ROD CONNECTION. 1 throw mm 25 with handle, handle follower mm 8, handle unlocked by round cylinder D mm 25 from outside and by lever from inside. Cylinder protruding from lock case by 14 mm  
2 STANDARD-PROFILE KEYS (Key blank ref. N. 020259).

**Accessories to be ordered separately:**

U-bolts without blades - ref. N. 010004

U-bolt with blades - ref. N. 010005

**644150** B 2 10 10

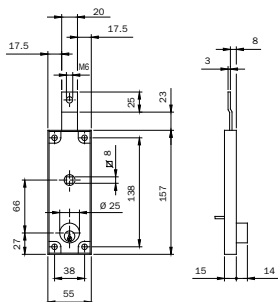

Shutter gate. **VERTICAL** installation. Painted case. Zinc-plated DEADBOLT with M6 THREADED HOLE FOR ROD CONNECTION. 1 throw mm 25 with handle, handle follower mm 8, handle unlocked by round cylinder D mm 25 from outside and by lever from inside. Cylinder protruding from lock case by 14 mm  
2 STANDARD-PROFILE KEYS (Key blank ref. N. 020259). **PACKED IN NYLON BAGS.**

**Accessories to be ordered separately:**

U-bolts without blades - ref. N. 010004

U-bolt with blades - ref. N. 010005

**645150W** C 1 10 10

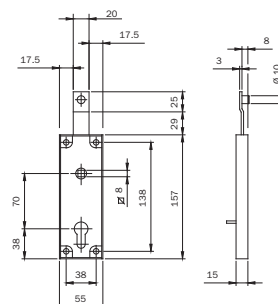

Shutter gate. **VERTICAL** installation. Painted case. Operating with European-profile cylinder. Zinc-plated DEADBOLT with PIN D MM 10 X 8 FOR ROD CONNECTION. 1 throw mm 25 with handle, handle follower mm 8, handle unlocked by cylinder from outside and by lever from inside. Cylinder fixing screw.

**Accessories to be ordered separately:**

U-bolts without blades - ref. N. 010004

U-bolt with blades - ref. N. 010005

**646000** B 2 10 10







Code

Min. ord.  
Multiple  
package  
Single  
package  
Status

**Locks for shutters and garage doors**

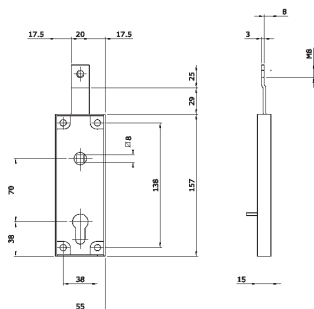

Shutter gate. **VERTICAL** installation. Painted case. Operating with European-profile cylinder.

Zinc-plated DEADBOLT with M8 THREADED HOLE FOR ROD CONNECTION. 1 throw mm 25 with handle, handle follower mm 8, handle unlocked by cylinder from outside and by lever from inside. Cylinder fixing screw.

**Accessories to be ordered separately:**

U-bolts without blades - ref. N. 010004

U-bolt with blades - ref. N. 010005

**647000** C 2 10 10

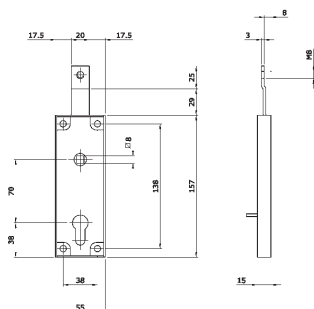

Lock for overhead garage door. **VERTICAL** locking with profile cylinder to be ordered separately.

DEADBOLT with M8 THREADED HOLE FOR ROD CONNECTION,

**WITHOUT INTERNAL OPENING LEVER, PACKED IN NYLON BAGS.**

**Accessories to be ordered separately:**

U-bolts without blades - ref. N. 010004

U-bolt with blades - ref. N. 010005

**647005WVR** D 1 50 50



Code

Status  
Single  
package  
Multiple  
package  
Min. ord.

**Chiuditutto rim locks**

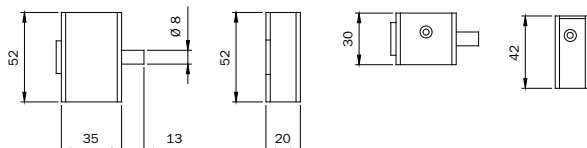

MULTIUSO rim lock, for indoor use. Locking by pushbutton and cylinder. DEADBOLT with D8 pin throw mm 13. Adjustable keep. 2 KEYS. Screws. (Key blank 020149)



GOLD painted	<b>950001</b>	D	1	5	5
GOLD painted coding 550	<b>950001..21</b>	D	1	-	1
GOLD painted coding 560	<b>950001..22</b>	D	1	-	1
GOLD painted coding 570	<b>950001..23</b>	D	1	-	1
GOLD painted coding 580	<b>950001..24</b>	D	1	-	1
GOLD painted coding 590	<b>950001..25</b>	D	1	-	1



BRONZE painted	<b>950002</b>	D	1	5	5
BRONZE painted coding 550	<b>950002..21</b>	D	1	-	1
BRONZE painted coding 560	<b>950002..22</b>	D	1	-	1
BRONZE painted coding 570	<b>950002..23</b>	D	1	-	1
BRONZE painted coding 580	<b>950002..24</b>	D	1	-	1
BRONZE painted coding 590	<b>950002..25</b>	D	1	-	1



GREY painted	<b>950003</b>	D	1	5	5
GREY painted coding 550	<b>950003..21</b>	D	1	-	1
GREY painted coding 560	<b>950003..22</b>	D	1	-	1
GREY painted coding 570	<b>950003..23</b>	D	1	-	1
GREY painted coding 580	<b>950003..24</b>	D	1	-	1
GREY painted coding 590	<b>950003..25</b>	D	1	-	1



WHITE painted	<b>950004</b>	D	1	5	5
WHITE painted coding 550	<b>950004..21</b>	C	1	-	1
WHITE painted coding 560	<b>950004..22</b>	D	1	-	1
WHITE painted coding 570	<b>950004..23</b>	D	1	-	1
WHITE painted coding 580	<b>950004..24</b>	D	1	-	1
WHITE painted coding 590	<b>950004..25</b>	D	1	-	1



BLACK painted	<b>950005</b>	B	1	5	5
BLACK painted coding 550	<b>950005..21</b>	C	1	-	1
BLACK painted coding 560	<b>950005..22</b>	C	1	-	1
BLACK painted coding 570	<b>950005..23</b>	D	1	-	1
BLACK painted coding 580	<b>950005..24</b>	C	1	-	1
BLACK painted coding 590	<b>950005..25</b>	D	1	-	1

Code  
Status  
Single  
package  
Multiple  
package  
Min. ord.

**Accessories**



Multi-faceted tip D 14 for threaded rods M8. For **MULTIBLINDO**.  
In carbonitrided zinc-plated steel.  
Elastic pin. Drawing pin.

**040808** D 10 - 10



Deadbolt with gorges, assembled, for locks for metal frames series 981-983.  
Three mm 79 keys.

**980000** D 10 - 10



Roller for double-bit modular lock. With nylon insert for adjustable striking plates.  
Spring. Spring plate.

**040820** B 10 - 10



Cap for double-bit modular locks. In nickel-plated zamak. To be fitted instead of the latchbolt  
for only deadbolt version. Screw.

**040830** B 10 - 10

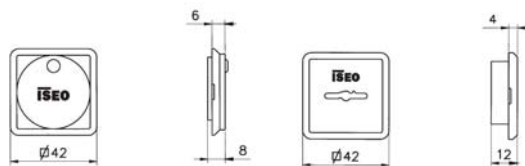

Pair of nylon key-guides for locks series 961-963-981-983.

**990808** D 30 - 30

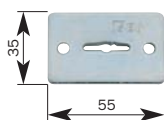

Pair of key-guiding escutcheons for double-bit locks. In zinc-plated steel mm 55x35. For locks  
series 661-663-961-963-981-983

**990846** B 10 - 10

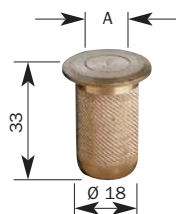

Brass floor socket with antidust spring cap for rods. Inside hole D 14.

**990804** D 10 - 10

Brass floor socket with antidust spring cap for rods. Inside hole D 12.

**990807** B 10 - 10

Code  
Status  
Single  
package  
Multiple  
package  
Min. ord.

**Accessories**

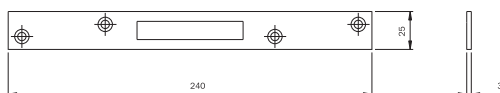

Zinc-plated striking plate 240x25x3 for locks series 661-663-6663.

**990817** B 20 - 20

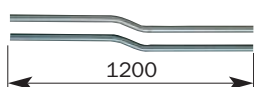

Pair of internal deviated rods. Zinc-plated tube D 8. For locks with clutch connections series 782-783-963-983

**990810** C 1 10 10

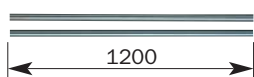

Pair of internal straight rods. Zinc-plated tube D 8. For locks with clutch connections series 782-783-963-983

**990811** A 1 10 10



D10 rod/tip-guiding upper plate in zinc-plated steel. Nylon bush.

**990816** D 10 - 10



Kit for internal deviated or straight D 8 with rods clutch connection. Two tips D8. One rod connection. Two zamak rod guides. Two nylon rod guides. Two lock-fixing plates. One antidust floor socket hole D 12. For locks series 782-783-793-963-983.

**990827** C 10 - 10



Kit for external rods for frames with clutch connection. Two external rod-connecting plates. Screws. Two lock-fixing plates. One antidust floor socket hole D 12. For locks series 782-783-793 Front plate with 2 holes.

**990828** D 10 - 10



Kit for external rods for frames with clutch connection. Two external rod-connecting plates. Screws. Two lock-fixing plates. One antidust floor socket hole D 12. For locks series 963-983. Front plate with 4 holes.

**990829** D 10 - 10



Threaded connection M8 for threaded rod. For use with 3-point locks for metal frames series 663-782-783-963-983. Utilizzabile con aggancio aste ad innesto o a vite.

**990823** A 20 - 20



Rectangular plate 28x17,8 in zinc-plated steel for lock fixing. Screws.

**990834** D 10 - 10



Rhomboidal plate 19x14 in STAINLESS STEEL for lock fixing. Screws.

**990835** D 10 - 10



Pair of D 10 tips in zinc-plated steel for M8 threaded rods.

**990836** B 10 - 10

Code  
Status  
Single  
package  
Multiple  
package  
Min. ord.

**Accessories**



Kit for internal straight rods D 8 for use with M8 threaded connection. Two carbonitrided tips D10.  
Two threaded pins for fixing to connection. Two rod-guiding plates with nylon bushes.

**990837** B 10 - 10

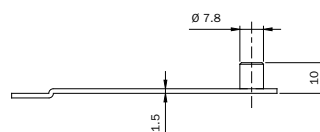
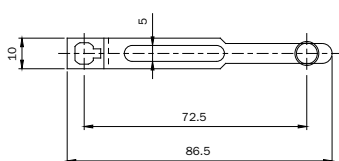

Pair of plates with pin to connect the lock or the deviators with screw connections M4 and external rods.  
In zinc-plated steel.

**990853** A 10 - 10



Kit for internal straight or deviated rods D 8. Two tips D8. One rod connection. Two zamak rod guides.  
Two lock-fixing plates. Screws.

**990857** C 10 - 10

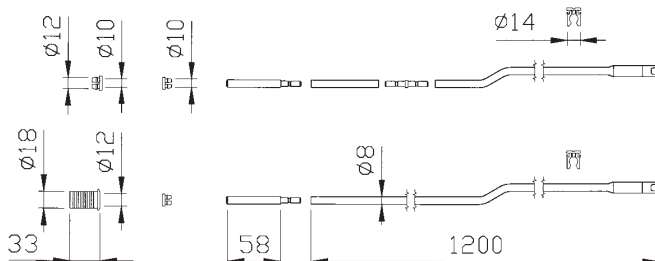

Pair of internal deviated rods. Zinc-plate tube D 8 with slotted hole for screwed connection M4. Two tips D8.  
Striker for nylon tip D8. Two noiseproof nylon bushes. One rod connection. Two nylon rod guides. Two lock-fixing plates.  
One antidust floor socket hole D12. For locks with rods screwed connection series 7820-783\*-963\*

**990850** C 1 5 5

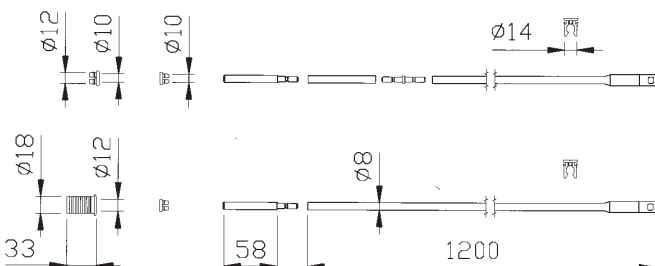

Pair of internal straight rods. Zinc-plate tube D 8 with slotted hole for screwed connection M4. Two tips D8.  
Striker for nylon tip D8. Two noiseproof nylon bushes. One rod connection. Two nylon rod guides.  
One antidust floor socket hole D12. For locks with rods screwed connection series 7820-783\*-963\*

**990851** A 1 5 5

Code  
Status  
Single  
package  
Multiple  
package  
Min. ord.

**Accessories**



Pair of front plate supports in NYLON 22x8 for locks operating with European-profile cylinder for double-bit aluminium locks.

**038019** B 10 - 10

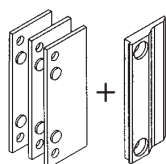

Latchbolt-guiding slide for aluminium frames for external opening. Three spacers. In nylon.

**990842** D 10 - 10

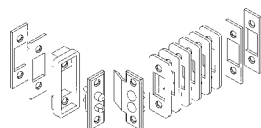

Pair of pressure electric contacts for electric locks 12V. Six spacers mm 2x22. Four spacers mm 2x16. One spacer mm 5. Instructions.

**050060** A 10 - 10



Pair of standard coils **12V-15W A.C.** for electric rim locks series 500-505-510

**050020** B 10 - 10



Pair of standard coils for double-bit electric locks for metal frames **12V-15W A.C.** series 78\*\*-96\*\*-.

**050024** D 10 - 10



Pair of standard coils **12V-15W A.C.** for oval-cylinder electric locks for metal frames series 550-551

**050030** D 10 - 10



Pair of standard coils **12V-15W A.C.** for electric rim locks series 52\*\*-53\*\*-.

**050035** A 10 - 10

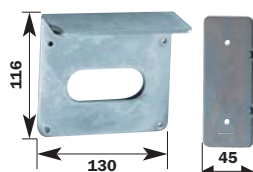

Support for right/left-hand electric locks series 500-505-510. Lock backplate and keep plate in zinc-plated steel. Screws.

**050010** C 5 - 5

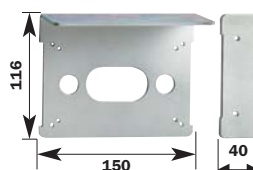

Support for right/left-hand locks with handle follower series 481-482-485-486 and with internal zinc-plated rod 431-432. Lock backplate and keep plate in zinc-plated steel. Screws.

**050011** B 5 - 5

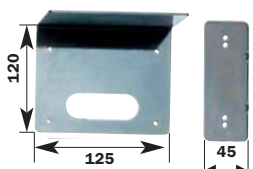

Support for right/left-hand electric locks series 52\*\*-53\*\*-.

**050012** B 6 - 6

Code  
Status  
Single  
package  
Multiple  
package  
Min. ord.

**Accessories**

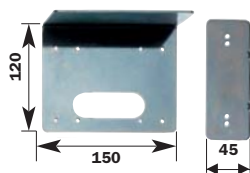

Support for right/left-hand electric locks in stainless steel 52\*\*-53\*\*. Lock backplate and keep plate in STAINLESS STEEL. Screws.

**052012** B 6 - 6

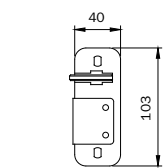

Keep in STAINLESS STEEL for electric locks series 52\*\*. STAINLESS STEEL sliding plate.

**RIGHT** **050108** D 5 - 5

**LEFT** **050109** D 5 - 5

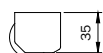
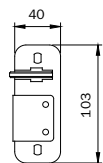
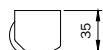

Keep in grey painted steel for electric locks series 520\*-522\*-523\*-525\*. STAINLESS STEEL sliding plate.

**RIGHT** **050112** D 5 - 5

**LEFT** **050113** D 5 - 5

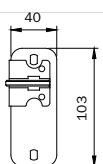

Keep in STAINLESS STEEL for electric locks series 53\*\*. STAINLESS STEEL sliding plate.

**RIGHT** **050128** D 5 - 5

**LEFT** **050129** D 5 - 5

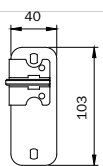

Keep in grey painted steel for electric locks series 530\*-532\*-535\*. STAINLESS STEEL sliding plate.

**RIGHT** **050132** D 5 - 5

**LEFT** **050133** D 5 - 5

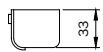
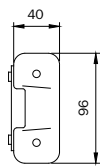

Keep for electric locks series 505. In zinc-plated steel. STAINLESS STEEL sliding plate

**RIGHT/LEFT** **050004** D 10 - 10

Keep for electric locks series 500-501-510-511. In grey painted steel. STAINLESS STEEL sliding plate

**RIGHT/LEFT** **050005** D 10 - 10

Code  
Status  
Single  
package  
Multiple  
package  
Min. ord.

**Accessories**

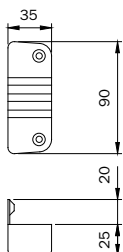

Painted steel keep. Standard version for PORTONCINO

**RIGHT-HAND** series 401-411-421-431-437-451

**035035** D 10 - 10

**LEFT-HAND** series 402-412-422-432-438-452

**035036** D 10 - 10

ZINC-PLATED steel keep. Standard version for PORTONCINO

**RIGHT-HAND** series 431-481-485

**035135** D 10 - 10

**LEFT-HAND** series 432-482-486

**035136** D 10 - 10

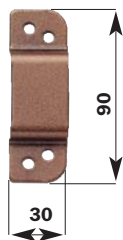

Painted steel U-keep. Standard version for series 3105-3106

**035005** D 10 - 10



U-bolt for shutter without blades for series 641-642-643-646-647

**010004** D 10 - 10

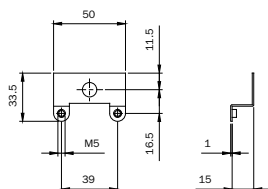

U-bolt for shutter with blades for series 641-642-643-646-647

**010005** D 10 - 10

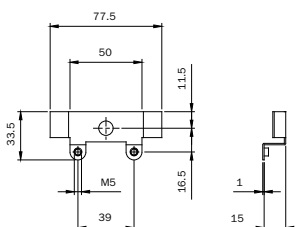



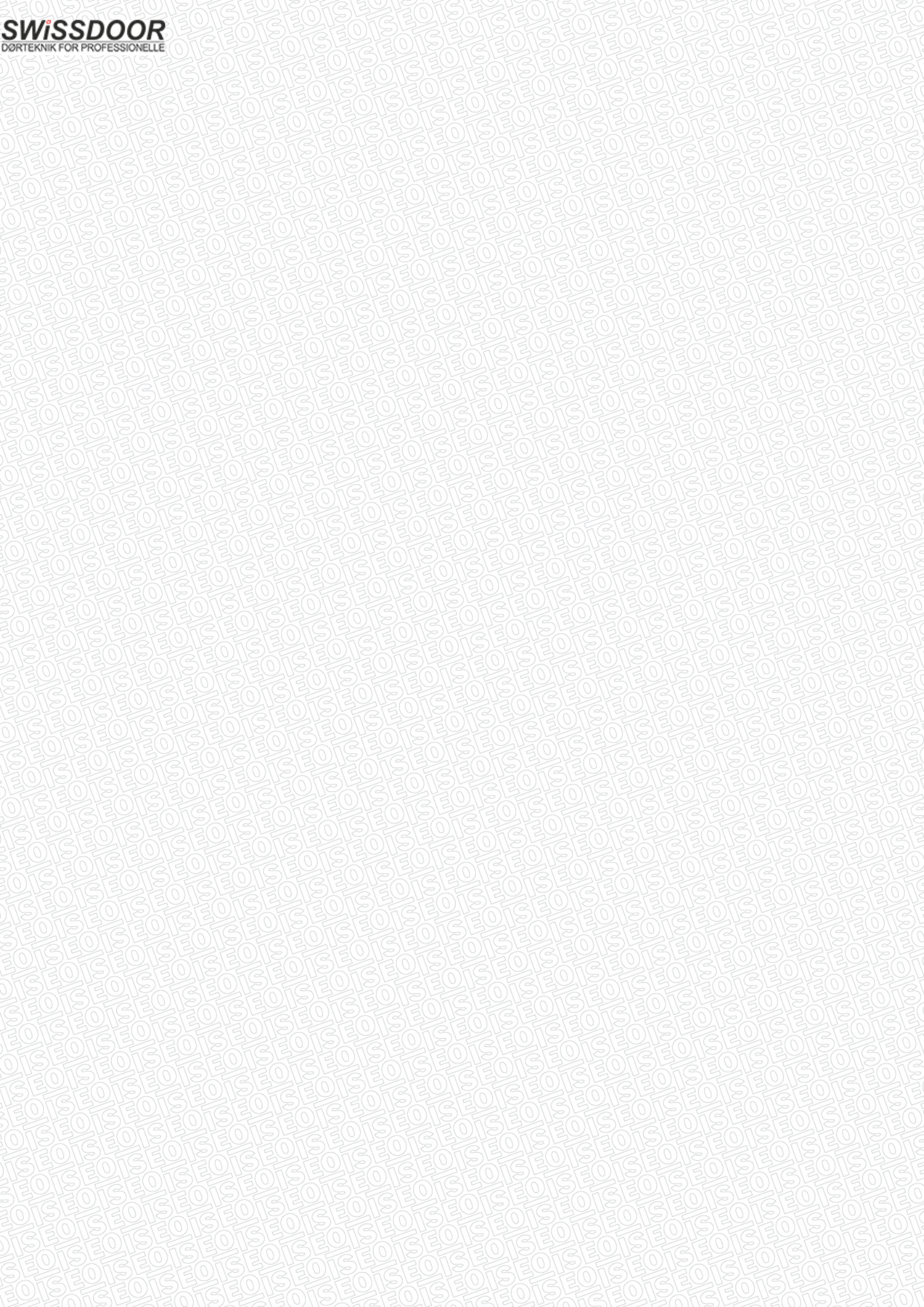



## **Match**

**Electric  
strickers**



Code

Min. ord.  
Multiple  
package  
Single  
package  
Status

**Match Radiale**

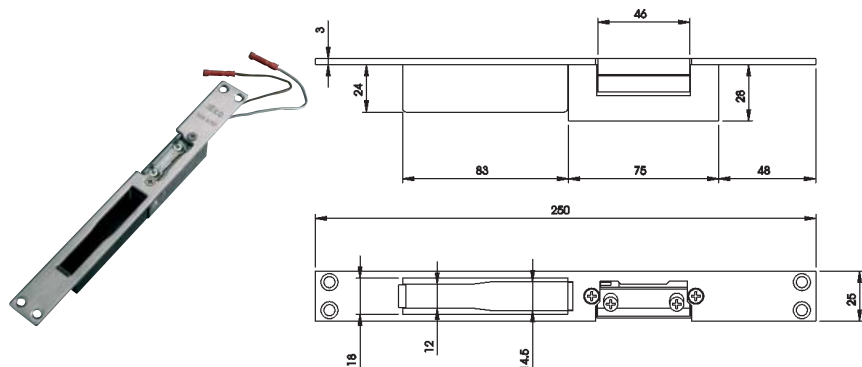

\* D.C.: max. power supply time  
10 seconds

Electric striker with closed **REVERSIBLE** striking plate, satin STAINLESS STEEL, flat front plate mm 250X25X3, for locks 78\*96\*7-96\*9-98. Can be used with electric strikers series 0400\*0 and 0401\*0. **AUTOMATIC-UNLATCHING VERSION AFTER ELECTRIC PULSE**, with hold-open lever. Voltage: **6-12V. A.C./D.C.\*** Absorption: da 0,5 a 1,5 A. with nylon case

**5661900** A 1 6 1

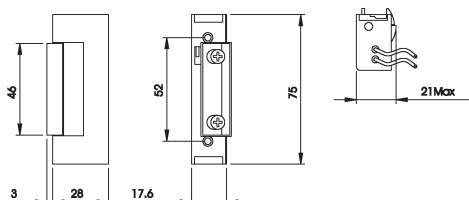

\* D.C.: max. power supply time  
10 seconds

Electric striker without front plate, **UNLATCHED AFTER ELECTRIC PULSE ONLY**, with hold-open lever. Voltage: **6-12V. A.C./D.C.\*** Absorption: 0,5 to 1,5 A. REVERSIBLE.

**040010** B 1 6 6

Voltage: **24V. A.C./D.C.\*** Absorption: 0,5 A. REVERSIBLE

**040050** D 1 6 6

Electric striker without front plate, **UNLATCHED AFTER ELECTRIC PULSE ONLY**, without hold-open lever. Voltage: **6-12V. A.C./D.C.\*** Absorption: 0,5 to 1,5 A. REVERSIBLE

**040020** C 1 6 6

Voltage: **24V. A.C./D.C.\*** Absorption: 0,5 A. REVERSIBLE

**040060** C 1 6 6

Electric striker without front plate, **PERMANENT UNLATCHING AFTER ELECTRIC PULSE** with hold-open lever. Voltage: **6-12V. A.C./D.C.\*** Absorption: 0,5 to 1,5 A. REVERSIBLE

**040030** A 1 6 6

Voltage: **24V. A.C./D.C.\*** Absorption: 0,5 A. REVERSIBLE

**040070** D 1 6 6

Electric striker without front plate, **PERMANENT UNLATCHING AFTER ELECTRIC PULSE**, without hold-open lever.

Voltage: **6-12V. A.C./D.C.\*** Absorption: 0,5 to 1,5 A. REVERSIBLE

**040040** C 1 6 6

Voltage: **24V. A.C./D.C.\*** Absorption: 0,5 A. REVERSIBLE

**040080** D 1 6 6



Code

Min. ord.  
Multiple  
package  
Single  
package  
Status

**Match Radiale**

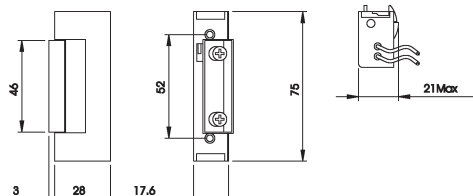

Electric striker without front plate, **FAIL-SAFE VERSION**.

Without hold-open lever.

Voltage: **12V D.C.** Absorption: 0,3A. REVERSIBLE

**040100** B 1 6 6

Voltage: **24V D.C.** Absorption: 0,2A. REVERSIBLE

**040110** C 1 6 6

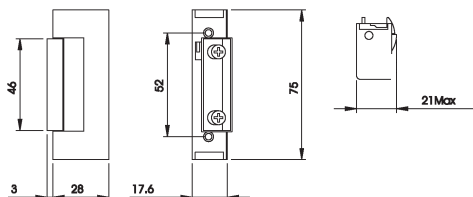

**MECHANICAL** striker without front plate, version **WITHOUT COIL** with hold-open lever. REVERSIBLE.

**040090** D 1 6 6

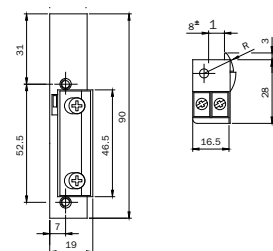

**ADJUSTABLE RIGHT-HAND** electric striker for MULTIBLINDO central striking plates

series 033160-033162-033173-033175. **LIMITED UNLATCHING DURING ELECTRIC PULSE ONLY.**

Hold-open lever. Voltage: **12V A.C. 15W**

**040900** B 1 10 10

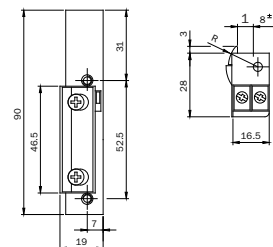

**ADJUSTABLE LEFT-HAND** electric striker for MULTIBLINDO central striking plates

series 033161-033163-033174-033176. **LIMITED UNLATCHING DURING ELECTRIC PULSE ONLY.**

Hold-open lever. Voltage: **12V A.C. 15W**

**040910** B 1 10 10



Code

Status  
Single package  
Multiple package

Min. ord.

**Match Radiale**

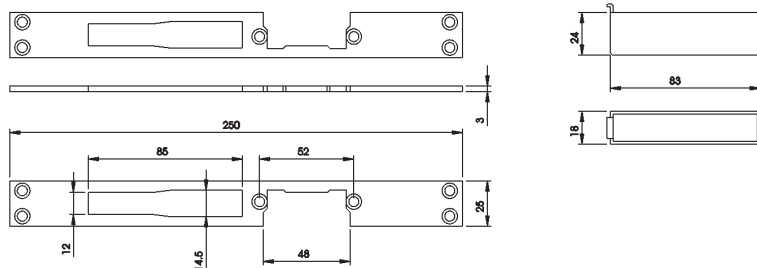

Closed **REVERSIBLE** striking plate, satin STAINLESS STEEL, U-front plate mm **250x25x3**, for locks 78\*-96\*7-96\*9-98. Can be used with electric strikers series 0400\*0 and 0401\*0. With nylon case.

**033190** B 1 10 10

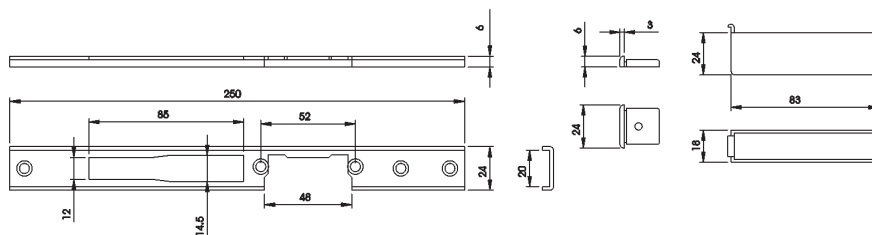

Closed **RIGHT-HAND** striking plate, satin STAINLESS STEEL, U-front plate mm **250x24x6**, for locks 78\*-96\*7-96\*9-98. Can be used with electric strikers series 0400\*0 and 0401\*0. With nylon caps and case.

**033194** C 1 10 10

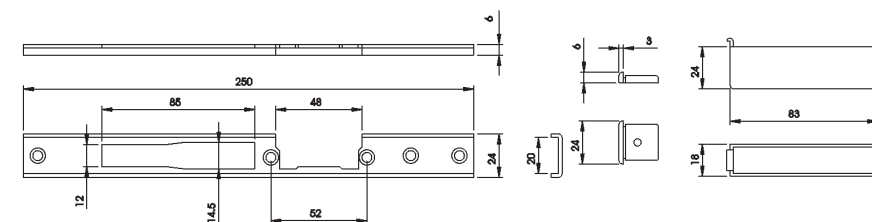

Closed **LEFT-HAND** striking plate, satin STAINLESS STEEL, U-front plate mm **250x24x6**, for locks 78\*-96\*7-96\*9-98. Can be used with electric strikers series 0400\*0 and 0401\*0. With nylon caps and case.

**033195** C 1 10 10

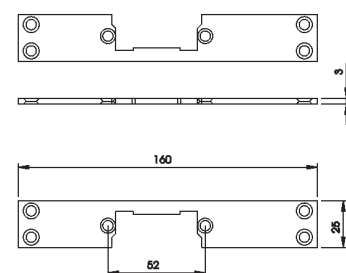

**REVERSIBLE** striking plate in satin STAINLESS STEEL, flat front plate mm **160x25x3**, for locks with latchbolt only. Can be used with electric strikers series 0400\*0 and 0401\*0.

**033196** B 1 10 10



Code

Min. ord.  
Multiple  
package  
Single  
package  
Status

**Match Radiale**

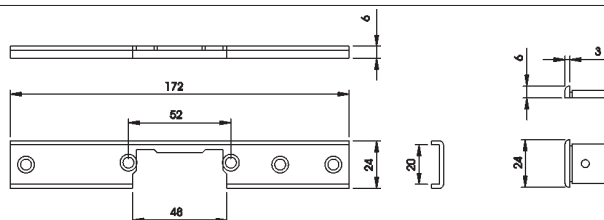

**REVERSIBLE** striking plate in satin STAINLESS STEEL, U-front plate mm **172x24x6**, for locks with deadbolt only. Can be used with electric strikers series 0400\*0 and 0401\*0. With cap.

**033197** D 1 10 10

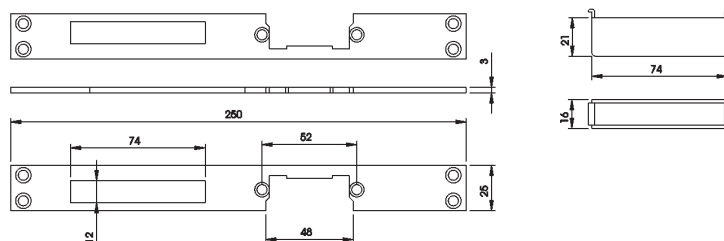

**REVERSIBLE** closed striking plate in satin STAINLESS STEEL, flat front plate mm **250x25x3**, for mortice locks for wooden frames series 200-205-210-215-221-240-250-741-291. Can be used with electric strikers series 0400\*0 and 0401\*0. With nylon case.

**033193** C 1 10 10

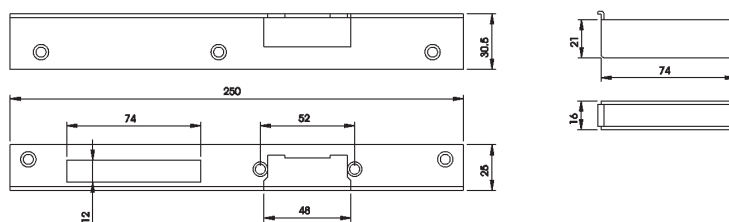

**RIGHT-HAND** closed angle striking plate, GOLD PAINTED steel mm **250x30,5x25**, for mortice locks for wooden frames series 200-205-210-215-221-240-250-741-291. Can be used with electric strikers series 0400\*0 and 0401\*0. With nylon case.

**033191** D 1 10 10

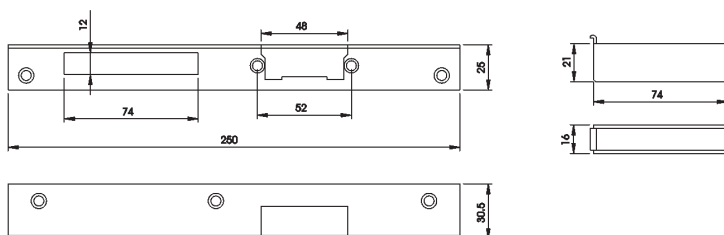

**LEFT-HAND** closed angle striking plate, GOLD PAINTED steel mm **250x30,5x25**, for mortice locks for wooden frames series 200-205-210-215-221-240-250-741-291. Can be used with electric strikers series 0400\*0 and 0401\*0. With nylon case.

**033192** D 1 10 10



Code

Status  
Single package  
Multiple package

Min. ord.

**Match Radiale**

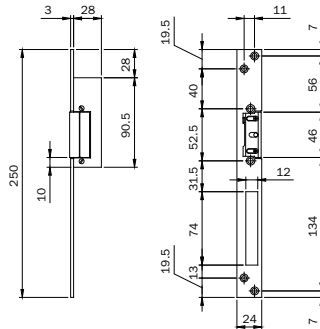

Electric striker with flat front plate, STAINLESS STEEL mm **250x24x3**, **RIGHT- OR LEFT-HAND USE**, for mortice locks with translating latchbolt and deadbolt for aluminium frames, **PERMANENT UNLATCHING AFTER ELECTRIC PULSE**, with hold-open lever pin for automatic function. Voltage: **12V A.C. 15W**

**5621830** A 1 10 10

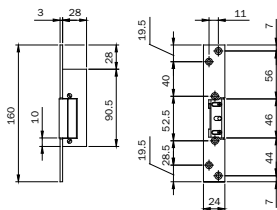

Electric striker with flat front plate, STAINLESS STEEL mm **160x24x3**, **RIGHT- OR LEFT-HAND USE**, for mortice locks for aluminium frames, **PERMANENT UNLATCHING AFTER ELECTRIC PULSE** with hold-open lever, pin for automatic function. Voltage: **12V A.C. 15W**

**5611830** C 1 10 10

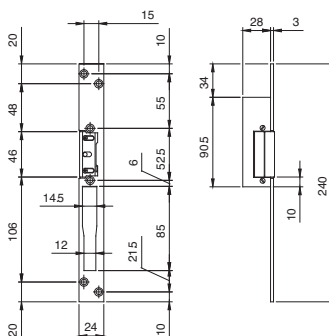

Electric striker with flat front plate, STAINLESS STEEL mm **240x24x3**, for mortice locks with tilting deadbolt and latchbolt for aluminium frames. Can be used on: FRAMES WITH INTERNAL **RIGHT-HAND LOCK**, RAIL FRAMES WITH **LEFT-HAND** INTERNAL LOCK, **PERMANENT UNLATCHING AFTER ELECTRIC PULSE**, with hold-open lever, pin for automatic function.

Power supply **12V. A.C. 15W.**

**5651830** B 1 10 10

Electric striker with flat front plate, STAINLESS STEEL mm **240x24x3**, for mortice locks with tilting deadbolt and latchbolt for aluminium frames. Can be used on: FRAMES WITH INTERNAL **LEFT-HAND LOCK**, RAIL FRAMES WITH **RIGHT-HAND** INTERNAL LOCK, **PERMANENT UNLATCHING AFTER ELECTRIC PULSE**, with hold-open lever, pin for automatic function.

Power supply **12V. A.C. 15W.**

**5661830** B 1 10 10



Code

Min. ord.  
Multiple  
package  
Single  
package  
Status

**Match for metal frames**



Full-size scale

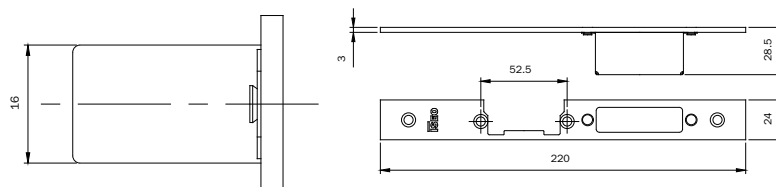

**RIGHT-HAND** striking plate for MULTIBLINDO **CENTRAL LOCK**.

Flat front plate mm **220x24x3** in STAINLESS STEEL. Can be used with striker series: 040890, 040900, 040910, 0400\*0 e 0401\*0. With case.

**033160** B 1 10 10



Full-size scale

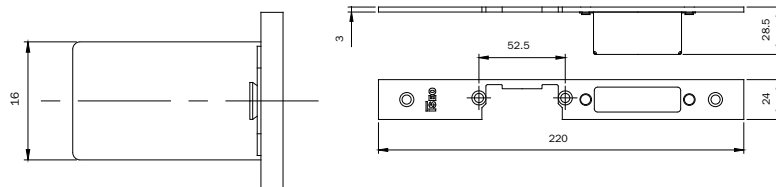

**LEFT-HAND** striking plate for MULTIBLINDO **CENTRAL LOCK**.

Flat front plate mm **220x24x3** in STAINLESS STEEL. Can be used with striker series: 040890, 040900, 040910, 0400\*0 e 0401\*0. With case.

**033161** C 1 10 10

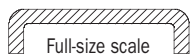

Full-size scale

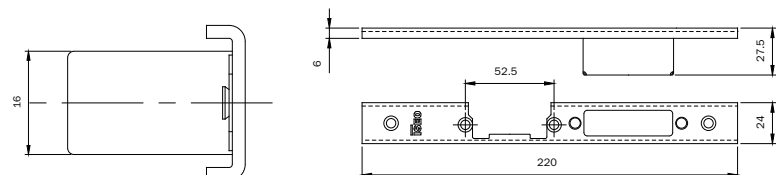

**RIGHT-HAND** striking plate for MULTIBLINDO **CENTRAL LOCK**.

U-front plate mm **220x24x6** in STAINLESS STEEL. Can be used with striker series: 040890, 040900, 040910, 0400\*0 e 0401\*0. With caps and case.

**033162** B 1 10 10

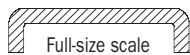

Full-size scale

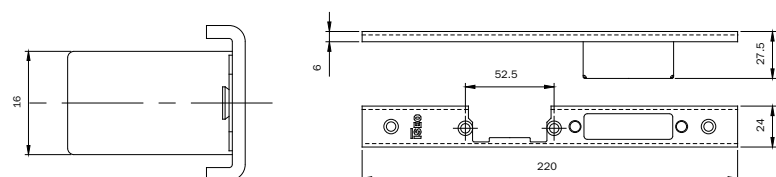

**LEFT-HAND** striking plate for MULTIBLINDO **CENTRAL LOCK**.

U-front plate mm **220x24x6** in STAINLESS STEEL. Can be used with striker series: 040890, 040900, 040910, 0400\*0 and 0401\*0. With caps and case.

**033163** B 1 10 10



Full-size scale

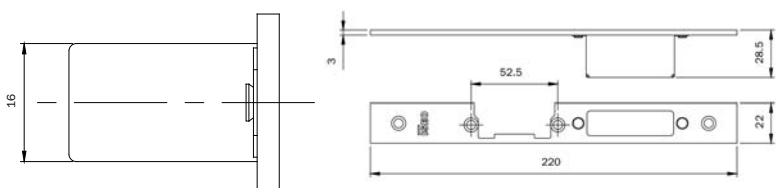

**RIGHT-HAND** striking plate for MULTIBLINDO **CENTRAL LOCK**.

Flat front plate mm **220x22x3** in STAINLESS STEEL. Can be used with strikers series: 040890, 040900, 040910, 0400\*0 and 0401\*0. With case.

**033173** D 1 10 10





Code

Min. ord.  
Multiple  
package  
Single  
package  
Status

**Match** for metal frames

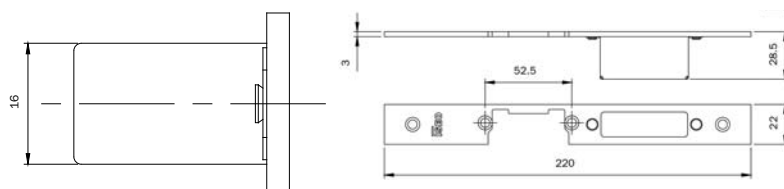
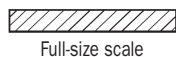

**LEFT-HAND** striking plate for MULTIBLINDO **CENTRAL LOCK**.

Flat front plate mm **220x22x3** in STAINLESS STEEL. Can be used with strikers series: 040890, 040900, 040910, 0400\*0 e 0401\*0. With case.

**033174** D 1 10 10

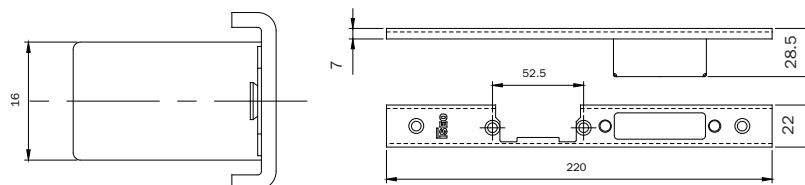
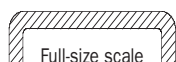

**RIGHT-HAND** striking plate for MULTIBLINDO **CENTRAL LOCK**.

U-front plate mm **220x22x7** in STAINLESS STEEL. Can be used with strikers series: 040890, 040900, 040910, 0400\*0 and 0401\*0. With caps and case.

**033175** D 1 10 10

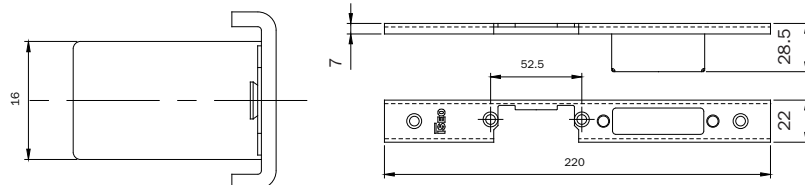
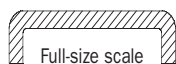

**LEFT-HAND** striking plate for MULTIBLINDO **CENTRAL LOCK**.

U-front plate mm **220x22x7** in STAINLESS STEEL. Can be used with strikers series: 040890, 040900, 040910, 0400\*0 and 0401\*0. With caps and case.

**033176** C 1 10 10

**Striking  
plates  
for multipoint  
and mortice  
locks**





Code

Min. ord.  
Multiple package  
Single package  
Status

**Adjustable closed striking plates**

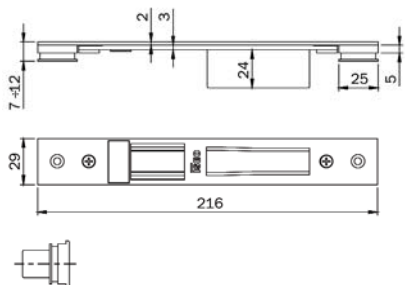
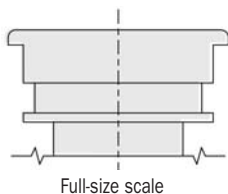

- ALCAN abithal Keeper Porta 53/60 / Abithal Keeper Porta 61/68 Abithal Porta / Winner Porta
- ALCOA fb 12 Blindato / Formula F40 Porta / Formula F40 Tl Porta Formula F50 Porta / Formula F50 Tl Porta / Formula F60 Tl Porta Plana 1 Anta / Plana 2 Anta
- ALLCO all.Co 5 Porta / All.Co 5 Tl Porta / Export 50 Porta Export 50 Tl Porta / Sicurblin 65
- ALNOR montreal Porta
- ALU-K alublindo / N 45 Porta / N 53 Porta / N 55 Tl Porta N 62 Tl Porta
- ALU-MEC synthesis 57 Porta / Synthesis 60Tl Porta
- ALUSUSSE elsec 2000 Porta 59 / Aisec 2000 Porta 69
- BODEGA extrablind 70
- DOMAL domal Break 52 Porta / Domal Break 70 Porta Domal Security Porta / Domal Shops Porta / Domal Stopper Pg Porta
- ESA blindal 60 Porta 1 Anta / Blindal 60 Porta 2 Anta Blindal 70 Porta 1 Anta / Blindal 70 Porta 2 Anta
- FRESIA global 48 Porta
- INDINVEST alpha 445 Porta 2 Ante
- METRA nc 45 International Porta / Nc 45 Superthermic Porta Nc 55 International Porta / Nc 68 Superthermic Porta Nuovo Nc 50 Porta / Superblindo
- NEW TEC new Tec 50 Porta Complanare
- New Tec 52 Tl Porta Complanare / New Tec 68 Tl Porta Complanare
- OCMA tc 60 Tl Porta / Sv 47 Porta 1 Anta / Sv 47 Porta 2 Anta Sv 62 Porta 1 Anta / Sv 62 Porta 2 Anta / Sv 62 Tl Porta 1 Anta Sv 62 Tl Porta 2 Anta
- PASSERINI ekip Blindo / Ekip Maastricht 53 Porta 1 Anta Ekip Maastricht 53 Porta 2 Anta / Ekip Maastricht Th 60 Porta 1 Anta Ekip Maastricht Th 60 Porta 2 Anta / Ekip Maastricht Th 68 Porta 1 Anta Ekip Maastricht Th 68 Porta 2 Anta / Ekip Thermo 53 Porta
- PROFILATI "Pe" "Eku 53" Porta "Pe" "Eku 64 Tl" Porta "Pe" "Eku 72 Tl" Porta
- SCHILCO royal 78 St Blindato / Royal S 50 N / Royal S 55 Tl Royal S 65 Tl
- WICONA I60A / L70A

**ADJUSTABLE** closed striking plate for **CENTRAL LOCK**

MULTIBLINDO, all versions, and series 78\* - 79\*.

Material: black-painted steel. Flat front plate **216x29** with vertical adjustment from mm 7 to 12 and horizontal adjustment  $\pm$  mm 2.

0386001 A 10 - 10

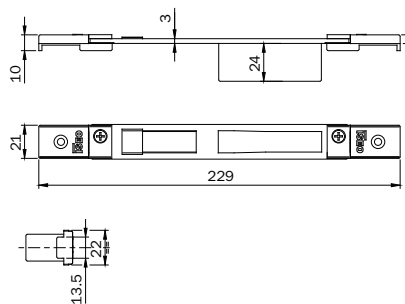
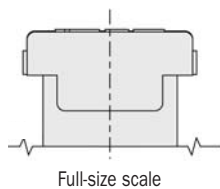

- ALCAN abithal Cristal / Abithal Keeper Porta C.E. / Winner Finestra
- ALCOA fb 12 Ga / Europa Ga / Fb 12 Tl.T. / R 35 Reversibile R 35 Sormonto
- ALLCO export 40 Finestra / Export 45 Tl Finestra / Export 50 Finestra Export 50 Tl Finestra / Final 40 Finestra / Sicurblin C.E.
- ALU-MEC synthesis 45 Finestra / Synthesis 57 Finestra Synthesis 60 Tl Finestra
- ALUSUSSE elsec 2000 Finestra 59 / Aisec 2000 Finestra 69
- BODEGA lga 50 / New Bt 60
- DOMAL domal Break 52 Finestra / Domal Break 70 Finestra Domal Stopper Pg Finestra
- EQUIPE sistema 8000 G.A. Finestra 1 Anta Sistema 8000 G.A. Finestra 2 Anta / Sistema 8000 Tl Finestra 1 Anta Sistema 8000 Tl Finestra 2 Anta
- ESA isola Porta
- ESEDRA ga 53 Porta / Tl 63 Porta / Tl 75 Porta
- INDINVEST gold 400 Complanare / Gold 400 Sormonto Gold 500 Complanare / Gold 500 Sormonto / Gold 600 Complanare Gold 600 Sormonto
- METRA nc 45 International Finestra / Nc 45 Superthermic Finestra Nc 55 International Finestra / Nc 68 Superthermic Finestra Nuovo Nc 40 Sorm. 2 Ante Con Riporto / Nuovo Nc 40 Sormonto 1 Anta
- MORELLI ima 8300
- OCMA tc 47 Finestra / Fo 55 Finestra / Fo 60 Tl Finestra
- PASSERINI ekip 40 Evoluzione 1 Anta / Ekip 40 Evoluzione 2 Anta Ekip 40 Sormonto 1 Anta / Ekip 40 Sormonto 2 Anta Ekip Maastricht 53 Finestra / Ekip Maastricht Th 60 Finestra Ekip Maastricht Th 68 Finestra
- PROFILATI "Pe" "Eku 53" Finestra / "Pe" "Eku 64 Tl" Finestra "Pe" "Eku 72 Tl" Finestra / Sistema 1 Pe 40 Comp./Est. 1 Anta Sistema 1 Pe 40 Sormonto 1 Anta / Sistema 1 Pe 50 Comp./Est. 1 Anta Sistema 1 Pe 50 Sormonto 1 Anta

**ADJUSTABLE** closed striking plate for **CENTRAL LOCK**

MULTIBLINDO, all versions, and series 78\* - 79\*.

Material: black-painted steel. Flat front plate **229x22** with vertical adjustment through threaded plates and horizontal adjustment  $\pm$  mm 9.

0386011 A 10 - 10



Code

Min. ord.  
Multiple  
package  
Single  
package  
Status

**Adjustable closed striking plates**

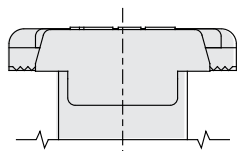

Full-size scale

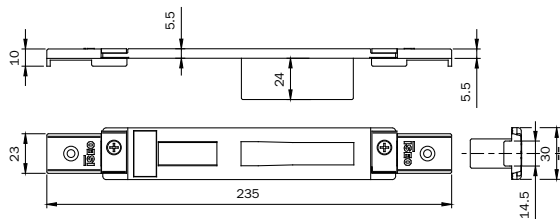

**ALCOA** alublind / R 40 Reversibile 1 Anta / R 40 Reversibile 2 Ante  
R 40 Sormonto 1 Anta / R 40 Sormonto 2 Ante  
R 50 Sormonto 1 Anta / R 50 Sormonto 2 Ante  
R 50 Tt Sormonto 1 Anta / R 50 Tt Sormonto 2 Ante  
R 60 Tt Complanare  
**ALLCO** all.Co 5 Reversibile / All.Co 5 Sormonto / Ites P4 Sormonto  
**ALU-K** n 45 Reversibile  
**ESA** giuntali Porta  
**FRESIA** global 41 Complanare / Global 41 Sormonto  
Global 48 Complanare / Global 48 Sormonto / Global 70 Taglio Termico  
**METRA** nuovo Nc 50 Sormonto 1 Anta / Nuovo Nc 50 Sormonto 2 Ante  
New Tecnew Tec 50 Porta Sormonto / New Tec 52 Tt Porta Sormonto  
New Tec 60 Tt Porta Sormonto / New Tec 68 Tt Porta Sormonto  
**PASSERINI** ekip 50 Sormonto 1 Anta / Ekip 50 Sormonto 2 Ante

**ADJUSTABLE** closed striking plate for **CENTRAL LOCK**

MULTIBLINDO, all versions, and series 78\* - 79\*.

Material: BLACK-painted steel. Flat front plate **235x30** with horizontal adjustment  $\pm$  mm 9.

**0386021** A 10 - 10

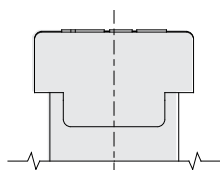

Full-size scale

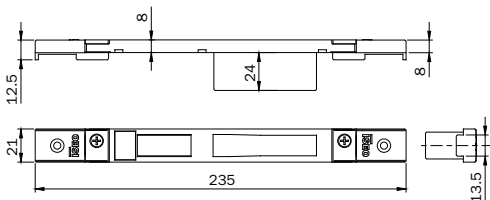

**ALLCO** all.Co 5 Complanare / Ites P4 Complanare  
**ALNOR** blindo Block / Montreal G.A.  
**ALU-K** n 53 Complanare / N 55 Tt Complanare  
**ESA** giuntali Complanare  
**INDINVEST** alpha 255 Complanare / Alpha 370 Tt Complanare  
Alpha 445 Finestra / Alpha 445 Porta 1 Anta  
Alpha 658 Tt Complanare / Alpha Blitz 2000  
Alpha Globo 45 / Alpha Globo 55  
**METRA** nuovo Nc 40 Complanare / Nuovo Nc 40 Sormonto 2 Ante  
Nuovo Nc 50 Complanare  
**PASSERINI** ekip 40 Complanare 1 Anta / Ekip 40 Complanare 2 Ante  
Ekip 50 Complanare 1 Anta / Ekip 50 Complanare 2 Ante  
Ekip Thermo 53 Finestra 1 Anta / Ekip Thermo 53 Finestra 2 Ante  
Ekip Thermo 58 Finestra 1 Anta / Ekip Thermo 58 Finestra 2 Ante  
**PROFILATI** sistema 1 Pe 40 Comp./Est. 2 Ante  
Sistema 1 Pe 40 Sormonto 2 Ante / Sistema 1 Pe 50 Comp./Est. 2 Ante  
Sistema 1 Pe 50 Sormonto 2 Ante

**ADJUSTABLE** closed striking plate for **CENTRAL LOCK**

MULTIBLINDO, all versions, and series 78\* - 79\*.

Material: BLACK-painted steel. Flat front plate **235x21** with horizontal adjustment  $\pm$  mm 9.

**0386031** B 10 - 10

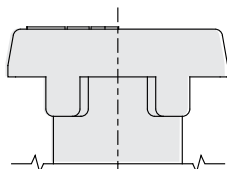

Full-size scale

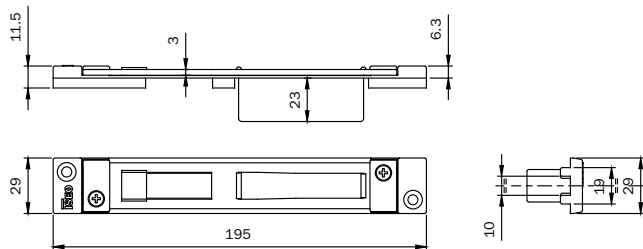

**ALCOA** alublind / R 40 Reversibile 1 Anta / R 40 Reversibile 2 Ante  
R 40 Sormonto 1 Anta / R 40 Sormonto 2 Ante  
R 50 Sormonto 1 Anta / R 50 Sormonto 2 Ante  
R 50 Tt Sormonto 1 Anta / R 50 Tt Sormonto 2 Ante  
R 60 Tt Complanare

**ADJUSTABLE** closed striking plate for **CENTRAL LOCK**

MULTIBLINDO, all versions, and series 78\* - 79\*.

Material: BLACK-painted steel. Flat front plate **195x29** with horizontal adjustment  $\pm$  mm 13.

**0386041** A 10 - 10



Code

Min. ord.  
Multiple package  
Single package  
Status

**Adjustable closed striking plates**

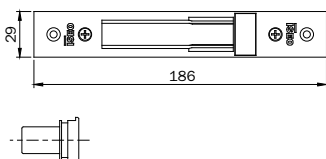
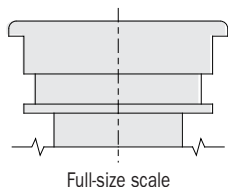

**ADJUSTABLE** closed striking plate for **LOCK**  
**WITH ONLY DEADBOLTS AND DEVIATORS** MULTIBLINDO  
series 78\* - 96\* - 98\* 550 - 551 - 556 - 70\* - 71\* - 730\*  
731\* - 736 - 737. Material: BLACK-painted steel. Flat front plate  
**186x29** with vertical adjustment mm 7 to 12  
and horizontal adjustment  $\pm$  mm 2.

- ALCAN abithal Keeper Porta 53-60 / Abithal Keeper Porta 61-68
- Abithal Porta / Winner Porta
- ALCOA Ito 12 Blindato / Formula F40 Porta / Formula F40 Tl Porta
- Formula F50 Porta / Formula F50 Tl Porta / Formula F60 Tl Porta
- Plana 1 Ante / Plana 2 Ante
- ALLCO all Co 5 Porta / All.Co 5 Tl Porta / Export 50 Porta
- Export 50 Tl Porta / Sicurblin 65
- ALNOR montreal Porta
- ALL-K alubindo / N 45 Porta / N 53 Porta / N 55 Tl Porta
- N 62 Tl Porta
- ALU-MEC synthesis 57 Porta / Synthesis 60Tl Porta
- ALUSUSSE alesc 2000 Porta 59 / Alesc 2000 Porta 69
- BODEGA extrablind 70
- DOMAL domal Break 52 Porta / Domal Break 70 Porta
- Domal Security Porta / Domal Shaps Porta / Domal Stopper Pg Porta
- ESA blindal 60 Porta 1 Ante / Blindal 60 Porta 2 Ante
- Blindal 70 Porta 1 Ante / Blindal 70 Porta 2 Ante
- FRESIA global 48 Porta
- INDIVEST alpha 445 Porta 2 Ante
- METRA nc 45 International Porta / Nc 45 Superthermic Porta
- Nc 55 International Porta / Nc 68 Superthermic Porta
- Nuovo Nc 50 Porta / Superblindo
- NEW TEC new Tec 50 Porta Complanare
- New Tec 52 Tl Porta Complanare / New Tec 68 Tl Porta Complanare
- OCMAIc 60 Tl Porta / Sv 47 Porta 1 Ante / Sv 47 Porta 2 Ante
- Sv 62 Porta 1 Ante / Sv 62 Porta 2 Ante / Sv 62 Tl Porta 1 Ante
- Sv 62 Tl Porta 2 Ante
- PASSERINI ekip Blindo / Ekip Maastricht 53 Porta 1 Ante
- Ekip Maastricht 53 Porta 2 Ante / Ekip Maastricht Th 60 Porta 1 Ante
- Ekip Maastricht Th 60 Porta 2 Ante / Ekip Maastricht Th 68 Porta 1 Ante
- Ekip Maastricht Th 68 Porta 2 Ante / Ekip Thermo 53 Porta
- PROFILATI "Pe "Eku 53" Porta"
- "Pe "Eku 64 Tl" Porta"
- "Pe "Eku 72 Tl" Porta"
- SCHUCO royal 78 St Blindato / Royal S 50 N / Royal S 55 Tl
- Royal S 65 Tl
- WICONA 60A / L70A

0387001 A 10 - 10

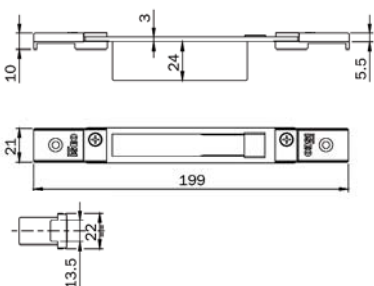
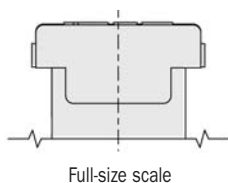

**ADJUSTABLE** closed striking plate for **LOCK**  
**WITH ONLY DEADBOLTS AND DEVIATORS** MULTIBLINDO  
series 78\* - 96\* 98\* - 550 - 551 - 556 - 70\* - 71\* - 730\*  
731\* - 736 - 737. Material: BLACK-painted steel. Flat front plate  
**199x22** with vertical adjustment through threaded plates  
and horizontal adjustment  $\pm$  mm 9.

- ALCAN abithal Cristal / Abithal Keeper Porta C.E. / Winner Finestra
- ALCOA Ito 12 Ga / Europa Ga / Fb 12 T.T. / R 35 Reversible
- R 35 Sormonto
- ALLCO export 40 Finestra / Export 45 Tl Finestra / Export 50 Finestra
- Export 50 Tl Finestra / Final 40 Finestra / Sicurblin C.E.
- ALU-MEC synthesis 45 Finestra / Synthesis 57 Finestra
- Synthesis 60 Tl Finestra
- ALUSUSSE alesc 2000 Finestra 59 / Alesc 2000 Finestra 69
- BODEGA lga 50 / New Bt 60
- DOMAL domal Break 52 Finestra / Domal Break 70 Finestra
- Domal Stopper Pg Finestra
- EQUIPE sistema 8000 G.A. Finestra 1 Ante
- Sistema 8000 G.A. Finestra 2 Ante / Sistema 8000 Tl Finestra 1 Ante
- Sistema 8000 Tl Finestra 2 Ante
- ESA isola Porta
- ESDRA ga 53 Porta / Tl 63 Porta / Tl 75 Porta
- INDIVEST gold 400 Complanare / Gold 400 Sormonto
- Gold 500 Complanare / Gold 500 Sormonto / Gold 600 Complanare
- Gold 600 Sormonto
- METRA nc 45 International Finestra / Nc 45 Superthermic Finestra
- Nc 55 International Finestra / Nc 68 Superthermic Finestra
- Nuovo Nc 40 Sorm. 2 Ante Con Riporto / Nuovo Nc 40 Sormonto 1 Ante
- MORELLI ma 8300
- OCMA Ic 47 Finestra / Fc 55 Finestra / Fc 60 Tl Finestra
- PASSERINI ekip 40 Evoluzione 1 Ante / Ekip 40 Evoluzione 2 Ante
- Ekip 40 Sormonto 1 Ante / Ekip 40 Sormonto 2 Ante
- Ekip Maastricht 53 Finestra / Ekip Maastricht Th 60 Finestra
- Ekip Maastricht Th 68 Finestra
- PROFILATI "Pe "Eku 53" Finestra" / "Pe "Eku 64 Tl" Finestra"
- "Pe "Eku 72 Tl" Finestra" / Sistema 1 Pe 40 Comp./Est. 1 Ante
- Sistema 1 Pe 40 Sormonto 1 Ante / Sistema 1 Pe 50 Comp./Est. 1 Ante
- Sistema 1 Pe 50 Sormonto 1 Ante

0387011 A 10 - 10

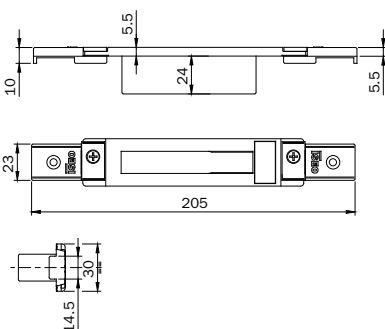
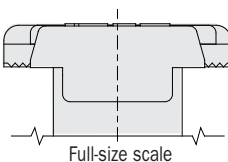

**ADJUSTABLE** closed striking plate for **LOCK**  
**WITH ONLY DEADBOLTS AND DEVIATORS** MULTIBLINDO  
series 78\* - 96\* 98\* - 550 - 551 - 556 - 70\* - 71\* - 730\*  
731\* - 736 - 737. Material: BLACK-painted steel. Flat front plate **205x30**  
with horizontal adjustment  $\pm$  mm 9.

- ALCOA alubind / R 40 Reversible 1 Ante / R 40 Reversible 2 Ante
- R 40 Sormonto 1 Ante / R 40 Sormonto 2 Ante
- R 50 Sormonto 1 Ante / R 50 Sormonto 2 Ante
- R 50 Tl Sormonto 1 Ante / R 50 Tl Sormonto 2 Ante
- R 60 Tl Complanare
- ALLCO all Co 5 Reversible / All.Co 5 Sormonto / Ites P4 Sormonto
- ALL-K n 45 Reversible
- ESA giuntall Porta
- FRESIA global 41 Complanare / Global 41 Sormonto
- Global 48 Complanare / Global 48 Sormonto / Global 70 Taglio Termico
- METRA nuovo Nc 50 Sormonto 1 Ante / Nuovo Nc 50 Sormonto 2 Ante
- New Tecnew Tec 50 Porta Sormonto / New Tec 52 Tl Porta Sormonto
- New Tec 60 Tl Porta Sormonto / New Tec 68 Tl Porta Sormonto
- PASSERINI ekip 50 Sormonto 1 Ante / Ekip 50 Sormonto 2 Ante

0387021 A 10 - 10



Code

Min. ord.  
Multiple  
package  
Single  
package  
Status

**Adjustable closed striking plates**

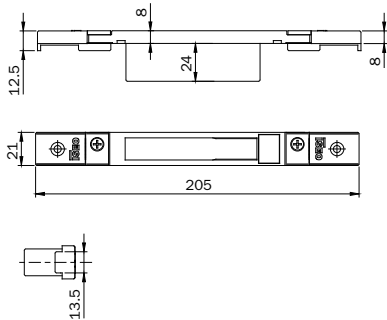
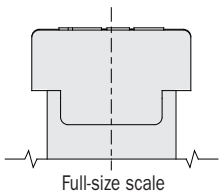

ALLCO all.Co 5 Complanare / Ites P4 Complanare  
ALNOR blindo Block / Montreal G.A.  
ALU-K n 53 Complanare / N 55 Tt Complanare  
ESA giuntali Complanare  
INDINVEST alpha 235 Complanare / Alpha 370 Tt Complanare  
Alpha 445 Finestra / Alpha 445 Porta 1 Ante  
Alpha 658 Tt Complanare / Alpha Blitz 2000  
Alpha Globo 45 / Alpha Globo 55  
METRA nuovo Nc 40 Complanare / Nuovo Nc 40 Sormonto 2 Ante  
Nuovo Nc 50 Complanare  
PASSERINI ekip 40 Complanare 1 Ante / Ekip 40 Complanare 2 Ante  
Ekip 50 Complanare 1 Ante / Ekip 50 Complanare 2 Ante  
Ekip Thermo 53 Finestra 1 Ante / Ekip Thermo 53 Finestra 2 Ante  
Ekip Thermo 58 Finestra 1 Ante / Ekip Thermo 58 Finestra 2 Ante  
PROFILATI sistema 1 Pe 40 Comp./Est. 2 Ante  
Sistema 1 Pe 40 Sormonto 2 Ante / Sistema 1 Pe 50 Comp./Est. 2 Ante  
Sistema 1 Pe 50 Sormonto 2 Ante

**ADJUSTABLE** closed striking plate for **LOCK**  
**WITH ONLY DEADBOLTS AND DEVIATORS** MULTIBLINDO series 78\* - 96\* - 98\*  
550 - 551 - 556 - 70\* - 71\* - 730\* - 731\* - 736 - 737.  
Material: BLACK-painted steel. Flat front plate **205x21**  
with horizontal adjustment  $\pm$  mm 9.

**0387031** B 10 - 10

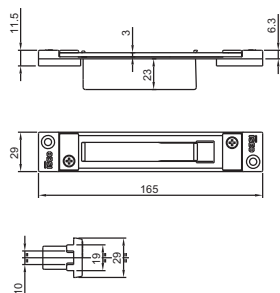
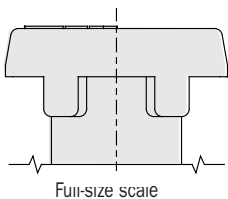

ALCOA alublind / R 40 Reversibile 1 Ante / R 40 Reversibile 2 Ante  
R 40 Sormonto 1 Ante / R 40 Sormonto 2 Ante  
R 50 Sormonto 1 Ante / R 50 Sormonto 2 Ante  
R 50 Tt Sormonto 1 Ante / R 50 Tt Sormonto 2 Ante  
R 60 Tt Complanare

**ADJUSTABLE** closed striking plate for **LOCK**  
**WITH ONLY DEADBOLTS AND DEVIATORS** MULTIBLINDO series 78\* - 96\* - 98\*  
550 - 551 - 556 - 70\* - 71\* - 730\* - 731\* - 736 - 737.  
Material: BLACK-painted steel. Flat front plate **165x29**  
with horizontal adjustment  $\pm$  mm 13.

**0387041** A 10 - 10

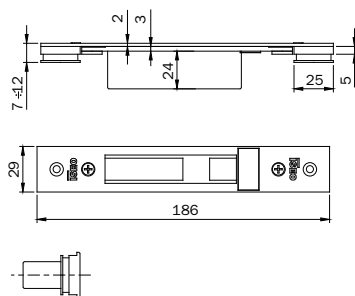
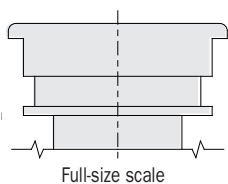

ALCAN alibthal Keeper Porta 5360 / Alibthal Keeper Porta 6168  
Alibthal Porta / Wimper Porta  
ALCOA fb 12 Blindato / Formula F40 Porta / Formula F40 Tt Porta  
Formula F50 Porta / Formula F50 Tt Porta / Formula F60 Tt Porta  
Plana 1 Ante / Plana 2 Ante  
ALLCO all.Co 5 Porta / All.Co 5 Tt Porta / Export 50 Porta  
Export 50 Tt Porta / Sicurbiln 65  
ALNOR montreal Porta  
ALU-K alublindo / N 45 Porta / N 53 Porta / N 55 Tt Porta / N 62 Tt  
Porta  
ALU-MEC synthesis 57 Porta / Synthesis 60Tt Porta  
ALUSUSSE alsec 2000 Porta 59 / Alsec 2000 Porta 69  
BODEGA extrablind 70  
DOMAL domal Break 52 Porta / Domal Break 70 Porta  
Domal Security Porta / Domal Shops Porta / Domal Stopper Pg Porta  
ESA blindal 60 Porta 1 Ante / Blindal 60 Porta 2 Ante  
Blindal 70 Porta 1 Ante / Blindal 70 Porta 2 Ante  
FRESIA global 48 Porta  
INDINVEST alpha 445 Porta 2 Ante  
METRA nc 45 International Porta / Nc 45 Superthermic Porta  
Nc 55 International Porta / Nc 68 Superthermic Porta / Nuovo Nc 50  
Porta / Superblindo  
NEW TEC new Tec 50 Porta Complanare  
New Tec 52 Tt Porta Complanare / New Tec 68 Tt Porta Complanare  
ODMA Sv 47 / 62 / 62 Tt Porta 1 Ante / 2 Ante / FG 60 Tt Porta  
PASSERINI ekip Blindo / Ekip Maastricht 53 Porta 1 Ante  
Ekip Maastricht 53 Porta 2 Ante / Ekip Maastricht Th 60 Porta 1 Ante  
Ekip Maastricht Th 60 Porta 2 Ante / Ekip Maastricht Th 68 Porta 1 Ante  
Ekip Maastricht Th 68 Porta 2 Ante / Ekip Thermo 53 Porta  
PROFILATI "Pe "Eku 53" Porta" / "Pe "Eku 64 Tt" Porta"  
"Pe "Eku 72 Tt" Porta"  
SCHÜCO royal 78 St Blindato / Royal S 50 N / Royal S 55 Tt  
Royal S 65 Tt  
WICONA L60A / L70A

**ADJUSTABLE** closed striking plate for **HOOK DEVIATORS**  
MULTIBLINDO. Material: BLACK-painted steel. Flat front plate  
**186x29** with vertical adjustment from mm 7 to 12  
horizontal adjustment  $\pm$  mm 2.

**038710** B 10 - 1



Code

Min. ord.  
Multiple  
package  
Single  
package  
Status

**Adjustable closed striking plates**

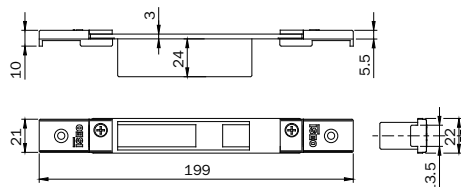
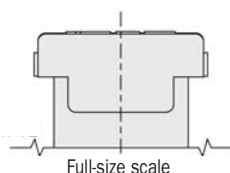

ALCAN abithal Cristal / Abithal Keeper Porta C.E. / Winner Finestra  
ALCOA Rb 12 GA / Europa GA / Fb 12 Tt / R35 Reversibile  
R35 Sormonto  
ALICO support 40 / 45Tt / 50 / 50 Tt Finestra / Final 40 Finestra  
Scrublin C.E.  
ALU-MEC synthesis 45 / 57 / 60 Tt Finestra  
ALUSUISSE alicec 2000 Finestra 59 / 69  
BODEGA bga 50 / New Bt 60  
DOMAL domal Break 52 / 70 Finestra  
Domal Stopper Pg Finestra  
EQUIPE sistema 8000 G.A. Finestra 1 Anta  
Sistema 8000 G.A. Finestra 2 ante  
ESA isola porta  
ESEDRA g.a. 53 Porta / Tt 63 Porta / Tt 65 Porta  
INDINVEST gold 400 Complanare / Gold 400 Sormonto / Gold 500  
Complanare / Gold 500 Sormonto / Gold 600 Complanare / Gold 600  
Sormonto  
METRA nc 45 International Finestra / Nc 45 Superthermic Finestra  
Nc 55 International Finestra / Nc 68 Superthermic Finestra / Nuovo Nc  
40 Sormonto 2 Ante con Riporto / Nuovo Nc 40 Sormonto 1 Anta  
Porta / Superblindo  
MORELLI ma 8300  
OCMA fc 47 Finestra / Fc 55 Finestra / Fc 60 Tt Finestra  
PASSERINI Ekip 40 Evoluzione 1 Anta / Ekip 40 Sormonto 1 Anta  
Ekip 40 Sormonto 2 Ante / Ekip Maastricht 53 Finestra / Ekip Maastricht  
Tt 60 Finestra / Ekip Maastricht Tt 68 Finestra  
PROFILATI Pe "Eku 53" Finestra / Pe "Eku 64 Tt" Finestra  
"Pe" "Eku 72 Tt" Finestra / Sistema Pe 1 40 Comp./Est. 1 Anta  
Sistema Pe 1 40 Sormonto 1 Anta / Sistema Pe 1 50 Comp./Est. 1 Anta  
Sistema Pe 1 50 Sormonto 1 Anta

**ADJUSTABLE** closed striking plate for **HOOK DEVIATORS**  
MULTIBLINDO. Material: BLACK-painted steel. Flat front plate  
**197x21** with vertical adjustment through threaded plates  
and horizontal adjustment  $\pm$  mm 9.

**038711** B 10 - 1

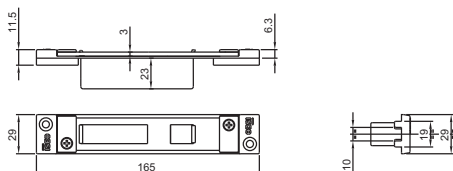
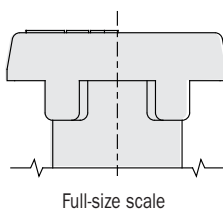

ALCOA alublind / R 40 Reversibile 1 Anta / R 40 Reversibile 2 Anta  
R 40 Sormonto 1 Anta / R 40 Sormonto 2 Anta  
R 50 Sormonto 1 Anta / R 50 Sormonto 2 Anta  
R 50 Tt Sormonto 1 Anta / R 50 Tt Sormonto 2 Anta  
R 60 Tt Complanare

**ADJUSTABLE** closed striking plate for **HOOK DEVIATORS**  
MULTIBLINDO. Material: BLACK-painted steel. Flat front plate  
**165x29** horizontal adjustment  $\pm$  mm 13.

**038712** B 10 - 1

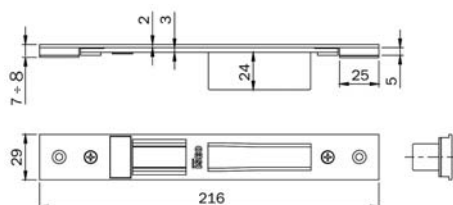
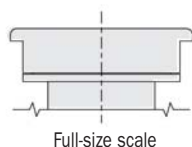

ALUMAFEL

**ADJUSTABLE** closed striking plate for **CENTRAL LOCK** MULTIBLINDO,  
for 78\* - 79\* series. Material: BLACK-painted steel. Flat front plate **216x29**  
with vertical adjustment from mm 7 to 8 and horizontal adjustment  $\pm$  mm 1

**0386002** D 10 -

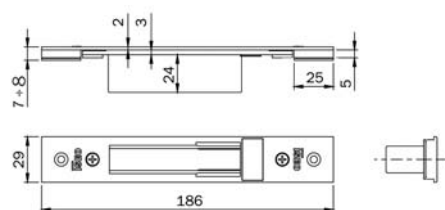
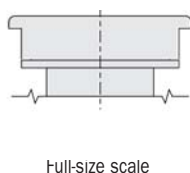

ALUMAFEL

**ADJUSTABLE** closed striking plate for **LOCK DEADBOLTS ONLY AND DEVIATORS** MULTIBLINDO  
78\* - 96\* - 98\* - 550 - 551 - 556 - 70\* - 71\* - 730\* - 731\* - 736 - 737 series.  
Material: BLACK-painted steel. Flat front plate **186x29** with vertical adjustment from mm 7 a 12  
and horizontal adjustmen  $\pm$  mm 2.

**0387002** D 10 - 1



Code

Status  
Single  
package

Min. ord.

**For multi point locks**

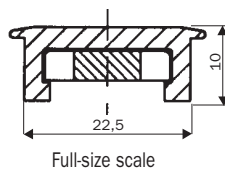
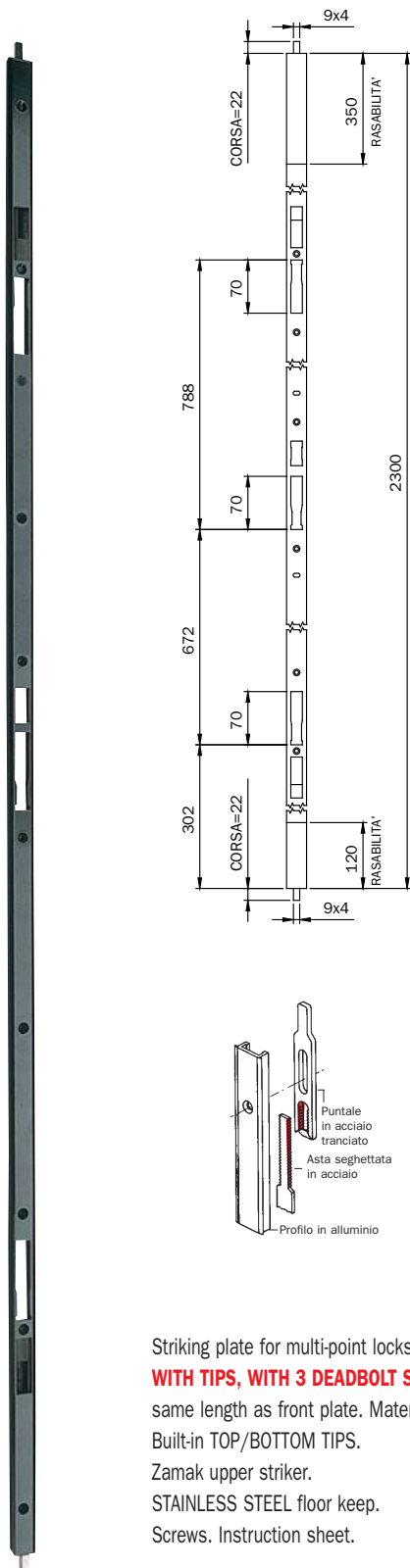

- ALCAN: WINNER PORTA
- ALL.CO: ALL.CO 5 PORTA  
ALL.CO 5 TT PORTA  
SICURBLIN 65
- FINAL: EXPORT 50 PORTA
- ALNOR: MONTREAL PORTA
- ALU. K: ALUBLINDO  
N 45 PORTA  
N 53 PORTA
- ALU-MEC: SYNTHESIS 57 PORTA  
SYNTHESIS 60TT PORTA
- DOMAL: DOMAL SECURITY  
DOMAL STOPPER PG PORTA
- METRA: NC 45 INTERNATIONAL PORTA  
NC 55 INTERNATIONAL PORTA  
NC 68 SUPERHERMIC PORTA  
NUOVO NC 50 PORTA  
SUPERBLINDO
- SCHÜCO: ROYAL 78 ST BLINDATO
- PASSERINI: EKIP THERMO 53 PORTA

Black-painted  
aluminium  
22,5X10 mm

038070 C 1 - 1

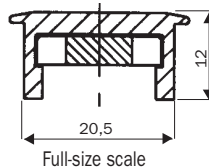
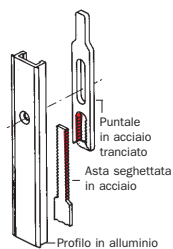

- ALCAN: HABITAT PORTA
- ALCOA: F40 PORTA  
F40 TT PORTA  
F50 PORTA  
F50 TT PORTA  
F60 TT PORTA
- ALUSUISSE: ALSEC 2000 PORTA 59  
ALSEC 2000 PORTA 69
- BODEGA: EXTRABLIND 70
- DOMAL: DOMAL BREAK 52 PORTA  
DOMAL BREAK 70 PORTA  
DOMAL SHOPS
- NEW-TEC: NEW-TEC 52 PORTA COMP.  
NEW-TEC 68 PORTA COMP.
- OCMA: SV 47 PORTA 1 ANTA  
SV 62 PORTA 1 ANTA  
SV 62 TT PORTA

Black-painted  
aluminium  
20,5X12 mm

038071 D 1 - 1

Striking plate for multi-point locks, **FOR TWO-WINGED DOORS WITH TIPS, WITH 3 DEADBOLT SEATS**, same length as front plate. Material: BLACK-painted ALUMINIUM  
Built-in TOP/BOTTOM TIPS.  
Zamak upper striker.  
STAINLESS STEEL floor keep.  
Screws. Instruction sheet.





Code

Min. ord.  
Multiple  
package  
Single  
package  
Status

**For multi point locks**

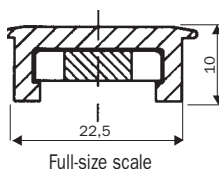
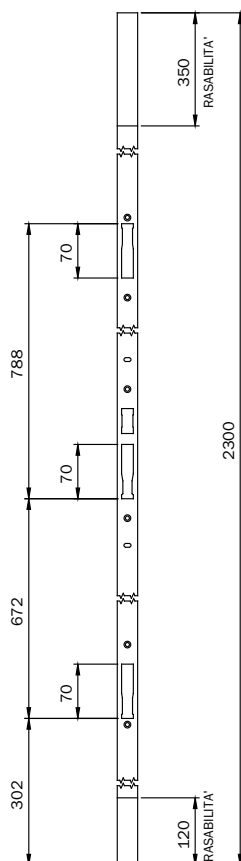

- ALCAN: WINNER PORTA
- ALL.CO: ALL.CO 5 PORTA  
ALL.CO 5 TT PORTA  
SICURBLIN 65
- FINAL: EXPORT 50 PORTA
- ALNOR: MONTREAL PORTA
- ALU. K: ALUBLINDO  
N 45 PORTA  
N 53 PORTA
- ALU-MEC: SYNTHESIS 57 PORTA  
SYNTHESIS 60TT PORTA
- DOMAL: DOMAL SECURITY  
DOMAL STOPPER PG PORTA
- METRA: NC 45 INTERNATIONAL PORTA  
NC 55 INTERNATIONAL PORTA  
NC 68 SUPER THERMIC PORTA  
NUOVO NC 50 PORTA  
SUPERBLINDO
- SCHÜCO: ROYAL 78 ST BLINDATO
- PASSERINI: EKIP THERMO 53 PORTA

Black-painted  
aluminium  
22,5X10 mm

**038072** D 1 - 1

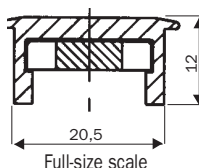

- ALCAN: HABITAT PORTA
- ALCOA: F40 PORTA  
F40 TT PORTA  
F50 PORTA  
F50 TT PORTA  
F60 TT PORTA
- ALUSUISSE: ALSEC 2000 PORTA 59  
ALSEC 2000 PORTA 69
- BODEGA: EXTRABLIND 70
- DOMAL: DOMAL BREAK 52 PORTA  
DOMAL BREAK 70 PORTA  
DOMAL SHOPS
- NEW-TEC: NEW-TEC 52 PORTA COMP.  
NEW-TEC 68 PORTA COMP.
- OCMA: SV 47 PORTA 1 ANTA  
SV 62 PORTA 1 ANTA  
SV 62 TT PORTA

Black-painted  
aluminium  
20,5X12 mm

**038073** D 1 - 1

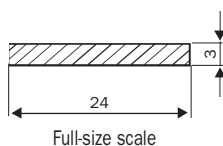

- ALCOA: FB12 GA / FB 12 TT  
SE GA / GR9
- ALL.CO: VZ 400 / VZ 500
- ALNOR: 400 / 500
- ALU-MEC: ELEGANT
- BODEGA: 40 / 50 / 900
- DOMAL: DOMAL BREAK 52 FINESTRA  
DOMAL BREAK 70 FINESTRA  
DOMAL STOPPER PG FIN.
- ESA: BLINDAL 60
- FINAL: EXPORT 50  
EXPORT 50 TT
- ITES: EXPORT 40
- METRA: NC 40 / NC 50 B  
NC 45 INTERNATIONAL FIN.  
NC 55 INTERNATIONAL FIN.  
NUOVO NC 50 PORTA  
SUPERBLINDO
- PASSERINI: EKIP 40 S / EKIP TT  
TGP 40 / TGP 50

Black-painted  
aluminium  
24X3 mm



**038074** C 1 - 1

Striking plate for multi-point locks, same length as front plate.

**FOR 1-WINGED DOORS WITHOUT TIPS,  
WITH 3 DEADBOLT SEATS.**

Black-painted. Screws. Instruction sheet.



Code

Min. ord.  
Multiple package  
Single package  
Status

**In steel for metal frames**



Full-size scale

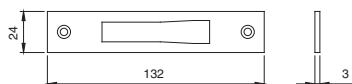

Striking plate for European-cylinder frames and double-bit rail frames In **STAINLESS STEEL 132x24x3**.

For locks with **DEADBOLT, HOOK AND DEVIATORS ONLY** for aluminium frames series 78\* - 96\*

**ALCOA** Fb 12 Blindato  
Fb 12 Trad./Revamping  
Gr 9  
Plana 1 Anta  
**ESA** Blindal 60 Porta 1 Anta  
Blindal 60 Porta 2 Anta  
ESA Blindal 70 Porta 1 Anta  
Blindal 70 Porta 2 Anta  
**SCHLICO** Royal S 50 N  
Royal S 55 Tl  
Royal S 65 Tl

**038020** A 10 - 10



Full-size scale

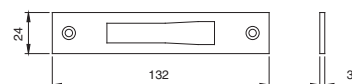

Striking plate for European-cylinder frames and double-bit rail frames In zinc-plated steel **132x24x3**.

For locks with **DEADBOLT, HOOK AND DEVIATORS ONLY** for aluminium frames series 78\* - 96\*

**Alcan** Abithal Cristal / Abithal Keeper Porta C.E.  
Winner Finestra  
**Alcoa** Fb 12 Ga / Europa Ga / Fb 12 T.T. / R 35 Reversible  
R 35 Sormonto  
**All.Co** Export 40 Finestra / Export 50 Finestra  
Export 50 Tl Finestra / Final 40 Finestra / Sicurlin C.E.  
**Alu-mec** Synthesis 45 Finestra / Synthesis 57 Finestra  
Synthesis 60 Tl Finestra  
**Alusuisse** Alsec 2000 Finestra 59 / Alsec 2000 Finestra 69  
**Bodega** Bga 50 / New Bt 60  
**Domal** Domal Break 52 Finestra / Domal Break 70 Finestra  
Domal Stopper Pg Finestra  
**Equipu** Sistema 8000 G.A. Finestra 1 Anta  
Sistema 8000 G.A. Finestra 2 Anta  
**Esa** Isola Porta  
**Esedra** Ga 53 Porta / Ga 53 Porta / Tl 63 Porta / Tl 63 Porta  
Tl 75 Porta / Tl 75 Porta  
**Indinvest** Gold 400 Complanare / Gold 400 Sormonto  
Gold 500 Complanare / Gold 500 Sormonto  
Gold 600 Complanare / Gold 600 Sormonto  
**Metra** Nc 45 International Finestra / Nc 45 Superthermic  
Finestra  
Nc 55 International Finestra / Nc 68 Superthermic Finestra  
**Morelli** Ma 8300  
**Ocma** Fc 47 Finestra / Fc 55 Finestra / Fc 60 Tl Finestra  
**Passerini** Ekip 40 Evoluzione 2 Ante / Ekip 40 Sormonto 2 Ante  
Ekip 50 Sormonto 2 Ante / Ekip Maastricht 53 Finestra  
Ekip Maastricht Th 60 Finestra / Ekip Maastricht Th 68 Finestra  
**Profilati** "Pe "Eku 53" Finestra / "Pe "Eku 64 Tl" Finestra  
"Pe "Eku 72 Tl" Finestra"

**038022** B 10 - 10



Full-size scale

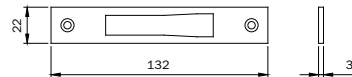

Striking plate for European-cylinder frames and double-bit rail frames In **STAINLESS STEEL 133x22x3**.

For locks with **DEADBOLT, HOOK AND DEVIATORS ONLY** for aluminium frames series 78\* - 96\*

**038021** B 10 - 10

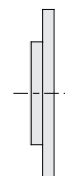

Full-size scale

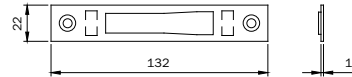

Striking plate for European-cylinder frames and double-bit rail frames. In **STAINLESS STEEL 132x22x1,5**.

For locks with **DEADBOLT, HOOK AND DEVIATORS ONLY** for aluminium frames series 78\* - 96\*

**Alcan** Abithal Cristal / Abithal Keeper Porta C.E.  
Winner Finestra  
**Alcoa** Fb 12 Ga / Europa Ga / Fb 12 T.T. / R 35 Reversible  
R 35 Sormonto  
**All.Co** Export 40 Finestra / Export 50 Finestra  
Export 50 Tl Finestra / Final 40 Finestra / Sicurlin C.E.  
**Alu-mec** Synthesis 45 Finestra / Synthesis 57 Finestra  
Synthesis 60 Tl Finestra  
**Alusuisse** Alsec 2000 Finestra 59 / Alsec 2000 Finestra 69  
**Bodega** Bga 50 / New Bt 60  
**Domal** Domal Break 52 Finestra / Domal Break 70 Finestra  
Domal Stopper Pg Finestra  
**Equipu** Sistema 8000 G.A. Finestra 1 Anta  
Sistema 8000 G.A. Finestra 2 Anta  
**Esa** Isola Porta  
**Esedra** Ga 53 Porta / Ga 53 Porta / Tl 63 Porta / Tl 63 Porta  
Tl 75 Porta / Tl 75 Porta  
**Indinvest** Gold 400 Complanare / Gold 400 Sormonto  
Gold 500 Complanare / Gold 500 Sormonto  
Gold 600 Complanare / Gold 600 Sormonto  
**Metra** Nc 45 International Finestra / Nc 45 Superthermic  
Finestra  
Nc 55 International Finestra / Nc 68 Superthermic Finestra  
**Morelli** Ma 8300  
**Ocma** Fc 47 Finestra / Fc 55 Finestra / Fc 60 Tl Finestra  
**Passerini** Ekip 40 Evoluzione 2 Ante / Ekip 40 Sormonto 2 Ante  
Ekip 50 Sormonto 2 Ante / Ekip Maastricht 53 Finestra  
Ekip Maastricht Th 60 Finestra / Ekip Maastricht Th 68 Finestra  
**Profilati** "Pe "Eku 53" Finestra / "Pe "Eku 64 Tl" Finestra  
"Pe "Eku 72 Tl" Finestra"

**038025** B 10 - 10



Code

Status  
Single package  
Multiple package  
Min. ord.

**In steel for metal frames**



Full-size scale

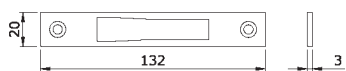

METRA PARETI MOBILI

Striking plate for frames and rail frames.  
In STAINLESS STEEL **132x20x3** for series 77\* - 78\* - 96\*  
**ONLY DEADBOLT, HOOK AND DEVIATORS**

**038027** D 1 10 10



Full-size scale

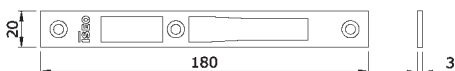

METRA PARETI MOBILI

Striking plate for frames and rail frames.  
In STAINLESS STEEL **180x20x3** for series 77\* - 78\*  
with **DEADBOLT, LATCHBOLT/ROLLER** and electric locks with handle  
**FOR SERIES 96\* WITH DEADBOLT AND LATCHBOLT**

**038028** D 1 10 10



Full-size scale

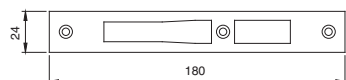

**ALCOA** Fb 12 Blindato  
Fb 12 Trad./Revamping  
Gr 9  
Plana 1 Anta  
**ESA** Blindal 60 Porta 1 Anta  
Blindal 60 Porta 2 Anta  
**ESA** Blindal 70 Porta 1 Anta  
Blindal 70 Porta 2 Anta  
**SCHICO** Royal S 50 N  
Royal S 55 Tt  
Royal S 65 Tt

Striking plate for European-cylinder frames and double-bit rail frames  
STAINLESS STEEL **180x24x3**. For aluminium frames series  
77\* - 78\* with **DEADBOLT, LATCHBOLT/ROLLER** and electric locks  
with handle **FOR SERIES 96\* WITH DEADBOLT AND LATCHBOLT**

**038030** A 10 - 10



Full-size scale

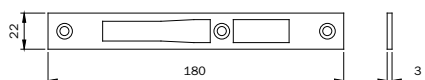

**Alcan** Abithal Cristal / Abithal Keeper Porta C.E.  
Winner Finestra  
**Alcoa** Fb 12 Ga / Europa Ga / Fb 12 T.T. / R 35 Reversibile  
R 35 Sormonto  
**All.Co** Export 40 Finestra / Export 50 Finestra  
Export 50 Tt Finestra / Final 40 Finestra / Scutblin C.E.  
**Alu-mec** Synthesis 45 Finestra / Synthesis 57 Finestra  
Synthesis 60 Tt Finestra  
**Alusuisse** Alsec 2000 Finestra 59 / Alsec 2000 Finestra 69  
**Bollega** Oga 50 / New Bt 60  
**Domal** Domal Break 52 Finestra / Domal Break 70 Finestra  
Domal Stopper Pg Finestra  
**Equipu** Sistema 8000 G.A. Finestra 1 Anta  
Sistema 8000 G.A. Finestra 2 Anta  
**Esa** Isola Porta  
**Esdra** Ga 53 Porta / Ga 53 Porta / Tt 63 Porta / Tt 63 Porta  
Tt 75 Porta / Tt 75 Porta  
**Indinvest** Gold 400 Complanare / Gold 400 Sormonto  
Gold 500 Complanare / Gold 500 Sormonto  
Gold 600 Complanare / Gold 600 Sormonto  
**Metra** No 45 International Finestra / No 45 Superthermic  
Finestra  
No 55 International Finestra / No 68 Superthermic Finestra  
**Morelli** Ma 8300  
**Ocma** Fc 47 Finestra / Fc 55 Finestra / Fc 60 Tt Finestra  
**Passerini** Ekip 40 Evoluzione 2 Anta / Ekip 40 Sormonto 2 Anta  
Ekip 50 Sormonto 2 Anta / Ekip Maastricht 53 Finestra  
Ekip Maastricht Th 60 Finestra / Ekip Maastricht Th 68 Finestra  
**Profilati** "Pe" "Eku 53" Finestra / "Pe" "Eku 64 Tt" Finestra  
"Pe" "Eku 72 Tt" Finestra"

Striking plate for European-cylinder frames and double-bit rail frames  
STAINLESS STEEL **180x22x3**. For aluminium frames series 77\*  
78\* with **DEADBOLT, LATCHBOLT/ROLLER** and electric locks with  
handle **FOR SERIES 96\* WITH DEADBOLT AND LATCHBOLT**

**038031** B 10 - 10



Full-size scale

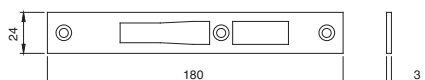

**ALCOA** Fb 12 Blindato  
Fb 12 Trad./Revamping  
Gr 9  
Plana 1 Anta  
**ESA** Blindal 60 Porta 1 Anta  
Blindal 60 Porta 2 Anta  
**ESA** blindal 70 Porta 1 Anta  
Blindal 70 Porta 2 Anta  
**SCHICO** royal S 50 N  
Royal S 55 Tt  
Royal S 65 Tt

Striking plate for European cylinder frames.  
In stainless steel **180x24x3**. For **LATCHBOLT AND HOOK LOCKS**  
for aluminium frames series 77\*-78\*

**038033** C 10 - 10



Code

Min. ord.  
Multiple  
package  
Single  
package  
Status

**In steel  
for metal frames**

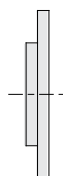

Full-size scale

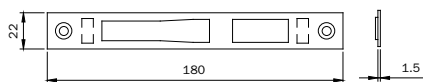

**ADJUSTABLE** striking plate for European cylinder frames and double-bot rail frames. **STAINLESS STEEL 180x22x1,5**. For aluminium frame series 77\*-78\* For locks with **DEADBOLT AND LATCHBOLT/ROLLER** and electric lock with handle. **FOR SERIES 96\* WITH DEADBOLT AND LATCHBOLT.**

**038035** B 10 - 10

- Alcan Abithal Cristal / Abithal Keeper Porta C.E.
- Winner Finestra
- Alcoa Fb 12 Ga / Europa Ga / Fb 12 T.T. / R 35 Reversible R 35 Sormonto
- All.Co Export 40 Finestra / Export 50 Finestra
- Export 50 Tl Finestra / Final 40 Finestra / Scurlin C.E.
- Alu-mec Synthesis 45 Finestra / Synthesis 57 Finestra Synthesis 60 Tl Finestra
- Alusuisse Alsec 2000 Finestra 59 / Alsec 2000 Finestra 69
- Bodega Bga 50 / New Bt 60
- Domal Domal Break 52 Finestra / Domal Break 70 Finestra Domal Stopper Pg Finestra
- Equipu Sistema 8000 G.A. Finestra 1 Anta Sistema 8000 G.A. Finestra 2 Anta
- Esa Isola Porta
- Esedra Ga 53 Porta / Ga 53 Porta / Tl 63 Porta / Tl 63 Porta Tl 75 Porta / Tl 75 Porta
- Indinvest Gold 400 Complanare / Gold 400 Sormonto Gold 500 Complanare / Gold 500 Sormonto Gold 600 Complanare / Gold 600 Sormonto
- Metra Nc 45 International Finestra / Nc 45 Superthermic Finestra Nc 55 International Finestra / Nc 68 Superthermic Finestra
- Morelli Ma 8300
- Ocma Fc 47 Finestra / Fc 55 Finestra / Fc 60 Tl Finestra
- Passerini Ekip 40 Evoluzione 2 Ante / Ekip 40 Sormonto 2 Ante Ekip 50 Sormonto 2 Ante / Ekip Maastricht 53 Finestra Ekip Maastricht Th 60 Finestra / Ekip Maastricht Th 68 Finestra
- Profilati \*Pe \*\*Eku 53\*\* Finestra / \*Pe \*\*Eku 64 Tl\*\* Finestra \*Pe \*\*Eku 72 Tl\*\* Finestra



Full-size scale



**ADJUSTABLE** striking plate for European cylinder frames and double-bit rail frames **STAINLESS STEEL 180x22x3**. For aluminium frames series 77\*- 78\* with **DEADBOLT, LATCHBOLT/ROLLER** and electric locks with handle **FOR SERIES 96\* WITH DEADBOLT AND LATCHBOLT**

**038106** B 10 - 10

- Alcan Abithal Cristal / Abithal Keeper Porta C.E.
- Winner Finestra
- Alcoa Fb 12 Ga / Europa Ga / Fb 12 T.T. / R 35 Reversible R 35 Sormonto
- All.Co Export 40 Finestra / Export 50 Finestra
- Export 50 Tl Finestra / Final 40 Finestra / Scurlin C.E.
- Alu-mec Synthesis 45 Finestra / Synthesis 57 Finestra Synthesis 60 Tl Finestra
- Alusuisse Alsec 2000 Finestra 59 / Alsec 2000 Finestra 69
- Bodega Bga 50 / New Bt 60
- Domal Domal Break 52 Finestra / Domal Break 70 Finestra Domal Stopper Pg Finestra
- Equipu Sistema 8000 G.A. Finestra 1 Anta Sistema 8000 G.A. Finestra 2 Anta
- Esa Isola Porta
- Esedra Ga 53 Porta / Ga 53 Porta / Tl 63 Porta / Tl 63 Porta Tl 75 Porta / Tl 75 Porta
- Indinvest Gold 400 Complanare / Gold 400 Sormonto Gold 500 Complanare / Gold 500 Sormonto Gold 600 Complanare / Gold 600 Sormonto
- Metra Nc 45 International Finestra / Nc 45 Superthermic Finestra Nc 55 International Finestra / Nc 68 Superthermic Finestra
- Morelli Ma 8300
- Ocma Fc 47 Finestra / Fc 55 Finestra / Fc 60 Tl Finestra
- Passerini Ekip 40 Evoluzione 2 Ante / Ekip 40 Sormonto 2 Ante Ekip 50 Sormonto 2 Ante / Ekip Maastricht 53 Finestra Ekip Maastricht Th 60 Finestra / Ekip Maastricht Th 68 Finestra
- Profilati \*Pe \*\*Eku 53\*\* Finestra / \*Pe \*\*Eku 64 Tl\*\* Finestra \*Pe \*\*Eku 72 Tl\*\* Finestra

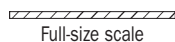

Full-size scale

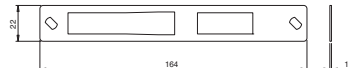

**ADJUSTABLE** striking plate for European cylinder frames. **STAINLESS STEEL 164x22x1**. For locks with **DEADBOLT AND LATCHBOLT** for aluminium frames series 78\* - 79\*

**038032** C 10 - 10

**ADJUSTABLE** striking plate for European cylinder frames and double-bot rail frames. **STAINLESS STEEL 134x22x1**. For locks with **DEADBOLT AND DEVIATORS ONLY** for aluminium frames series 79\* - 96\* - 98\*

**038034** D 10 - 10

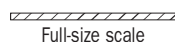

Full-size scale

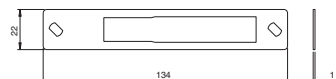



Code

Status  
Single package  
Multiple package  
Min. ord.

**In steel for metal frames**

Full-size scale

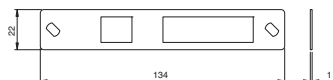

**ADJUSTABLE** closed striking plate **FOR HOOK DEVIATORS**  
STAINLESS STEEL **134x22x1**. for aluminium frames 79\*-

**038036** D 10 - 10



Full-size scale

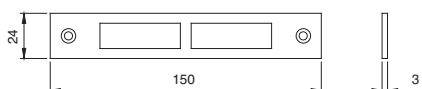

Striking plate for mechanical double-bit rail frames.  
STAINLESS STEEL **150x24x3**. For **DEADBOLT AND LATCHBOLTLOCKS** for aluminium frames series 981\* - 983\*

ALCOA: FB 12 GA / FB 12 TT  
SE GA / GR9  
ALLCO: VZ 400 / 500  
ALNOR: 400 / 500  
ALU-MEC: Elegant  
BODEGA: BO 40 / 50 / 900  
ESA: Blindal 60 / 70  
NT 40 G / 50 G  
DOMAL: Domal Stopper PG fin.  
Domal Break 52 / 70 finestra  
Domal 40 sormonto 1 anta  
METRA: NC 40 / NC 50 B  
NC 45 / 55 international finestra  
PASSERINI: TGP 40 / TGP 50  
Ekip 40 / 50 sormonto 2 ante  
PANDOLFO SCHUCO:  
Royal S 50 / Royal S 55 TT  
Royal S 65 T

**038050** D 10 - 10

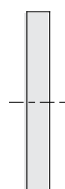

Full-size scale

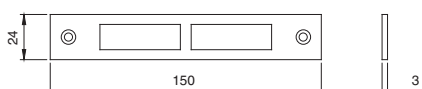

Striking plate for double-bit rail frames with **DEADBOLT AND LATCHBOLT**. **150x24x3**. Zinc-plated steel. For locks series 981 - 983

**038080** A 10 - 10



Full-size scale

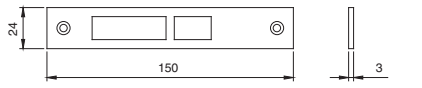

Striking plate for double-bit rail frames electric locks.  
STAINLESS STEEL **150x24x3**. For **ELECTRIC LOCKS** for aluminium frames series 981\* - 983\*

ALCOA: FB 12 GA / FB 12 TT  
SE GA / GR9  
ALLCO: VZ 400 / 500  
ALNOR: 400 / 500  
ALU-MEC: Elegant  
BODEGA: BO 40 / 50 / 900  
ESA: Blindal 60 / 70  
NT 40 G / 50 G  
DOMAL: Domal Stopper PG fin.  
Domal Break 52 / 70 finestra  
Domal 40 sormonto 1 anta  
METRA: NC 40 / NC 50 B  
NC 45 / 55 international finestra  
PASSERINI: TGP 40 / TGP 50  
Ekip 40 / 50 sormonto 2 ante  
PANDOLFO SCHUCO:  
Royal S 50 / Royal S 55 TT  
Royal S 65 T

**038060** D 10 - 10

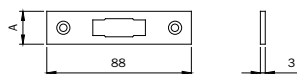

Striking plate for oval-cylinder frames.  
For LOCKS with **LATCHBOLT OR ROLLER ONLY** 762 - 764

CHROME-PLATED steel 88x16x3

**033003** B 10 - 10

CHROME-PLATED steel 88x20x3.

**033004** B 10 - 10

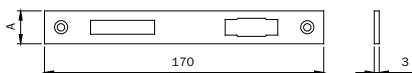

Striking plate for oval-cylinder frames.  
For locks with **LATCHBOLT AND DEADBOLT OR ROLLER** only 750 - 751 - 752 - 753

CHROME-PLATED steel 170x16x3.

**033013** C 10 - 10

CHROME-PLATED steel 170x20x3.

**033014** B 10 - 10

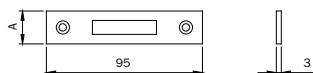

Striking plate for oval-cylinder frames.  
For LOCKS with **DEADBOLT ONLY** series 758 - 759 - 760 - 761

CHROME-PLATED steel 95x16x3

**033033** D 10 - 10

CHROME-PLATED steel 95x20x3.

**033034** B 10 - 10



Code

Status  
Single  
package

Min. ord.

**In steel  
for metal frames**

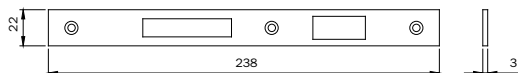

Striking plate for European cylinder frames.

For locks with **DEADBOLT AND LATCHBOLT** series 741 - 743 - 745

STAINLESS STEEL <b>238x22x3</b>	<b>033080</b>	B	10	-	10
CHROME-PLATED steel <b>238x22x3</b>	<b>033083</b>	B	10	-	10
GOLD-PAINTED steel <b>238x22x3</b>	<b>033086</b>	D	10	-	10

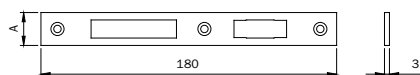

Striking plate for oval-cylinder frames. In chrome-plated steel 180x16x3.

For locks with **LATCHBOLT AND DEADBOLT OR ROLLER** only 754 - 755 - 756 - 757

CHROME-plated steel <b>180x16x3</b>	<b>033091</b>	D	10	-	10
<b>CORROSION-RESISTANT</b> CHROME-plated brass <b>180x16x3</b>	<b>033091.9</b>	D	10	-	10
CHROME-plated steel <b>180x20x3</b>	<b>033092</b>	D	10	-	10
<b>CORROSION-RESISTANT</b> chrome-plated brass <b>180x20x3</b>	<b>033092.9</b>	D	10	-	10

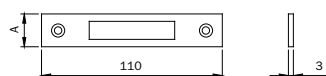

Striking plate for oval-cylinder frames.

For locks with **DEADBOLT ONLY** series 766 - 767

CHROME-plated steel <b>110x16x3</b>	<b>033093</b>	D	10	-	10
<b>CORROSION-RESISTANT</b> CHROME-plated brass <b>110x16x3</b>	<b>033093.9</b>	D	10	-	10
CHROME-plated steel <b>110x20x3</b>	<b>033094</b>	D	10	-	10
<b>CORROSION-RESISTANT</b> chrome-plated brass <b>110x20x3</b>	<b>033094.9</b>	D	10	-	10

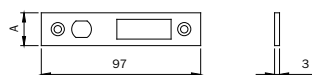

Striking plate for oval-cylinder frames.

For **HOOK** locks series 768 - 769

CHROME-plated steel <b>97x20x3</b>	<b>033095</b>	D	10	-	10
<b>CORROSION-RESISTANT</b> chrome-plated brass <b>97x16x3</b>	<b>033095.9</b>	D	10	-	10



Code

Min. ord.  
Multiple  
package  
Single  
package  
Status

**In aluminium  
for metal frames**



Full-size scale

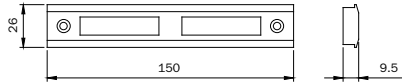

**ALCOA:**  
R 50 / R 50TT  
**ALL.CO:**  
All.co 5 TT porta  
Sicurlin 65  
Export 50 TT porta  
**DOMAL:**  
Domal Break 52 / 70 porta  
**INDINVEST:**  
Alpha 445 porta  
**METRA:**  
NC 40 sormonto 2 ante  
NC 45 / 55 /68 superthermic porta

Striking plates for oval cylinder frames.  
In black anodised ALUMINIUM. For **LOCKS**  
series 750 - 751 - 752 - 753. **UNTIL EXHAUSTION**

**033152** D 10 - 10

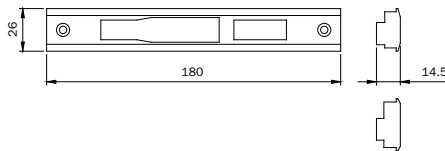
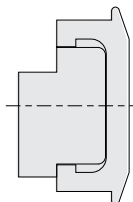

**ALU-K:** N45 reversibile  
**METRA:** Nuovo NC 50 porta  
**PASSERINI:**  
Ekip Thermo 53 fin. 1 anta

Striking plate for European cylinder frames and double-bit rail frames  
In black anodised ALUMINIUM. For **LOCKS**  
**WITH DEADBOLT AND ROLLER** series 78\* - 96\* - 98\*  
**UNTIL EXHAUSTION**

**038111** D 10 - 10

Full-size scale

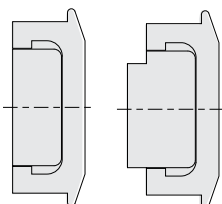

Full-size scale

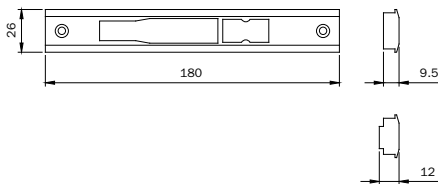

**ALCAN:** Winner porta  
**ALCOA:** R50/R50TT sorm. 1/2 a.  
**ALL.CO:** All.co 5 porta  
All.co 5 TT porta / Sicurlin 65  
**ALNOR:** Montreal porta  
**ALU-K:**  
N45 / N63 / N55 TT / 62 TT porta  
N53 / N56 TT complanare  
Alublindo  
**ALU-MEC:**  
Synthesis 57 / 60 TT porta  
**ALUSUISSE:**  
Aisec 2000 porta 59  
**DOMAL:**  
Domal stopper PG porta  
Domal break 52 porta  
Domal Security porta  
**ESA:** Giuntall porta  
**FINAL:** Export 50/50 TT porta  
**INDINVEST:**  
Alpha 445 porta 2 ante  
**METRA:** Nuovo NC 50 porta  
Nuovo NC 40 sormonto 2 ante  
Nuovo NC 40/NC 50 complanare  
NC 45 / 55 international porta  
NC 45 / 68 superthermic porta  
Superblindo  
**NEW-TEC:** 50/52/60 porta comp.  
50 / 52 TT / 68 TT porta sormonto  
**PANDOLFO SCHUCO:**  
Royal 78 ST Blindato  
**PASSERINI:**  
Ekip Thermo 53 finestra 2 ante  
Ekip Thermo 53 porta  
**Profital:** Sistema 1 sorm. 2 ante  
Sistema 1 compl. 2 ante

solo per 981-983  
**ALCOA:**  
R50 reversibile 1/2 ante  
**ALL.CO:** All.co 5  
**ALU-K:** N45 complanare

European cylinder striking plate for electric locks for frames  
and double-bit rail frames. In black-anodized ALUMINIUM  
For **ELECTRIC LOCKS**  
series 791 - 793 - 981 - 983.  
**UNTIL EXHAUSTION**

**038122** D 10 - 10



Code

Min. ord.  
Multiple  
package  
Single  
package  
Status

**In nylon  
for metal frames**



Full-size scale

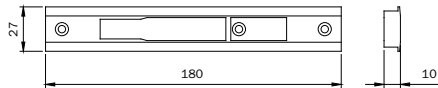

- All.Co** All.Co 5 Porta  
All.Co 5 Tl Porta  
Export 50 Porta  
Export 50 Tl Porta  
Scurlbin 65
- Alcan** Abithal Porta  
Winner Porta
- Alnor** Montreal Porta
- Aluk** Alublindo  
N 45 Porta  
N 53 Porta  
N 55 Tl Porta  
N 62 Tl Porta
- Alumec** Synthesis 60Tl Porta
- Alusisse** Asec 2000 Porta 59  
Asec 2000 Porta 59  
Asec 2000 Porta 69
- Bodega** Extrablind 70
- Domal** Domal Break 52 Porta  
Domal Security Porta  
Domal Shops Porta  
Domal Stopper Pg Porta
- Metra** No. 45 International Porta  
No. 45 Superthermic Porta  
No. 55 International Porta  
No. 68 Superthermic Porta  
Nuovo No. 50 Porta  
Superblindo
- Ocma** Sv 47 Porta 1 Anta  
Sv 47 Porta 2 Ante  
Sv 62 Porta 1 Anta  
Sv 62 Porta 2 Ante  
Sv 62 Tl Porta 1 Anta  
Sv 62 Tl Porta 2 Ante
- Passehill** Ekip Maastricht 53 Porta 1 Anta  
Ekip Maastricht 53 Porta 2 Ante  
Ekip Maastricht Th 60 Porta 1 Anta  
Ekip Maastricht Th 60 Porta 2 Ante  
Ekip Maastricht Th 68 Porta 1 Anta  
Ekip Maastricht Th 68 Porta 2 Ante  
Ekip Thermo 53 Porta
- Schuco** Royal 78 St. Blindato
- Wicona** L60-A  
L70-A

European cylinder striking plate for frames. In NYLON.  
For **LOCKS WITH DEADBOLT, LATCHBOLT, ROLLER  
AND ELECTRIC LOCKS** for aluminium frames  
series 78\*-79\*

**038011** B 10 - 10

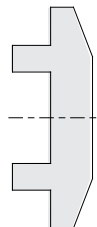

Full-size scale

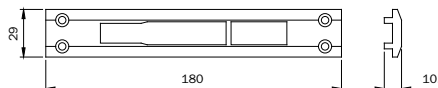

- Alcoa** Alublind  
R 40 Reversibile 1 Anta  
R 40 Reversibile 2 Ante  
R 40 Sormonto 1 Anta  
R 40 Sormonto 2 Ante  
R 50 Sormonto 1 Anta  
R 50 Sormonto 2 Ante  
R 50 Tl Sormonto 1 Anta  
R 50 Tl Sormonto 2 Ante  
R 60 Tl Complanare
- Alumec**Synthesis 57 Porta  
New TecNew Tec 50 Porta Sormonto  
New Tec 52 Tl Porta Sormonto  
New Tec 60 Tl Porta Sormonto  
New Tec 68 Tl Porta Sormonto

European cylinder striking plate for frames. In NYLON.  
For **LOCKS WITH DEADBOLT, LATCHBOLT, ROLLER  
AND ELECTRIC LOCKS** for aluminium frames  
series 78\*-79\*

**038012** B 10 - 10

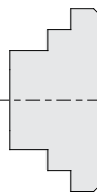

Full-size scale

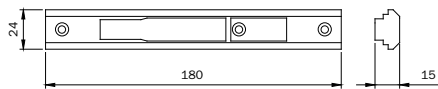

- Alcoa** Plana 2 Ante  
IndimetaAlpha 255 Complanare  
Alpha 370 Tl Complanare  
Alpha Blitz 2000  
Alpha Globo 65

European cylinder striking plate for frames. In NYLON.  
For **LOCKS WITH DEADBOLT, LATCHBOLT, ROLLER  
AND ELECTRIC LOCKS** for aluminium frames series 78\*-79\*

**038013** D 10 - 10



Full-size scale

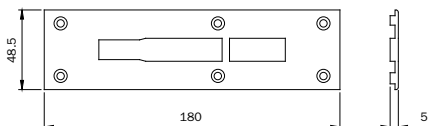

- Alcoa** Fb 12 Trad./Revamping

European cylinder striking plate for frames. In NYLON.  
For **LOCKS WITH DEADBOLT, LATCHBOLT, ROLLER  
AND ELECTRIC LOCKS** for aluminium frames series 78\*-79\*

**038014** B 10 - 10





Code

Min. ord.  
Multiple  
package  
Single  
package  
Status

**In nylon  
for metal frames**

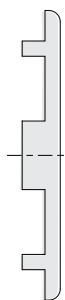

Full-size scale

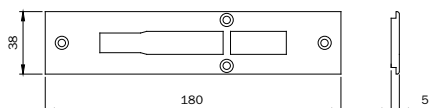

Alcoa Fb 12 Blindato  
Gr 9  
Plana 1 Anta  
Esa Blindal 60 Porta 1 Anta  
Blindal 60 Porta 2 Ante

European cylinder striking plate for frames. In NYLON.

For **LOCKS WITH DEADBOLT, LATCHBOLT, ROLLER AND ELECTRIC LOCKS**

for aluminium frames series 78\*-79\*.

**038015** B 10 - 10

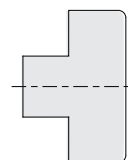

Full-size scale

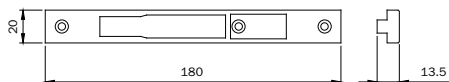

Indinvest Alpha 658 Tt Complanare

European cylinder striking plate for frames. In NYLON.

For **LOCKS WITH DEADBOLT, LATCHBOLT, ROLLER AND ELECTRIC LOCKS**

for aluminium frames series 78\*-79\*.

**038016** D 10 - 10

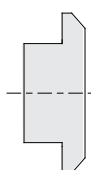

Full-size scale

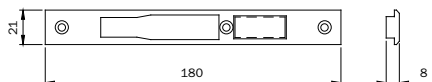

Alcan Abithal Cristal / Abithal Keeper Porta C.E  
Winner Finestra  
Alcoa Fb 12 Ga / Europa Ga / Fb 12 T.T. / R 35 Reversibile  
R 35 Sormonto  
All.Co Export 40 Finestra / Export 50 Finestra  
Export 50 Tt Finestra / Final 40 Finestra  
Alu-mec Synthesis 45 Finestra / Synthesis 57 Finestra  
Synthesis 60 Tt Finestra  
Alusuisse Aisec 2000 Finestra 59 / Aisec 2000 Finestra 69  
Bottega Bga 50 / New Bt 60  
Domal Domal Break 52 Finestra / Domal Break 70 Finestra  
Domal Stopper Pg Finestra  
EquipeSistema 8000 G.A. Finestra 1 Anta  
Sistema 8000 G.A. Finestra 2 Ante  
Esa Isola Porta  
Esedra Ga 53 Porta / Tt 63 Porta / Tt 75 Porta  
Indinvest Gold 400 Complanare / Gold 400 Sormonto  
Gold 500 Complanare / Gold 500 Sormonto  
Gold 600 Complanare / Gold 600 Sormonto  
Metra Nc 45 International Finestra  
Nc 45 Superthermic Finestra / Nc 55 International Finestra  
Nc 68 Superthermic Finestra  
Morelli Ma 8300  
Ocma Fc 47 Finestra / Fc 55 Finestra / Fc 60 Tt Finestra  
Passerini Ekip 40 Evoluzione 2 Ante  
Ekip 40 Sormonto 2 Ante / Ekip 50 Sormonto 2 Ante  
Ekip Maastricht 53 Finestra / Ekip Maastricht Th 60 Finestra  
Ekip Maastricht Th 68 Finestra  
Profilati "Pe""Eku 53"" Finestra" / "Pe""Eku 64 Tt""  
Finestra"  
"Pe""Eku 72 Tt"" Finestra"

European cylinder striking plate for frames. In NYLON.

For **LOCKS WITH DEADBOLT, LATCHBOLT, ROLLER**

**AND ELECTRIC LOCKS** with handle for aluminium frames series 78\*.

**038319** B 10 - 10

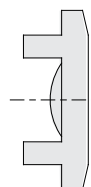

Full-size scale

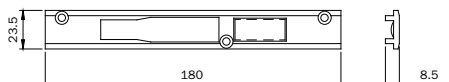

All.Co Ites P4 Sormonto  
Metra Nuovo Nc 40 Sormonto 1 Anta  
Passerini Ekip 40 Evoluzione 1 Anta  
Ekip 40 Sormonto 1 Anta  
Profilati Sistema Pe 1 40 Comp./Est. 1 Anta  
Sistema Pe 1 40 Sormonto 1 Anta  
Sistema Pe 1 50 Comp./Est. 1 Anta  
Sistema Pe 1 50 Sormonto 1 Anta

European cylinder striking plate for frames. In NYLON. For **LOCKS**

**WITH DEADBOLT, LATCHBOLT, ROLLER AND ELECTRIC**

**LOCKS** with handle for aluminium frames series 78\*.

**038320** D 10 - 10



Code

Min. ord.  
Multiple  
package  
Single  
package  
Status

**In nylon  
for metal frames**

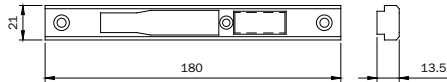
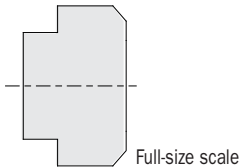

Alcoa Formula F40 Porta  
Formula F40 Tl Porta  
Formula F50 Porta  
Formula F50 Tl Porta  
Formula F60 Tl Porta  
**All.Co All.Co 5** Complanare  
Ites P4 Complanare  
**Alnor** Blindo Block  
Montreal G.A.  
**Alu-k** N 53 Complanare  
N 55 Tl Complanare  
**Bodega** Extrablind 70  
**Domal Domal** Break 70 Porta  
**Esa** Giuntall Porta  
**Indinvest** Alpha 445 Finestra  
Alpha 445 Porta 1 Ante  
Alpha Globo 45  
**Metra** Nuovo Nc 40 Complanare  
Nuovo Nc 40 Sormonto 2 Ante  
Nuovo Nc 50 Complanare  
New TecMetra 50 Porta Complanare  
Metra 52 Tl Porta Complanare  
Metra 68 Tl Porta Complanare  
**Ocma** Fc 60 Tl Porta  
**Passerini** Ekip 40 Complanare 1 Ante  
Ekip 40 Complanare 2 Ante  
Ekip Thermo 53 Finestra 2 Ante  
**Profilati** "Pe "Eku 53" Porta"  
"Pe "Eku 64 Tl" Porta"  
"Pe "Eku 72 Tl" Porta"  
Sistema Pe 1 40 Comp./Est. 2 Ante  
Sistema Pe 1 40 Sormonto 2 Ante  
Sistema Pe 1 50 Comp./Est. 2 Ante  
Sistema Pe 1 50 Sormonto 2 Ante

European cylinder striking plate for frames. In NYLON.  
For **LOCKS WITH DEADBOLT, LATCHBOLT, ROLLER AND  
ELECTRIC LOCKS** with handle for aluminium frames  
series 78\*-79\*.

**038321** D 10 - 10

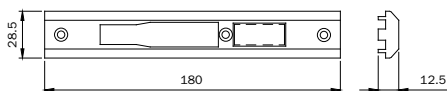
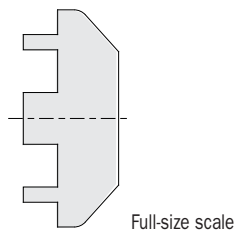

**All.Co All.Co 5** Reversibile  
**All.Co 5** Sormonto  
**Esa** Giuntall Complanare

European cylinder striking plate for frames. In NYLON. For **LOCKS  
WITH DEADBOLT, LATCHBOLT, ROLLER AND ELECTRIC LOCKS**  
with handle for aluminium frames series 78\*.

**038322** D 10 - 10

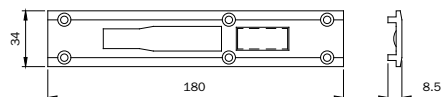
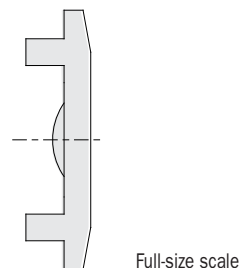

**Indinvest** Alpha 445 Porta 2 Ante  
**Metra** Nuovo Nc 50 Sormonto 1 Ante  
Nuovo Nc 50 Sormonto 2 Ante  
**Passerini** Ekip 50 Sormonto 1 Ante

European cylinder striking plate for frames. In NYLON. For **LOCKS  
WITH DEADBOLT, LATCHBOLT, ROLLER AND ELECTRIC LOCKS**  
with handle for aluminium frames series 78\*.

**038323** D 10 - 10

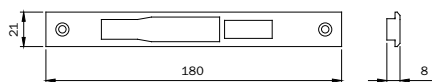
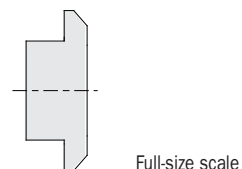

**ALCAN:** Winner finestra  
**ALCOA:** FB 12 TT / SE G.A.  
**Alu-mec:**Synthesis 45/57/60 TT  
**ALUSUISSE:**  
Alsec 2000 finestra 59 / 69  
**BODEGA:** BGA 50 /New BT60  
**DOMAL:** Domal Stopper PG fin.  
Break 52 finestra  
Break 70 finestra  
**EQUIPE** Sistema 8000  
Emai 40 W  
**ESA:** Isola porta  
**ESEDRA:**  
GA 53/TT63/TT 75 porta  
**FINAL:** Export 50/50 TT fin.  
**INDINVEST:** Gold 400/500/600  
**ITES:** Export 40 finestra  
**MORELLI** MA 8300  
**OCMA** FC 55 finestra  
**PASSERINI:** Ekip 40 S. 2 ante  
Ekip 40 evoluzione 2 ante  
Ekip 50 sormonto 2 ante  
Ekip thermo sormonto

European cylinder striking plate for frames. In NYLON.  
For **ELECTRIC LOCKS WITHOUT HANDLE**  
for aluminium frames  
series 78\*-79\*- **UNTIL EXHAUSTION**

**038419** D 10 - 10



Code

Min. ord.  
Multiple  
package  
Single  
package  
Status

**In nylon  
for metal frames**



Full-size scale

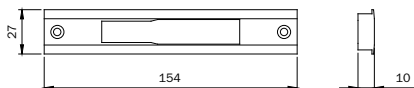

- All.Co Al.Co 5 Porta
- All.Co 5 Tl Porta
- Export 50 Porta
- Export 50 Tl Porta
- Sicurblin 65
- Alcan Alpthal Porta
- Winner Porta
- Alnor Montreal Porta
- Alu-k Alublindo
- N 45 Porta
- N 53 Porta
- N 53 Tl Porta
- N 62 Tl Porta
- Alu-mec Synthesis 60Tl Porta
- Alusuisse Alsec 2000 Porta 59
- Alsec 2000 Porta 59
- Alsec 2000 Porta 69
- Bodega Extrablind 70
- Domal Domal Break 52 Porta
- Domal Security Porta
- Domal Shops Porta
- Domal Stopper Pg Porta
- Metra Nc 45 International Porta
- Nc 45 Superthermic Porta
- Nc 55 International Porta
- Nc 68 Superthermic Porta
- Nuovo Nc 50 Porta
- Superblindo
- Ocma Sv 47 Porta 1 Anta
- Sv 47 Porta 2 Anta
- Sv 62 Porta 1 Anta
- Sv 62 Porta 2 Anta
- Sv 62 Tl Porta 1 Anta
- Sv 62 Tl Porta 2 Anta
- Passerini Ekip Maastricht 53 Porta 1 Anta
- Ekip Maastricht 53 Porta 2 Anta
- Ekip Maastricht Th 60 Porta 1 Anta
- Ekip Maastricht Th 60 Porta 2 Anta
- Ekip Maastricht Th 68 Porta 1 Anta
- Ekip Maastricht Th 68 Porta 2 Anta
- Ekip Thermo 53 Porta
- Schiuco Royal 78 St. Blindato
- Wicono L60A
- L70A

European cylinder striking plate for frames. In NYLON.  
For LOCKS with **DEADBOLT AND DEVIATORS ONLY**  
for aluminium frames series 77\* - 78\*.

**038511** D 10 - 10



Code

Status  
Single package

Min. ord.

**In nylon for metal frames**

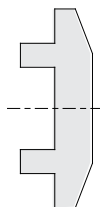

Full-size scale

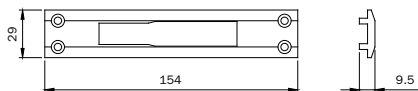

**Alcoa** Atubind  
R 40 Reversibile 1 Anta  
R 40 Reversibile 2 Ante  
R 40 Sormonto 1 Anta  
R 40 Sormonto 2 Anta  
R 50 Sormonto 1 Anta  
R 50 Sormonto 2 Anta  
R 50 Tl Sormonto 1 Anta  
R 50 Tl Sormonto 2 Anta  
R 60 Tl Complanare  
**Alu-mec**Synthesis 57 Porta  
New TecNew Tec 50 Porta Sormonto  
New Tec 52 Tl Porta Sormonto  
New Tec 60 Tl Porta Sormonto  
New Tec 68 Tl Porta Sormonto

European cylinder striking plate for frames. In NYLON.  
For locks with **DEADBOLT AND DEVIATORS ONLY**  
for aluminium frames series 77\* - 78\*.

**038512** D 10 - 10

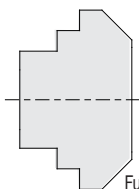

Full-size scale

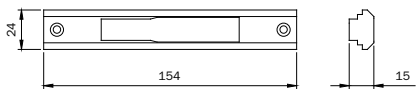

**Alcoa** Plana 2 Ante  
IndinvestAlpha 255 Complanare  
Alpha 370 Tl Complanare  
Alpha Blitz 2000  
Alpha Globo 55

European cylinder striking plate for frames. In NYLON.  
For locks with **DEADBOLT AND DEVIATORS ONLY**  
for aluminium frames series 77\* - 78\*.

**038513** D 10 - 10

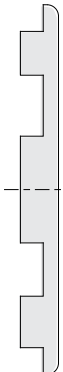

Full-size scale

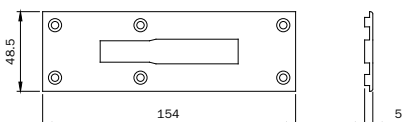

**Alcoa** Fb 12 Trad./Revamping

European cylinder striking plate for frames. In NYLON.  
For locks with **DEADBOLT AND DEVIATORS ONLY**  
for aluminium frames series 77\* - 78\*.

**038514** D 10 - 10

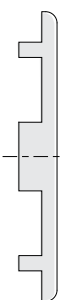

Full-size scale



**Alcoa** Fb 12 Blindato  
Gr 9  
Plana 1 Anta  
**Esa** Blindal 60 Porta 1 Anta  
Blindal 60 Porta 2 Anta

European cylinder striking plate for frames. In NYLON.  
For locks with **DEADBOLT AND DEVIATORS ONLY**  
for aluminium frames series 77\* - 78\*.

**038515** D 10 - 10



Code

Min. ord.  
Multiple package  
Single package  
Status

**In nylon for metal frames**

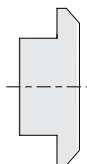

Full-size scale

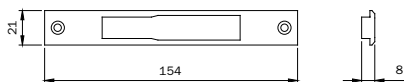

- Alcan Abithal Cristal / Abithal Keeper Porta C.E. Winner Finestra
- Alcoa Fb 12 Ga / Europa Ga / Fb 12 T.T. R 35 Reversible / R 35 Sormonto
- AlCo Export 40 Finestra / Export 50 Finestra Export 50 Tt Finestra / Final 40 Finestra
- Alu-mec Synthesis 45 Finestra Synthesis 57 Finestra / Synthesis 60 Tt Finestra
- Alusuisse Alsec 2000 Finestra 59 Alsec 2000 Finestra 69
- Bodega Bga 50 / New Bl 60
- Domal Domal Break 52 Finestra Domal Break 70 Finestra Domal Stopper Pg Finestra
- Equipe Sistema 8000 G.A. Finestra 1 Anta Sistema 8000 G.A. Finestra 2 Ante
- Esa Isola Porta
- Esedra Ga 53 Porta / Tt 63 Porta / Tt 75 Porta
- Indinvest Gold 400 Complanare Gold 400 Sormonto / Gold 500 Complanare Gold 500 Sormonto / Gold 600 Complanare Gold 600 Sormonto
- Metra Nc 45 International Finestra Nc 45 Superthermic Finestra Nc 55 International Finestra Nc 68 Superthermic Finestra
- Morelli Ma 8300
- Ocma Fc 47 Finestra / Fc 55 Finestra Fc 60 Tt Finestra
- Passenini Ekip 40 Evoluzione 2 Ante Ekip 40 Sormonto 2 Ante Ekip 50 Sormonto 2 Ante Ekip Maastricht 53 Finestra Ekip Maastricht Tt 60 Finestra Ekip Maastricht Tt 68 Finestra
- Profitali \*Pe\*Eku 53 Finestra \*Pe\* Eku 64 Tt Finestra \*Pe\* Eku 72 Tt Finestra

European cylinder striking plate for frames. In NYLON.  
For locks with **DEADBOLT AND DEVIATORS ONLY**  
for aluminium frames series 77\* - 78\*.

**038519** D 10 - 10

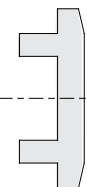

Full-size scale

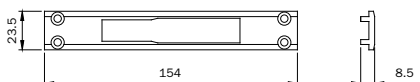

- AlCo Ites P4 Sormonto
- Metra Nuovo Nc 40 Sormonto 1 Anta
- Passenini Ekip 40 Evoluzione 1 Anta Ekip 40 Sormonto 1 Anta
- Profitali Sistema Pe 1 40 Comp./Est. 1 Anta Sistema Pe 1 40 Sormonto 1 Anta Sistema Pe 1 50 Comp./Est. 1 Anta Sistema Pe 1 50 Sormonto 1 Anta

European cylinder striking plate for frames. In NYLON.  
For locks with **DEADBOLT AND DEVIATORS ONLY**  
for aluminium frames series 77\* - 78\*.

**038520** D 10 - 10



Full-size scale

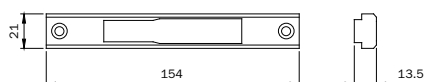

- Alcoa Formula F40 Porta Formula F40 Tt Porta Formula F50 Porta Formula F50 Tt Porta Formula F60 Tt Porta
- AlCo All.Co 5 Complanare Ites P4 Complanare
- Alnor Blindo Block Montreal G.A.
- Alu-k N 53 Complanare N 55 Tt Complanare
- Bodega Extrablind 70
- Domal Domal Break 70 Porta
- Esa Giuntali Porta
- Indinvest Alpha 445 Finestra Alpha 445 Porta 1 Anta Alpha Globo 45
- Metra Nuovo Nc 40 Complanare Nuovo Nc 40 Sormonto 2 Ante Nuovo Nc 50 Complanare New TecMetra 50 Porta Complanare Metra 52 Tt Porta Complanare Metra 68 Tt Porta Complanare
- Ocma Fc 60 Tt Porta
- Passenini Ekip 40 Complanare 1 Anta Ekip 40 Complanare 2 Ante Ekip Thermo 53 Finestra 2 Ante
- Profitali \*Pe\* "Eku 53" Porta \*Pe\* "Eku 64 Tt" Porta \*Pe\* "Eku 72 Tt" Porta Sistema Pe 1 40 Comp./Est. 2 Ante Sistema Pe 1 40 Sormonto 2 Ante Sistema Pe 1 50 Comp./Est. 2 Ante Sistema Pe 1 50 Sormonto 2 Ante

European cylinder striking plate for frames. In NYLON.  
For locks with **DEADBOLT AND DEVIATORS ONLY**  
for aluminium frames series 77\* - 78\*.

**038521** D 10 - 10



Code

Min. ord.  
Multiple  
package  
Single  
package  
Status

**In nylon  
for metal frames**

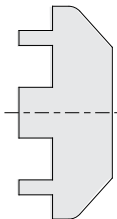

Full-size scale

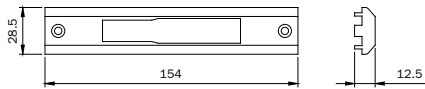

**All.Co** All.Co 5 Reversibile  
All.Co 5 Sormonto  
**Esa** Giuntall Complanare

European cylinder striking plate for frames. In NYLON.  
For locks with **DEADBOLT AND DEVIATORS ONLY**  
for aluminium frames series 77\* - 78\*.

**038522** D 10 - 10

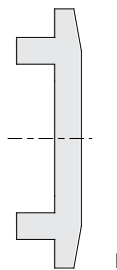

Full-size scale

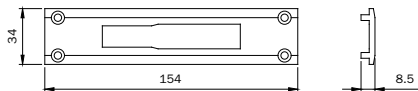

**Indinvest** Alpha 445 Porta 2 Ante  
**Metra** Nuovo Nc 50 Sormonto 1 Anta  
Nuovo Nc 50 Sormonto 2 Ante  
**Passerini** Ekip 50 Sormonto 1 Anta

European cylinder striking plate for frames. In NYLON.  
For locks with **DEADBOLT AND DEVIATORS ONLY**  
for aluminium frames series 77\* - 78\*.

**038523** D 10 - 10

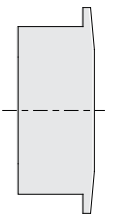

Full-size scale

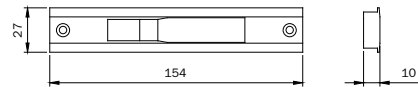

**Alcan** Albitnal Porta  
Winner Porta  
**All.Co** All.Co 5 Porta  
All.Co 5 Tl Porta  
Export 50 Porta  
Export 50 Tl Porta  
Scicurbin 65  
**Alnor** Montreal Porta  
**Aluk** Alublindo  
N 45 Porta  
N 53 Porta  
N 55 Tl Porta  
N 62 Tl Porta  
**Alumec** Synthesis 60Tl Porta  
**Alususe** Alsec 2000 Porta 59  
Alsec 2000 Porta 69  
**Domal** Domal Break 52 Porta  
Domal Security Porta  
Domal Shops Porta  
Domal Stopper Pg Porta  
Metra Nc 45 International Porta  
Nc 45 Superthermic Porta  
Nc 55 International Porta  
Nc 68 Superthermic Porta  
Nuovo Nc 50 Porta  
Superlindo  
**Passerini** Ekip Maastricht 53 Porta 1 Anta  
Ekip Maastricht 53 Porta 2 Ante  
Ekip Maastricht Th 60 Porta 1 Anta  
Ekip Maastricht Th 60 Porta 2 Ante  
Ekip Maastricht Th 68 Porta 1 Anta  
Ekip Maastricht Th 68 Porta 2 Ante  
Ekip Thermo 53 Porta  
**Schiuco** Royal 78 St Blindato  
**Wicona** L60-A  
L70A

Striking plates for DOUBLE-BIT and MAPPA CAMUNA  
rail frames. In NYLON. Suitable for **ALL VERSIONS**.  
For LOCKS series 981 - 983 - 961 - 963

**038911** D 10 - 10

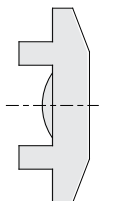

Full-size scale

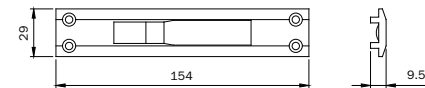

**Alcoa** R 40 Reversibile 1 Anta  
R 40 Reversibile 2 Ante  
R 40 Sormonto 1 Anta  
R 40 Sormonto 2 Ante  
R 50 Sormonto 1 Anta  
R 50 Sormonto 2 Ante  
R 50 Tl Sormonto 1 Anta  
R 50 Tl Sormonto 2 Ante  
R 60 Tl Complanare  
New Tec New Tec 50 Porta Sormonto  
New Tec 52 Tl Porta Sormonto  
New Tec 60 Tl Porta Sormonto  
New Tec 68 Tl Porta Sormonto

Striking plates for DOUBLE-BIT and MAPPA CAMUNA  
rail frames. In NYLON. Suitable for **ALL VERSIONS**  
For LOCKS series 981-983-961-963

**038912** D 10 - 10



Code

Min. ord.  
Multiple  
package  
Single  
package  
Status

**In nylon  
for metal frames**

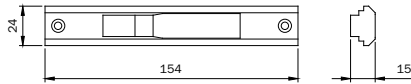
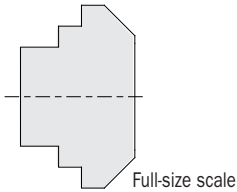

Alcoa Plana 2 Ante  
Indinvest Alpha 255 Complanare  
Alpha 370 Tt Complanare  
Alpha Blitz 2000  
Alpha Globo 55  
Passerini Ekip 50 Complanare 2 Ante

Striking plates for DOUBLE-BIT and MAPPA CAMUNA rail frames. In NYLON. Suitable for **ALL VERSIONS**.  
For LOCKS series 981-983-961-963

**038913** D 10 - 10

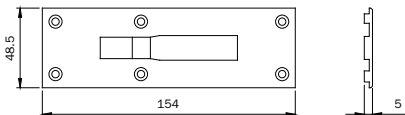
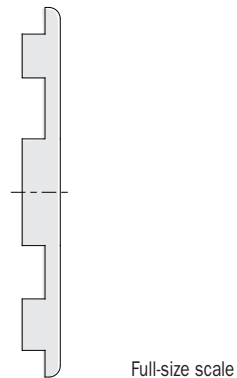

Alcoa Fb 12 Trad./Revamping

Striking plates for DOUBLE-BIT and MAPPA CAMUNA rail frames. In NYLON. Suitable for **ALL VERSIONS**.  
For LOCKS series 981-983-961-963

**038914** D 10 - 10

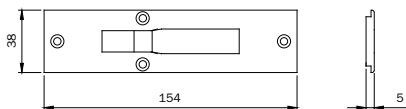
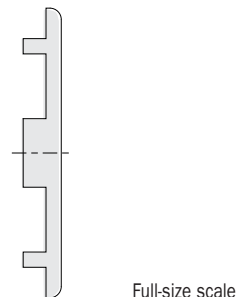

Alcoa Fb 12 Blindato  
Gr 9  
Plana 1 Ante  
Esa Blindal 60 Porta 1 Ante  
Blindal 60 Porta 2 Ante

Striking plates for DOUBLE-BIT and MAPPA CAMUNA rail frames. In NYLON. Suitable for **ALL VERSIONS**.  
For LOCKS series 981 - 983 - 961 - 963

**038915** D 10 - 10

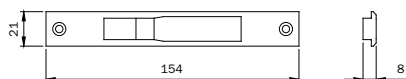
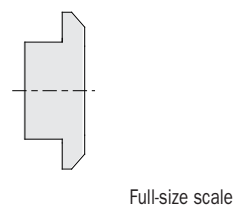

Alcan Abithal Cristal  
Abithal Keeper Porta C.E. / Winner Finestra  
Alcoa Fb 12 Ga / Europa Ga  
Fb 12 T.T. / R 35 Reversibile  
R 35 Sormonto  
All.Co Export 40 Finestra  
Export 50 Finestra / Export 50 Tt Finestra  
Final 40 Finestra  
Alu-mec Synthesis 45 Finestra  
Synthesis 57 Finestra  
Synthesis 60 Tt Finestra  
Alusuisse Alsec 2000 Finestra 59  
Alsec 2000 Finestra 69  
Bohaga Gga 50 / New Et 60  
Domal Domal Break 52 Finestra  
Domal Break 70 Finestra  
Domal Stopper Pg Finestra  
EQUIPE Sistema 8000 G.A. Finestra 1 Ante  
Sistema 8000 G.A. Finestra 2 Ante  
Esa Isola Porta  
Esedra Ga 53 Porta / Tt 63 Porta / Tt 75 Porta  
Indinvest Gold 400 Complanare  
Gold 400 Sormonto / Gold 500 Complanare  
Gold 500 Sormonto / Gold 600 Complanare  
Gold 600 Sormonto  
Mitra Nc 45 International Finestra  
Nc 45 Superthermic Finestra  
Nc 55 International Finestra  
Nc 68 Superthermic Finestra  
Morelli Ma 8300  
Ocma Fc 47 Finestra / Fc 55 Finestra  
Fc 60 Tt Finestra  
Passerini Ekip 40 Evoluzione 2 Ante  
Ekip 40 Sormonto 2 Ante  
Ekip 50 Sormonto 2 Ante  
Ekip Maastricht 53 Finestra  
Ekip Maastricht Th 60 Finestra  
Ekip Maastricht Th 68 Finestra  
Profilati \*Pe\* Eku 53 Finestra  
\*Pe\* Eku 64 Tt Finestra  
\*Pe\* Eku 72 Tt Finestra

Striking plates for DOUBLE-BIT and MAPPA CAMUNA rail frames. In NYLON. Suitable for **ALL VERSIONS**.  
For LOCKS series 981 - 983 - 961 - 963

**038919** D 10 - 10



Code

Min. ord.  
Multiple  
package  
Single  
package  
Status

**In nylon  
for metal frames**

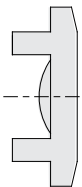

Full-size scale

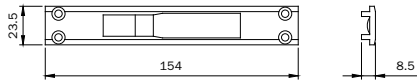

Striking plates for DOUBLE-BIT and MAPPA CAMUNA rail frames. In NYLON. Suitable for **ALL VERSIONS**.

For LOCKS series 981 - 983 - 961 - 963

All.Co Ites P4 Sormonto  
Metra Nuovo Nc 40 Sormonto 1 Anta  
Passerini Ekip 40 Evoluzione 1 Anta  
Ekip 40 Sormonto 1 Anta  
Profilati Sistema Pe 1 40 Comp./Est. 1 Anta  
Sistema Pe 1 40 Sormonto 1 Anta  
Sistema Pe 1 50 Comp./Est. 1 Anta  
Sistema Pe 1 50 Sormonto 1 Anta

**038920** D 10 - 10

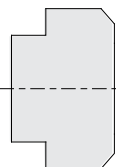

Full-size scale

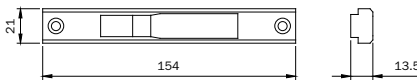

Striking plates for DOUBLE-BIT and MAPPA CAMUNA rail frames. In NYLON. Suitable for **ALL VERSIONS**.

For LOCKS series 981 - 983 - 961 - 963

Alcoa Formula F40 Porta / Formula F40 Tl Porta  
Formula F50 Porta / Formula F50 Tl Porta / Formula F60 Tl Porta  
All.Co All.Co 5 Complanare / Ites P4 Complanare  
Alnor Glindo Block / Montreal G.A.  
Alu-k N 53 Complanare / N 55 Tl Complanare  
Alu-mec Synthesis 57 Porta  
Bodega Extrablind 70  
Domal Domal Break 70 Porta  
Esa Giuntall Porta  
Indinvest Alpha 445 Finestra / Alpha 445 Porta 1 Anta Alpha Globo 45  
Metra Nuovo Nc 40 Complanare / Nuovo Nc 40 Sormonto 2 Ante  
New Tec New Tec 50 Porta Complanare  
New Tec 52 Tl Porta Complanar / New Tec 68 Tl Porta Complanare  
Ocma Tc 60 Tl Porta  
Passerini Ekip 40 Complanare 1 Anta / Ekip 40 Complanare 2 Ante  
Ekip Thermo 53 Finestra 2 Ante  
Profilati "Pe "Eku 53" Porta" / "Pe "Eku 64 Tl" Porta"  
"Pe "Eku 72 Tl" Porta" / Sistema Pe 1 40 Comp./Est. 2 Ante  
Sistema Pe 1 40 Sormonto 2 Ante  
Sistema Pe 1 50 Comp./Est. 2 Ante  
Sistema Pe 1 50 Sormonto 2 Ante

**038921** D 10 - 10

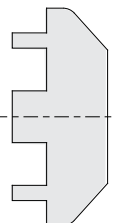

Full-size scale

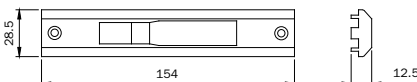

Striking plates for DOUBLE-BIT and MAPPA CAMUNA rail frames. In NYLON. Suitable for **ALL VERSIONS**.

For LOCKS series 981 - 983 - 961 - 963

All.Co All.Co 5 Reversibile  
All.Co 5 Sormonto  
Esa Giuntall Complanare

**038922** D 10 - 10

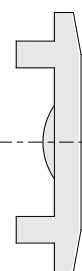

Full-size scale

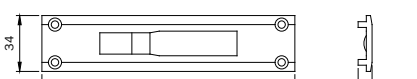

Striking plates for DOUBLE-BIT and MAPPA CAMUNA rail frames. In NYLON. Suitable for **ALL VERSIONS**.

For LOCKS series 981 - 983 - 961 - 963

Indinvest Alpha 445 Porta 2 Ante  
Metra Nuovo Nc 50 Sormonto 1 Anta  
Nuovo Nc 50 Sormonto 2 Ante  
Passerini Ekip 50 Sormonto 1 Anta

**038923** D 10 - 10

**In nylon for locks with oval cylinder**



Full-size scale

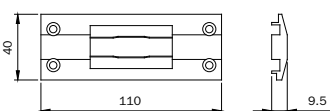

Oval-cylinder striking plate for rail frames. In NYLON.

For LOCKS series 550 - 551 - 70\* - 71\* - 730 - 731

GR 9 type

**033025** D 10 - 10





Code

Min. ord.  
Multiple  
package  
Single  
package  
Status

**In nylon  
for metal frames**

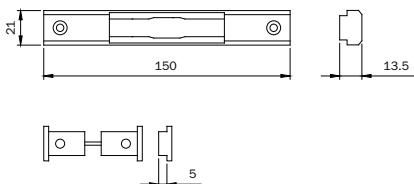
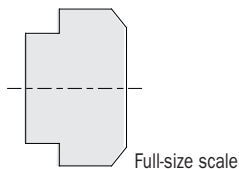

**All.Co** All.Co 5 Complanare / All.Co 5 Complanare  
All.Co 5 Complanare / Ites P4 Complanare  
Ites P4 Complanare  
**Alnor** Montreal G.A.  
**Ali-k** N 45 Complanare / N 53 Complanare  
N 55 Tt Complanare  
**Esa** Giuntall Complanare / Giuntall Complanare  
Giuntall Complanare / Giuntall Complanare  
Giuntall Sormonto / Giuntall Sormonto  
Giuntall Sormonto / Giuntall Sormonto  
Isola Complanare / Isola Sormonto  
**Indinvest** Alpha 445 Finestra  
Alpha 445 Finestra  
Alpha Globo 45  
Alpha Globo 45  
**Metra** Nuovo Nc 40 Complanare  
Nuovo Nc 40 Complanare  
Nuovo Nc 40 Sormonto 2 Ante  
Nuovo Nc 40 Sormonto 2 Ante  
Nuovo Nc 50 Complanare  
Nuovo Nc 50 Complanare  
**Passerini** Ekip Thermo 53 Finestra 2 Ante  
Ekip Thermo 53 Finestra 2 Ante

Oval-cylinder striking plate for rail frames. In NYLON.  
For LOCKS series 550 - 551 - 70\* - 71\* - 730 - 731

**033026** D 10 - 10

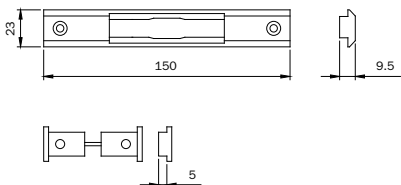
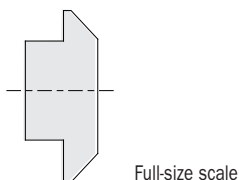

**Alcan** Abithal Finestra / Abithal Finestra  
Abithal Finestra / Winner Finestra  
**Alcoa** Fb 12 Ga / Europa Ga  
Fb 12 Ga / Europa Ga / Fb 12 T.T. / Fb 12 T.T.  
R 35 Reversible / R 35 Sormonto  
**All.Co** Export 40 Finestra / Export 50 Finestra  
Export 50 Finestra  
**Alu-mec** Synthesis 45 Finestra  
Synthesis 57 Finestra  
Synthesis 60 Tt Finestra  
**Bodega** Bga 50 / Bga 50 / Bga 50  
**Domal** Domal Break 52 Finestra  
Domal Stopper Pg Finestra  
**Equip** Sma 40 W  
Sistema 8000 G.A. Finestra 1 Ante  
Sistema 8000 G.A. Finestra 2 Ante  
**Esa** Ga 53 Porta / Ga 53 Porta  
Ga 53 Porta / Tt 63 Porta  
**Indinvest** Gold 400 Complanare  
Gold 400 Sormonto  
Gold 500 Complanare  
Gold 500 Sormonto  
**Metra** Nc 45 International Finestra  
Nc 45 International Finestra  
Nc 45 International Finestra  
Nc 45 Superthermic Finestra  
Nc 45 Superthermic Finestra  
Nc 45 Superthermic Finestra  
**Morelli** Ma 8300  
**Ocma** Fc 47 Finestra / Fc 55 Finestra  
Fc 55 Finestra / Fc 60 Tt Finestra  
**Passerini** Ekip 40 Evoluzione 2 Ante  
Ekip 40 Evoluzione 2 Ante  
Ekip 40 Sormonto 2 Ante  
Ekip 40 Sormonto 2 Ante  
Ekip 50 Sormonto 2 Ante  
Ekip 50 Sormonto 2 Ante  
Ekip Maastricht 53 Finestra

Oval-cylinder striking plate for rail frames. In NYLON.  
For LOCKS series 550 - 551 - 70\* - 71\*  
730 - 731 - 736 - 737

**033027** A 10 - 10

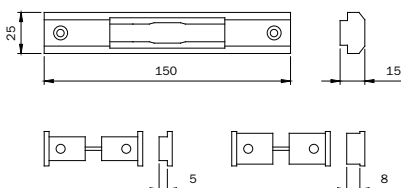
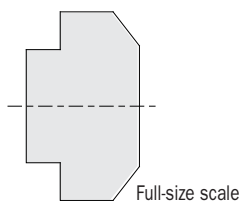

**Alcoa** Plana 2 Ante  
Plana 2 Ante  
**Domal** Domal 40 Sormonto 2 Ante  
Domal 40 Sormonto 2 Ante  
**Indinvest** Alpha 255 Complanare  
Alpha 255 Complanare  
Alpha Globo 55  
Alpha Globo 55

Oval-cylinder striking plate for rail frames. In NYLON.  
For LOCKS series 550 - 551 - 70\* - 71\*  
730 - 731 - 736 - 737

**033028** D 10 - 10

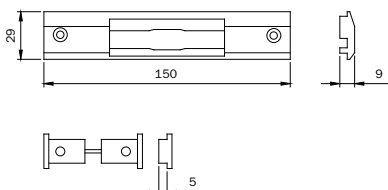
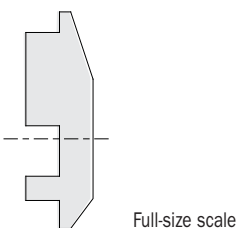

**All.Co** Ites P4 Sormonto  
Ites P4 Sormonto  
**Domal** Domal 40 Sormonto 1 Ante  
Domal 40 Sormonto 1 Ante  
**Metra** Nuovo Nc 40 Sormonto 1 Ante  
Nuovo Nc 40 Sormonto 1 Ante  
Nuovo Nc 40 Sormonto 1 Ante  
**Passerini** Ekip 40 Evoluzione 1 Ante  
Ekip 40 Evoluzione 1 Ante  
Ekip 40 Sormonto 1 Ante  
Ekip 40 Sormonto 1 Ante  
Ekip 50 Sormonto 1 Ante  
Ekip 50 Sormonto 1 Ante

Oval-cylinder striking plate for rail frames. In NYLON.  
For LOCKS series 550 - 551 - 556 - 70\* - 71\*  
730 - 731 - 736 - 737

**033029** A 10 - 10



Code

Min. ord.  
Multiple  
package  
Single  
package  
Status

**In nylon  
for metal frames**

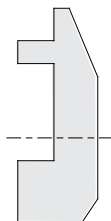

Full-size scale

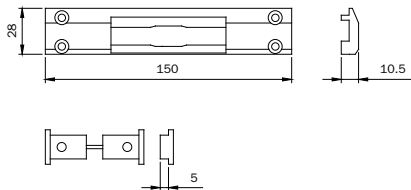

All.Co All.Co 5 Reversibile  
All.Co 5 Reversibile  
All.Co 5 Reversibile  
All.Co 5 Sormonto  
All.Co 5 Sormonto  
All.Co 5 Sormonto  
Metra Nuovo Nc 50 Sormonto 1 Anta / 2 Ante  
Nuovo Nc 50 Sormonto 1 Anta / 2 Ante  
Nuovo Nc 50 Sormonto 1 Anta / 2 Ante

Oval-cylinder striking plate for rail frames. In NYLON.  
For LOCKS series 550 - 551 - 70\* - 71\*  
730 - 731 - 736 - 737

**033030** B 10 - 10



Full-size scale

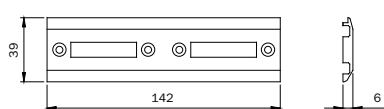

da mm 40

ALL.CO:  
Vz 400/400S  
ALNOR:  
400  
ALU-MEC:  
F 40  
BODEGA:  
Bo 40/900  
ESA:  
Nt 40G  
METRA:  
Nc 40

Oval-cylinder striking plate for frames. In NYLON.  
For LOCKS with **DEADBOLT AND LATCHBOLT ONLY**  
series 750 - 751 - 752 - 753

**033040** D 10 - 10

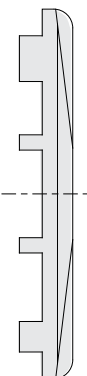

Full-size scale

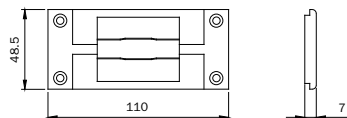

Alcoa Plano 1 Anta / Plano 1 Anta  
All.Co Vz 500 / Vz 400 P / Vz 500 / Vz 400 P  
Vz 500 / Vz 400 P / Vz 500 / Vz 400 P  
Alnor 500 / 500 / 500  
Alu-mec F 50 / F 50 / F 50  
Bodega Bo 40 / 900  
Bo 40 / 900  
Esa Nt 50 G  
Nt 50 G  
Esedra 50 Piano  
50 Piano  
50 Piano  
Fresia Fl 50  
Indinvest Te 50  
Te 50  
Te 50  
Te 50  
Metra Nc 50 B  
Nc 50 B  
Nc 50 B  
Nc 50 B  
Passerini T.G.P. 50  
T.G.P. 50  
T.G.P. 50

Oval-cylinder striking plate for rail frames. In NYLON.  
For LOCKS series 550 - 551 - 556 - 70\* - 71\* - 730 - 731

**033050** D 10 - 10

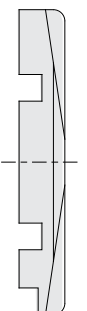

Full-size scale

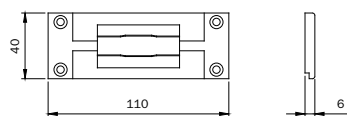

Alcoa Fb 12 Trad./Revamping  
Fb 12 Trad./Revamping  
Fb 12 Trad./Revamping  
Gr S  
Gr S  
All.Co Vz 400 / Vz 400 S  
Vz 400 / Vz 400 S  
Alnor 400  
400  
Alu-mec F 40  
F 40  
Bodega Bo 50  
Bo 50  
Esa Nt 40 G  
Nt 40 G  
Esedra 40 Piano  
Fresia Fl 40  
Fl 40  
Indinvest Te 40/45  
Te 40/45  
Metra Nc 40 / 40 L  
Nc 40 / 40 L  
Passerini T.G.P. 40  
T.G.P. 40

Oval-cylinder striking plate for rail frames. In NYLON.  
For LOCKS series 550 - 551 - 70\* - 71\* - 730 - 731

**033051** B 10 - 10



Code

Min. ord.  
Multiple  
package  
Single  
package  
Status

**In nylon  
for metal frames**

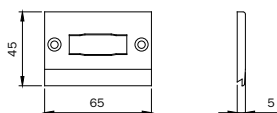
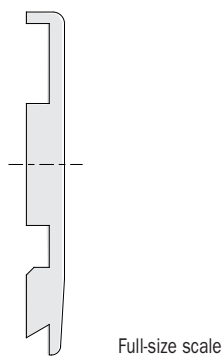

da mm 50

ALLCO:  
VZ 500/500P  
ALNOR:  
500  
ALLMEC:  
F 50  
BODEGA:  
BO 50  
ESA:  
NT 50G  
METRA:  
NC 50B

Oval-cylinder striking plate for frames. In NYLON.

For LOCKS with **LATCHBOLT OR ROLLER ONLY** 762 - 764

**033060** D 10 - 10

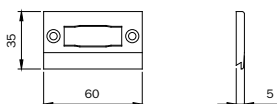
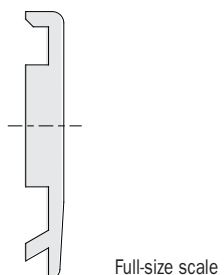

da mm 40

ALLCO:  
VZ 400/400S  
ALNOR:  
400  
ALLMEC:  
F 40  
BODEGA:  
BO 40/500  
ESA:  
NT 40G  
METRA:  
NC 40

Oval-cylinder striking plate for frames. In NYLON.

For LOCKS with **LATCHBOLT OR ROLLER ONLY** 762 - 764

**033061** D 10 - 10

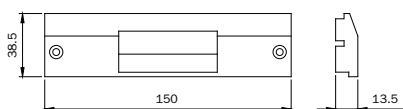
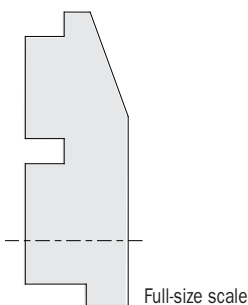

da mm 50

METRA: NC 50 international

Oval-cylinder striking plate for rail frames. In NYLON.

For LOCKS series 550 - 551 - 556 - 70\* - 71\* - 73\*

730 - 731 - 766 - 767

**033062** D 10 - 10

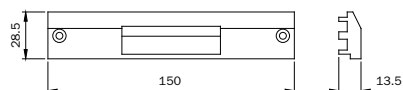
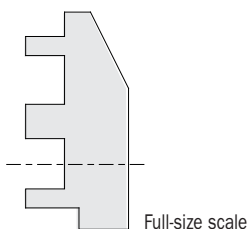

da mm 40

METRA: NC 40 international

Oval-cylinder striking plate for rail frames. In NYLON.

For LOCKS series 550 - 551 - 556 - 70\* - 71\* - 73\*

730 - 731 - 766 - 767

**033063** D 10 - 10

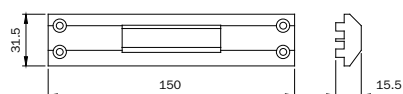
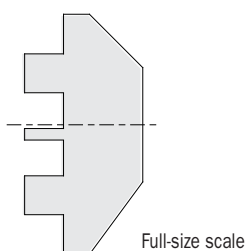

Alcoa R 50 Sormonto 1 Anta / 2 Ante  
R 50 Sormonto 1 Anta / 2 Ante  
R 50 Ti Sormonto 1 Anta / 2 Ante  
R 50 Ti Sormonto 1 Anta / 2 Ante  
Esa Nt 45 G 2 Ante  
Nt 45 G 2 Ante  
Nt 45 G 2 Ante

Oval-cylinder striking plate for rail frames. In NYLON.

For LOCKS series 550 - 551 - 556 - 70\* - 71\* - 73\*

730 - 731 - 766 - 767

**033064** D 10 - 10



Code

Min. ord.  
Multiple  
package  
Single  
package  
Status

**In nylon  
for metal frames**

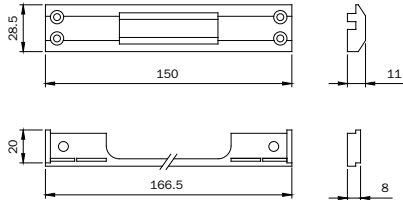
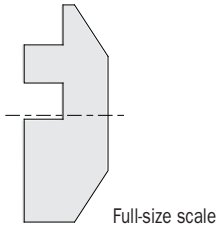

Alcoa R 40 Reversibile 1 Anta / 2 Ante  
R 40 Reversibile 1 Anta / 2 Ante  
R 40 Reversibile 1 Anta / 2 Ante  
R 40 Sormonto 1 Anta / 2 Ante  
R 40 Sormonto 1 Anta / 2 Ante  
R 40 Sormonto 1 Anta / 2 Ante  
R 50 Sormonto 1 Anta / 2 Ante  
R 50 Sormonto 1 Anta / 2 Ante  
R 50 Tt Sormonto 1 Anta / 2 Ante  
R 50 Tt Sormonto 1 Anta / 2 Ante  
R 60 Tt Complanare  
Esa Nt 45 G 1 Anta  
Nt 45 G 1 Anta  
Nt 45 G 1 Anta

Oval cylinder striking plate for rail frames. In NYLON.  
For LOCKS series 550 - 551 - 556 - 70\* - 71\* - 73\*  
730 - 731

**033065** A 10 - 10

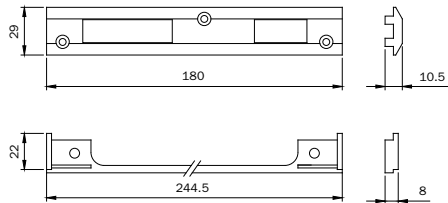
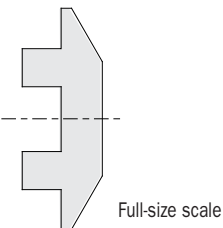

da mm 50  
ALCOA: R 40 / R 50

European cylinder striking plate for frames.  
In NYLON. For LOCKS with **DEADBOLT AND LATCHBOLT**  
series 7 741 - 743 - 745 - 749 - 200 - 205 - 221 - 240 - 250

**033066** B 10 - 10

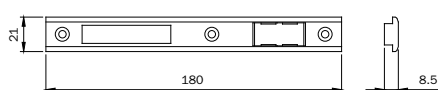
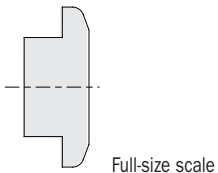

camera europea  
ALCAN : Winner finestra  
ALCOA: FB 12 TT / SE G.A.  
ALU-MEC: Synthesis 45 / 57 / 60TT  
ALUSUISSE: Alsec 2000 fin.59/69  
BODEGA : BGA 50 / New BT60  
DOMAL: Domal Stopper PG fin.  
Domal Break 52 finestra  
Domal Break 70 finestra  
EQUIPE : Sistema 8000-Emal 40 W  
ESA : Isola porta  
ESEDRA: G 53 comp.  
TT63 comp. - TT 75 comp.  
FINAL: Export 50 finestra  
Export 50TT finestra  
INDINVEST: Gold 400 / 500 / 600  
ITES: Export 40finestra  
MORELLI: MA 8300  
OCMA: FC 55 finestra  
PASSERINI: Ekip 40 sorm. 2 ante  
Ekip 40 evoluzione 2 ante  
Ekip 50 sormonto 2 ante  
Ekip thermo

European cylinder striking plate for frames.  
In NYLON. For LOCKS with **DEADBOLT AND LATCHBOLT**  
series 741 - 743 - 745 - 749 - 200 - 205 - 221 - 240 - 250

**033067** C 10 - 10

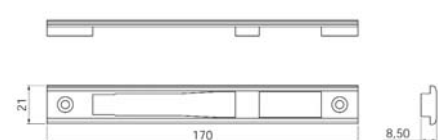
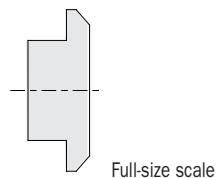

Alcan Abithal Cristal / Abithal Keeper Porta C.E  
Winner Finestra  
Alcoa Fb 12 Ga / Europa Ga / Fb 12 T.T. / R 35 Reversibile  
R 35 Sormonto  
All.Co Export 40 Finestra / Export 50 Finestra  
Export 50 Tt Finestra / Final 40 Finestra  
Alu-mec Synthesis 45 Finestra / Synthesis 57 Finestra  
Synthesis 60 Tt Finestra  
Alusuisse Alsec 2000 Finestra 59 / Alsec 2000 Finestra 69  
Bodega Bga 50 / New Bt 60  
Domal Domal Break 52 Finestra / Domal Break 70 Finestra  
Domal Stopper Pg Finestra  
EquipSistema 8000 G.A. Finestra 1 Anta  
Sistema 8000 G.A. Finestra 2 Ante  
Esa Isola Porta  
Esdra Ga 53 Porta / Tt 63 Porta / Tt 75 Porta  
Indinvest Gold 400 Complanare / Gold 400 Sormonto  
Gold 500 Complanare / Gold 500 Sormonto  
Gold 600 Complanare / Gold 600 Sormonto  
Metra Nc 45 International Finestra  
Nc 45 Superthermic Finestra / Nc 55 International Finestra  
Nc 68 Superthermic Finestra  
Morelli Ma 8300  
Ocma Fc 47 Finestra / Fc 55 Finestra / Fc 60 Tt Finestra  
Passerini Ekip 40 Evoluzione 2 Ante  
Ekip 40 Sormonto 2 Ante / Ekip 50 Sormonto 2 Ante  
Ekip Maasricht 53 Finestra / Ekip Maasricht Tt 60 Finestra  
Ekip Maasricht Tt 68 Finestra  
Profilati "Pe "Eku 53" Finestra" / "Pe "Eku 64 Tt"  
Finestra"  
"Pe "Eku 72 Tt" Finestra"

European cylinder striking plate for frames.  
In NYLON. For LOCKS with **DEADBOLT AND LATCHBOLT, ROLLER, ELECTRIC**  
with handle for series 78\*.

**033149** D 10 - 10



Code

Status

Single  
package

Multiple  
package

Min. ord.

**In nylon  
for metal frames**

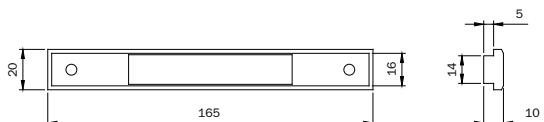

Oval cylinder front plate support for rail frames with front plate mm 16. In NYLON.

**033071** B 10 - 10

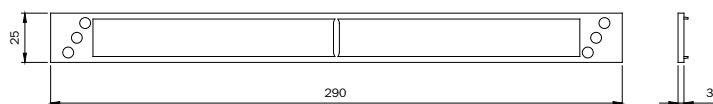

Front plate support in NYLON **290x25** For LOCKS for European cylinder aluminium frames.

**038002** B 10 - 10

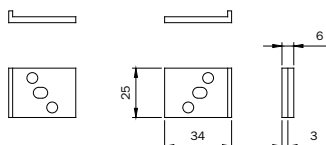

Pair of front plate support spacers in NYLON **25x6**, For locks with European cylinder aluminium frames and double-bit rail frames.

**038004** D 10 - 10

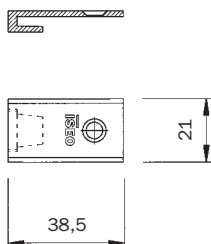

Loading spring slide for electric locks for striking plates series 03803\*- 03807\*-038101-038102-038103

**990841** B 10 - 10

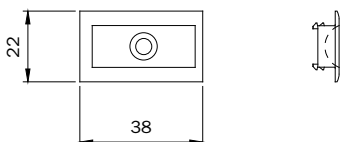

Nylon insert to be used with roller locks series 78\* and striking plates 03860\*

**040880** B 10 - 10

## Legend

[1]	Use front plate support spacer mm 3: - for locks for frames (lateral and 3-point locking Electa): <b>Art. 038002</b> - for double-bit locks for rail frames: <b>Art. 038004</b>
[2]	Use the striking plate without fitting the nylon caps.
[3]	Use front plate support mm 8 <b>Art. 038019</b>
[4]	Use front plate support mm 8 <b>Art. 033071</b>
[5]	For electric versions use the loading spring slide <b>Art. 990841</b> (only for lateral, 3-point locking and flat multipunto)
[6]	For electric versions use pair of front plate supports mm 3 <b>Art. 038004</b> (only for lateral and 3-point locking Electa)
[7]	Multipoint assembly recommended for mechanical versions only
[8]	For electric locks use version with extended latchbolt mm 5 (only for 3-point locking and Electa versions)
[9]	You can use stainless steel striking plates 22x1,5 <b>Art. 038035</b> for versions with deadbolt + latchbolt/roller and electric versions with handle follower <b>Art. 038025</b> for versions with deadbolt only or for deviators
[10]	Only use versions with 22 mm front plate
[11]	The electric version cannot be installed
[12]	For Multiblindo locks: the assembly only applies to the lateral version
[13]	For Multiblindo locks: the version with hook deviators cannot be installed
[14]	For Multiblindo locks: for roller versions the striking plate must be assembled without the nylon slide
[15]	Locks for rail frames: you can only assemble locks with a case height of 44 mm <b>Art. 704 - 708</b>
[*]	The tables show the ideal backset relating to the used frame (1= Basic frame 2, 3, 4= Oversized frames)

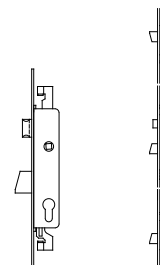

**Mortice locks  
center distance 85 mm**

FRAME MANUFACTURER	PROFILE	CYLINDER	FRONT PLATE USABLE BACKSET	STRIKING PLATES												
				ADJUSTABLE		STEEL		MULTIPOINT			NYLON					
FRAME (*)	C	D	24X7 24X6	24X3	22X3	DEADBOLT LATCHBOLT/ROLLER AND ELECTRIC	DEADBOLT AND DEVIATORS ONLY	DEADBOLT LATCHBOLT/ROLLER AND ELECTRIC	DEADBOLT AND DEVIATORS ONLY	WITHOUT TIPS	WITH TIPS	FLAT	DEADBOLT LATCHBOLT/ROLLER AND ELECTRIC	DEADBOLT ONLY HOOK AND DEVIATORS ONLY		
ALCAN	ABITHAL CRISTAL	2	30	50		E35	E35	0386011	0387011	038031[5,9]	038021[9]	/	/	038074[5]	038319	038519
	ABITHAL KEEPER PORTA 53-60	1	30	40			E25	0386001	0387001	/	/	/	/	/	/	/
	ABITHAL KEEPER PORTA 61-68	1	30	45			E25	0386001	0387001	/	/	/	/	/	/	/
	ABITHAL KEEPER PORTA C.E.	2	30	45		E30	E30	0386011	0387011	038031[5,9]	038021[9]	/	/	038074[5]	038319	038519
	ABITHAL PORTA	1	28	28	E30		E25	0386001	0387001	/	/	038073	038071	/	038011[1]	038511
	WINNER FINESTRA	2	28	40		E25	E25	0386011	0387011	038031[5,9]	038021[9]	/	/	038074[5]	038319	038519
	WINNER PORTA	1	28	28	E25		E25	0386001	0387001	/	/	038072	038070	/	038011[1]	038511
ALCOA	ALUBLIND	1	30	80		E30	E30	0386021	0387021	/	/	/	/	/	038012	038512
	FB 12 BLINDATO	1	28	33			E30	0386001	0387001	038030[5]	038020	/	/	/	038015[1]	038515
	FB 12 GA / EUROPA GA	2	28	33		E25	E25	0386011	0387011	038031[5,9]	038021[9]	/	/	038074[5]	038319	038519
	FB 12 T.T.	1	28	40		E25	E25	0386011	0387011	038031[5,9]	038021[9]	/	/	038074[5]	038319	038519
	FB 12 TRAD./REVAMPING	3	28	28			E25	/	/	038030[5]	038020	/	/	/	038014[1]	038514
	FORMULA F40 PORTA	1	28	33	E30		E30	0386001	0387001	/	/	038073	038071	/	038321[1]	038521
	FORMULA F40 TT PORTA	1	30	35	E25		E25	0386001	0387001	/	/	038073	038071	/	038321[1]	038521
	FORMULA F50 PORTA	1	30	40	E30		E30	0386001	0387001	/	/	038073	038071	/	038321[1]	038521
	FORMULA F50 TT PORTA	1	30	40	E25		E25	0386001	0387001	/	/	038073	038071	/	038321[1]	038521
	FORMULA F60 TT PORTA	1	30	50	E25		E25	0386001	0387001	/	/	038073	038071	/	038321[1]	038521
	GR 9	2	28	28	E25		E25	/	/	038030[5]	038020	/	/	/	038015[1]	038515
	PLANA 1 ANTA	2	28	28			E25	0386001	0387001	038030[5]	038020	/	/	/	038015	038515
	PLANA 2 ANTE	2	28	28			E25	0386001	0387001	/	/	/	/	/	038013	038513
	R 35 REVERSIBILE	2	28	28			E25	0386011	0387011	038031[5,9]	038021[9]	/	/	/	038319	038519
	R 35 SORMONTO	2	28	28			E25	0386011	0387011	038031[5,9]	038021[9]	/	/	/	038319	038519
	R 40 REVERSIBILE 1 ANTA	2	28	33	E30		E30	0386021	0387021	/	/	/	/	/	038012	038512
	R 40 REVERSIBILE 2 ANTE	2	28	33	E30		E30	0386021	0387021	/	/	/	/	/	038012	038512
	R 40 SORMONTO 1 ANTA	2	28	28	E25		E25	0386021	0387021	/	/	/	/	/	038012	038512
	R 40 SORMONTO 2 ANTE	2	28	28	E25		E25	0386021	0387021	/	/	/	/	/	038012	038512
	R 50 SORMONTO 1 ANTA	2	28	28	E30		E30	0386021	0387021	/	/	/	/	/	038012	038512
R 50 SORMONTO 2 ANTE	2	28	28	E30		E30	0386021	0387021	/	/	/	/	/	038012	038512	
R 50 TT SORMONTO 1 ANTA	2	28	28	E30		E30	0386021	0387021	/	/	/	/	/	038012	038512	
R 50 TT SORMONTO 2 ANTE	2	28	28	E30		E30	0386021	0387021	/	/	/	/	/	038012	038512	
R 60 TT COMPLANARE	2	30	45	E30		E30	0386021	0387021	/	/	/	/	/	038012	038512	
ALLCO FINAL ITES	ALLCO 5 COMPLANARE	2	28	28		E25	E25	0386031	0387031	/	/	/	/	/	038321[8]	038521
	ALLCO 5 PORTA	1	28	28	E30		E30	0386001	0387001	/	/	038072	038070	/	038011[1]	038511
	ALLCO 5 REVERSIBILE	2	28	28		E25	E25	0386021	0387021	/	/	/	/	/	038322	038522
	ALLCO 5 SORMONTO	2	28	28		E30	E30	0386021	0387021	/	/	/	/	/	038322	038522
	ALLCO 5 TT PORTA	1	30	45	E30		E30	0386001	0387001	/	/	038072	038070	/	038011[7]	038511
	EXPORT 40 FINESTRA	2	30	40		E30	E30	0386011	0387011	038031[5,9]	038021[9]	/	/	038074[5]	038319	038519
	EXPORT 45 TT	2	30	45		E30	E30	0386011	0387011	/	/	/	/	/	/	/
	EXPORT 50 FINESTRA	2	30	45		E30	E30	0386011	0387011	038031[5,9]	038021[9]	/	/	038074[5]	038319	038519
	EXPORT 50 PORTA	1	30	35	E30		E30	0386001	0387001	/	/	038072	038070	/	038011[1]	038511
	EXPORT 50 TT FINESTRA	2	30	55		E30	E30	0386011	0387011	038031[5,9]	038021[9]	/	/	038074[5]	038319	038519
	EXPORT 50 TT PORTA	1	30	45			E30	0386001	0387001	/	/	/	/	/	038011[1]	038511
	FINAL 40 FINESTRA	2	30	35		E30	E30	0386011	0387011	038031[5,9]	038021[9]	/	/	038074[5]	038319	038519
	ITES P4 COMPLANARE	2	28	28		E25	E25	0386031	0387031	/	/	/	/	/	038321[8]	038521
ITES P4 SORMONTO	2	28	28		E25	E25	0386021	0387021	/	/	/	/	/	038320[8]	038520	
SICURBLIN 65	1	35	35	E30		E25	0386001	0387001	/	/	038072	038070	/	038011[6]	038511	
SICURBLIN C.E.	1	30	60		E30	E30	0386011	0387011	038031[5,9]	038021[9]	/	/	038074[5]	/	/	
ALNOR	BLINDO BLOCK	1	30	55		E35	E35	0386031	0387031	/	/	/	/	/	038321	038521
	MONTREAL G.A.	2	28	28		E25	E25	0386031	0387031	/	/	/	/	/	038321	038521
	MONTREAL PORTA	1	28	28	E25		E25	0386001	0387001	/	/	038072	038070	/	038011[1]	038511

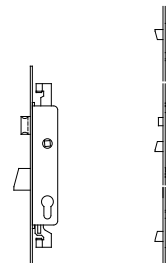

**Mortice locks  
center distance 85 mm**

PROFILE		CYLINDER		FRONT PLATE USABLE BACKSET			STRIKING PLATES									
FRAME MANUFACTURER	SERIES	FRAME (*)	C	D	24X7 24X6	24X3	22X3	ADJUSTABLE		STEEL		MULTIPOINT			NYLON	
								DEADBOLT LATCHBOLT/ROLLER AND ELECTRIC	DEADBOLT AND DEVIATORS ONLY	DEADBOLT LATCHBOLT/ROLLER AND ELECTRIC	SOLO CATENACCIO E DEVIATORI	WITHOUT TIPS	WITH TIPS	FLAT	DEADBOLT LATCHBOLT/ROLLER AND ELECTRIC	DEADBOLT ONLY HOOK AND DEVIATORS ONLY
ALUSUISSE	ALSEC 2000 FINESTRA 59	2	30	55		E25	E25	0386011	0387011	038031[5,9]	038021[9]	/	/	038074[5]	038319	038519
	ALSEC 2000 FINESTRA 69	2	30	65		E25	E25	0386011	0387011	038031[5,9]	038021[9]	/	/	038074[5]	038319	038519
	ALSEC 2000 PORTA 59	1	28	40				0386001	0387001	/	/	/	/	038011[1]	038511	038511
	ALSEC 2000 PORTA 59	1	30	50	E35			0386001	0387001	/	/	038073	038071	/	038011	038511
	ALSEC 2000 PORTA 69	1	30	55	E35		E30	0386001	0387001	/	/	038073	038071	/	038011[1]	038511
ALLUK	ALUBLINDO	1	45	45		E30	E30	0386001	0387001	/	/	038072	038070	/	038011[6]	038511
	N 45 PORTA	1	28	28		E30	E30	0386001	0387001	/	/	038072	038070	/	038011	038511
	N 45 REVERSIBLE	2	28	28		E25	E25	0386021	0387021	/	/	/	/	/	/	/
	N 53 COMPLANARE	2	30	35		E25	E25	0386031	0387031	/	/	/	/	/	038321	038521
	N 53 PORTA	1	28	33	E35		E35	0386001	0387001	/	/	038072	038070	/	038011	038511
	N 55 TT COMPLANARE	2	30	40		E25	E25	0386031	0387031	/	/	/	/	/	038321	038521
	N 55 TT PORTA	1	30	35	E35		E30	0386001	0387001	/	/	/	/	/	038011	038511
	N 62 TT PORTA	1	30	45	E35		E30	0386001	0387001	/	/	/	/	/	038011	038511
ALLUMEC	SYNTHESIS 45 FINESTRA	2	28	33		E35	E35	0386011	0387011	038031[5,9]	038021[9]	/	/	038074[5]	038319	038519
	SYNTHESIS 57 FINESTRA	2	28	33		E35	E35	0386011	0387011	038031[5,9]	038021[9]	/	/	038074[5]	038319	038519
	SYNTHESIS 57 PORTA	2	35	35	E35		E30	0386001	0387001	/	/	038072	038070	/	038012	038512
	SYNTHESIS 60 TT FINESTRA	2	30	45		E35	E35	0386011	0387011	038031[5,9]	038021[9]	/	/	038074[5]	038319	038519
	SYNTHESIS 60TT PORTA	2	30	40	E35		E35	0386001	0387001	/	/	038072	038070	/	038011	038511
BODEGA	BGA 50	2	30	40		E25	E25	0386011	0387011	038031[5,9]	038021[9]	/	/	038074[5]	038319	038519
	EXTRABLIND 70	2	35	45		E35	E35	0386001	0387001	/	/	/	/	/	038321[1]	038521
	EXTRABLIND 70	2	35	45	E35			0386001	0387001	/	/	038073	038071	/	038011	038511
	NEW BT 60	2	30	45		E25	E25	0386011	0387011	038031[5,9]	038021[9]	/	/	038074[5]	038319	038519
DOMAL	DOMAL BREAK 52 FINESTRA	2	30	40		E30	E30	0386011	0387011	038031[5,9]	038021[9]	/	/	038074[5]	038319	038519
	DOMAL BREAK 52 PORTA	1	30	35	E30		E25	0386001	0387001	/	/	038073	038071	/	038011[1]	038511
	DOMAL BREAK 70 FINESTRA	2	30	55		E30	E30	0386011	0387011	038031[5,9]	038021[9]	/	/	038074[5]	038319	038519
	DOMAL BREAK 70 PORTA	1	30	45	E25		E25	0386001	0387001	/	/	038073	038071	/	038321[6]	038521
	DOMAL SECURITY PORTA	1	45	45			E25	0386001	0387001	/	/	/	/	/	038011	038511
	DOMAL SECURITY PORTA	1	40	40	E35			0386001	0387001	/	/	038072	038070	/	038011	038511
	DOMAL SHOPS PORTA	1	30	40			E25	0386001	0387001	/	/	/	/	/	038011[1]	038511
	DOMAL SHOPS PORTA	1	30	45	E30		E25	0386001	0387001	/	/	038073	038071	/	038011	038511
	DOMAL STOPPER PG FINESTRA	2	30	40		E30	E30	0386011	0387011	038031[5,9]	038021[9]	/	/	038074[5]	038319	038519
	DOMAL STOPPER PG PORTA	1	28	28	E30		E25	0386001	0387001	/	/	038072	038070	/	038011[6]	038511
EQUIPE	SISTEMA 8000 G.A. FINESTRA 1 ANTA	2	30	30		E35	E35	0386011	0387011	038031[5,9]	038021[9]	/	/	038074[5]	038319	038519
	SISTEMA 8000 G.A. FINESTRA 2 ANTE	2	30	30		E35	E35	0386011	0387011	038031[5,9]	038021[9]	/	/	038074[5]	038319	038519
	SISTEMA 8000 TT FINESTRA 1 ANTA	2	30	50		E35	E35	0386011	0387011	/	/	/	/	/	/	/
	SISTEMA 8000 TT FINESTRA 2 ANTE	2	30	50		E35	E35	0386011	0387011	/	/	/	/	/	/	/
ESA	BLINDAL 60 PORTA 1 ANTA	2	35	35	E35		E30	0386001	0387001	038030[5,6]	038020	/	/	/	038015[6]	038515
	BLINDAL 60 PORTA 2 ANTE	2	35	35	E35		E30	0386001	0387001	038030[5,6]	038020	/	/	/	038015[6]	038515
	BLINDAL 70 PORTA 1 ANTA	1	35	50		E30	E30	0386001	0387001	№2 038030[5,6]	№2 038020	/	/	/	/	/
	BLINDAL 70 PORTA 2 ANTE	1	35	50		E30	E30	0386001	0387001	№2 038030[5,6]	№2 038020	/	/	/	/	/
	GIUNTALL COMPLANARE	2	28	33			E25	0386031	0387031	/	/	/	/	/	038322	038522
	GIUNTALL PORTA	1	28	28		E25	E25	0386021	0387021	/	/	/	/	/	038321	038521
	ISOLA PORTA	1	30	40	E25		E25	0386011	0387011	038031[5,9]	038021[9]	/	/	038074[5]	038319	038519
	ESEDRA	GA 53 PORTA	2	30	40		E30	E30	0386011	0387011	038031[5,9]	038021[9]	/	/	038074[5]	038319
GA 53 PORTA		3	30	40		E35	E35	0386011	0387011	038031[5,9]	038021[9]	/	/	038074[5]	038319	038519
TT 63 PORTA		2	30	50		E30	E30	0386011	0387011	038031[5,9]	038021[9]	/	/	038074[5]	038319	038519



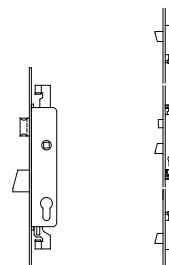

**Mortice locks  
center distance 85 mm**

PROFILE		CYLINDER		FRONT PLATE USABLE BACKSET			STRIKING PLATES									
FRAME MANUFACTURER	SERIES	FRAME (*)	C	D	24X7 24X6	24X3	22X3	ADJUSTABLE		STEEL		MULTIPOINT		NYLON		
								DEADBOLT LATCHBOLT/ROLLER AND ELECTRIC	DEADBOLT AND DEVIATORS ONLY	DEADBOLT LATCHBOLT/ROLLER AND ELECTRIC	DEADBOLT AND DEVIATORS ONLY	WITHOUT TIPS	WITH TIPS	FLAT	DEADBOLT LATCHBOLT/ROLLER AND ELECTRIC	DEADBOLT ONLY HOOK AND DEVIATORS ONLY
	TT 63 PORTA	3	30	50		E35	E35	0386011	0387011	038031[5/9]	038021[9]	/	/	038074[5]	038319	038519
	TT 75 PORTA	2	30	60		E30	E30	0386011	0387011	038031[5/9]	038021[9]	/	/	038074[5]	038319	038519
	TT 75 PORTA	3	30	60		E35	E35	0386011	0387011	038031[5/9]	038021[9]	/	/	038074[5]	038319	038519
FRESIA	GLOBAL 41 COMPLANARE	2	28	33		E30	E30	0386021	0387021	/	/	/	/	/	/	/
	GLOBAL 41 SORMONTO	2	28	33		E30	E30	0386021	0387021	/	/	/	/	/	/	/
	GLOBAL 48 COMPLANARE	2	30	40		E30	E30	0386021	0387021	/	/	/	/	/	/	/
	GLOBAL 48 PORTA	1	30	30		E25	E25	0386001	0387001	/	/	/	/	/	/	/
	GLOBAL 48 SORMONTO	2	30	30		E30	E30	0386021	0387021	/	/	/	/	/	/	/
	GLOBAL 70 TAGLIO TERMICO	2	30	45		E30	E30	0386021	0387021	/	/	/	/	/	/	/
INDINVEST	ALPHA 255 COMPLANARE	2	30	30		E25	E25	0386031	0387031	/	/	/	/	/	038013[3/8]	038513[3]
	ALPHA 370 TT COMPLANARE	2	30	45		E25	E25	0386031	0387031	/	/	/	/	/	038013[3]	038513[3]
	ALPHA 445 FINESTRA	2	28	28		E25	E25	0386031	0387031	/	/	/	/	/	038321	038521
	ALPHA 445 PORTA 1 ANTA	1	28	28		E30	E30	0386031	0387031	/	/	/	/	/	038321	038521
	ALPHA 445 PORTA 2 ANTE	1	28	28		E30	E30	0386001	0387001	/	/	/	/	/	038323	038523
	ALPHA 658 TT COMPLANARE	2	30	40		E25	E25	0386031	0387031	/	/	/	/	/	038016	038016
	ALPHA BLITZ 2000	1	30	50		E30	E30	0386031	0387031	/	/	/	/	/	038013[3/8]	038513[3]
	ALPHA GLOBO 45	2	28	28		E25	E25	0386031	0387031	/	/	/	/	/	038321	038521
	ALPHA GLOBO 55	2	30	30		E25	E25	0386031	0387031	/	/	/	/	/	038013	038513
	GOLD 400 COMPLANARE	2	30	35		E30	E30	0386011	0387011	038031[5/9]	038021[9]	/	/	038074[5]	038319	038519
	GOLD 400 SORMONTO	3	30	35		E35	E35	0386011	0387011	038031[5/9]	038021[9]	/	/	038074[5]	038319	038519
	GOLD 500 COMPLANARE	2	30	45		E30	E30	0386011	0387011	038031[5/9]	038021[9]	/	/	038074[5]	038319	038519
	GOLD 500 SORMONTO	3	30	45		E35	E35	0386011	0387011	038031[5/9]	038021[9]	/	/	038074[5]	038319	038519
	GOLD 600 COMPLANARE	2	30	55		E30	E30	0386011	0387011	038031[5/9]	038021[9]	/	/	038074[5]	038319	038519
	GOLD 600 SORMONTO	3	30	55		E35	E35	0386011	0387011	038031[5/9]	038021[9]	/	/	038074[5]	038319	038519
METRA	NC 45 INTERNATIONAL FINESTRA	2	30	40		E30	E30	0386011	0387011	038031[5/9]	038021[9]	/	/	038074[5]	038319	038519
	NC 45 INTERNATIONAL PORTA	1	28	28	E25	E25	0386001	0387001	/	/	038072	038070	/	038011[1/7]	038511[7]	
	NC 45 SUPERTHERMIC FINESTRA	2	30	40		E25	E25	0386011	0387011	038031[5/9]	038021[9]	/	/	038074[5]	038319	038519
	NC 45 SUPERTHERMIC PORTA	1	28	28		E25	E25	0386001	0387001	/	/	/	/	/	038011[1]	038511
	NC 55 INTERNATIONAL FINESTRA	2	30	50		E25	E25	0386011	0387011	038031[5/9]	038021[9]	/	/	038074[5]	038319	038519
	NC 55 INTERNATIONAL PORTA	1	30	40	E25	E25	0386001	0387001	/	/	038072	038070	/	038011[1]	038511	
	NC 68 SUPERTHERMIC FINESTRA	2	30	55		E25	E25	0386011	0387011	038031[5/9]	038021[9]	/	/	038074[5]	038319	038519
	NC 68 SUPERTHERMIC PORTA	1	30	45	E30	E25	0386001	0387001	/	/	038072	038070	/	038011[1]	038511	
	NUOVO NC 40 COMPLANARE	2	28	28		E25	E25	0386031	0387031	/	/	/	/	/	038321[8/10]	038521[10]
	NUOVO NC 40 SORMONTO 1 ANTA	2	28	28		E25	E25	0386011	0387011	/	/	/	/	/	038320	038520
	NUOVO NC 40 SORMONTO 2 ANTE	2	28	28		E25	E25	0386031	0387031	/	/	/	/	/	038321[8]	038521
	NUOVO NC 40 SORM. 2 ANTE CON RIPORTO	2	28	28		E25	E25	0386011	0387011	/	/	/	/	/	/	/
	NUOVO NC 50 COMPLANARE	2	28	28		E25	E25	0386031	0387031	/	/	/	/	/	038321[8/10]	038521
	NUOVO NC 50 PORTA	1	28	28	E30	E25	E25	0386001	0387001	/	/	038072	038070	/	038011[8]	038511
	NUOVO NC 50 SORMONTO 1 ANTA	2	28	28		E25	E25	0386021	0387021	/	/	/	/	/	038323	038523
	NUOVO NC 50 SORMONTO 2 ANTE	2	28	28		E25	E25	0386021	0387021	/	/	/	/	/	038323	038523
	SUPERBLINDO	1	30	60	E35	E35	0386001	0387001	/	/	038072	038070	/	038011[1]	038511	
MORELLI	MA 8300	2	30	40		E35	E35	0386011	0387011	038031[5/9]	038021[9]	/	/	038074[5]	038319	038519
NEW TEC	NEW TEC 50 PORTA COMPLANARE	1	28	33	E25	E25	0386001	0387001	/	/	/	/	/	038321	038521	
	NEW TEC 50 PORTA SORMONTO	2	28	33		E30	E30	0386021	0387021	/	/	/	/	/	038012	038512
	NEW TEC 52 TT PORTA COMPLANARE	1	28	33	E25	E25	0386001	0387001	/	/	038073	038071	/	038321	038521	
	NEW TEC 52 TT PORTA SORMONTO	2	28	33		E30	E30	0386021	0387021	/	/	/	/	/	038012	038512
	NEW TEC 60 TT PORTA SORMONTO	2	30	40		E30	E30	0386021	0387021	/	/	/	/	/	038012	038512
	NEW TEC 68 TT PORTA COMPLANARE	1	30	50	E30	E25	0386001	0387001	/	/	038073	038071	/	038321	038521	

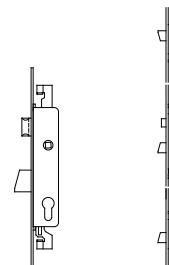

**Mortice locks  
center distance 85 mm**

FRAME MANUFACTURER	PROFILE	FRAME (*)	CYLINDER		FRONT PLATE USABLE BACKSET			STRIKING PLATES									
			C	D	24X7 24X6	24X3	22X3	ADJUSTABLE		STEEL		MULTIPOINT		NYLON			
SERIES								DEADBOLT LATCHBOLT/ROLLER AND ELECTRIC	DEADBOLT AND DEVIATORS ONLY	DEADBOLT LATCHBOLT/ROLLER AND ELECTRIC	DEADBOLT AND DEVIATORS ONLY	WITHOUT TIPS	WITH TIPS	FLAT	DEADBOLT LATCHBOLT/ROLLER AND ELECTRIC	DEADBOLT ONLY HOOK AND DEVIATORS ONLY	
	NEW TEC 68 TT PORTA SORMONTO	2	30	50		E30	E30	0386002	0387002	/	/	/	/	/	038012	038512	
OCMA	FC 47 FINESTRA	2	28	33		E30	E30	0386011	0387011	038031[5,9]	038021[9]	/	/	038074[5]	038319	038519	
	FC 55 FINESTRA	3	30	35		E35	E35	0386011	0387011	038031[5,9]	038021[9]	/	/	038074[5]	038319	038519	
	FC 60 TT FINESTRA	2	30	45		E30	E30	0386011	0387011	038031[5,9]	038021[9]	/	/	038074[5]	038319	038519	
	FC 60 TT PORTA	1	30	45			E35	/	/	/	/	/	/	/	038321[1,8]	038521	
	SV 47 PORTA 1 ANTA	1	28	33	E30		E30	0386001	0387001	/	/	038073	038071	/	038011[1,8]	038511	
	SV 47 PORTA 2 ANTE	1	28	28	E30		E30	0386001	0387001	/	/	/	/	/	038011[1,8]	038511	
	SV 62 PORTA 1 ANTA	1	30	45	E30		E30	0386001	0387001	/	/	038073	038071	/	038011[1,8]	038511	
	SV 62 PORTA 2 ANTE	1	30	45	E30		E30	0386001	0387001	/	/	/	/	/	038011[1,8]	038511	
	SV 62 TT PORTA 1 ANTA	1	30	45	E30		E30	0386001	0387001	/	/	038073	038071	/	038011[1,8]	038511	
	SV 62 TT PORTA 2 ANTE	1	30	45	E30		E30	0386001	0387001	/	/	038073	038071	/	038011[1,8]	038511	
PASSERINI	EKIP 40 COMPLANARE 1 ANTA	2	28	28		E25	E25	0386031	0387031	/	/	/	/	/	038321[8]	038521	
	EKIP 40 COMPLANARE 2 ANTE	2	28	28			E25	0386031	0387031	/	/	/	/	/	038321[8]	038521	
	EKIP 40 EVOLUZIONE 1 ANTA	2	28	28		E25	E25	0386011	0387011	/	/	/	/	/	038320	038520	
	EKIP 40 EVOLUZIONE 2 ANTE	2	28	28		E25	E25	0386011	0387011	038031[5,9]	038021[9]	/	/	038074[5]	038319	038519	
	EKIP 40 SORMONTO 1 ANTA	2	28	28		E25	E25	0386011	0387011	/	/	/	/	/	038320	038520	
	EKIP 40 SORMONTO 2 ANTE	2	28	28		E25	E25	0386011	0387011	038031[5,9]	038021[9]	/	/	038074[5]	038319[8]	038519	
	EKIP 50 COMPLANARE 1 ANTA	2	28	33		E35	E35	0386031	0387031	/	/	/	/	/	/	/	
	EKIP 50 COMPLANARE 2 ANTE	2	28	33			E35	0386031[11]	0387031	/	/	/	/	/	/	/	
	EKIP 50 SORMONTO 1 ANTA	2	28	33		E35	E35	0386021	0387021	/	/	/	/	/	038323	038523	
	EKIP 50 SORMONTO 2 ANTE	2	28	33		E25	E25	0386021	0387021	038031[5,9]	038021[9]	/	/	038074[5]	038319[8]	038519	
	EKIP BLINDO	1	45	45		E35	E35	0386001	0387001	/	/	/	/	/	/	/	
	EKIP MAASTRICHT 53 FINESTRA	2	30	40		E30	E30	0386011	0387011	038031[5,9]	038021[9]	/	/	038074[5]	038319	038519	
	EKIP MAASTRICHT 53 PORTA 1 ANTA	1	30	40	E30		E25	0386001	0387001	/	/	038072	038070	/	038011	038511	
	EKIP MAASTRICHT 53 PORTA 2 ANTE	1	30	35			E30	0386001[1]	0387001	/	/	/	/	/	038011[1]	038511	
	EKIP MAASTRICHT TH 60 FINESTRA	2	30	45		E30	E30	0386011	0387011	038031[5,9]	038021[9]	/	/	038074[5]	038319	038519	
	EKIP MAASTRICHT TH 60 PORTA 1 ANTA	1	30	45	E30		E25	0386001	0387001	/	/	038072	038070	/	038011	038511	
	EKIP MAASTRICHT TH 60 PORTA 2 ANTE	1	30	40			E30	0386001[1]	0387001	/	/	/	/	/	038011[1]	038511	
	EKIP MAASTRICHT TH 68 FINESTRA	2	30	55		E30	E30	0386011	0387011	038031[5,9]	038021[9]	/	/	038074[5]	038319	038519	
	EKIP MAASTRICHT TH 68 PORTA 1 ANTA	1	30	55	E30		E25	0386001	0387001	/	/	038072	038070	/	038011	038511	
	EKIP MAASTRICHT TH 68 PORTA 2 ANTE	1	30	50			E30	0386001[1]	0387001	/	/	/	/	/	038011[1]	038511	
	EKIP THERMO 53 FINESTRA 1 ANTA	2	30	40		E25	E25	0386031	0387031	/	/	/	/	/	/	/	
	EKIP THERMO 53 FINESTRA 2 ANTE	2	30	40		E25	E25	0386031	0387031	/	/	/	/	/	038321[8]	038521	
EKIP THERMO 53 PORTA	1	30	40	E30		E25	0386001	0387001	/	/	038072	038070	/	038011[6]	038511		
PROFILATI	"PE "EKU 53"" FINESTRA"	2	30	40		E30	E30	0386011	0387011	038031[5,9]	038021[9]	/	/	038074[5]	038319	038519	
	"PE "EKU 53"" PORTA"	1	30	30	E25		E25	0386001	0387001	/	/	038073	038071	/	038321	038521	
	"PE "EKU 64 TT"" FINESTRA"	2	30	50		E30	E30	0386011	0387011	038031[5,9]	038021[9]	/	/	038074[5]	038319	038519	
	"PE "EKU 64 TT"" PORTA"	1	30	40	E25		E25	0386001	0387001	/	/	038073	038071	/	038321	038521	
	"PE "EKU 72 TT"" FINESTRA"	2	30	60		E30	E30	0386011	0387011	038031[5,9]	038021[9]	/	/	038074[5]	038319	038519	
	"PE "EKU 72 TT"" PORTA"	1	30	50	E25		E25	0386001	0387001	/	/	038073	038071	/	038321	038521	
	SISTEMA PE 1 40 COMP./EST. 1 ANTA	2	28	28		E30	E30	0386011	0387011	/	/	/	/	/	038320	038520	
	SISTEMA PE 1 40 COMP./EST. 2 ANTE	2	28	28		E30	E30	0386031	0387031	/	/	/	/	/	038321	038521	
	SISTEMA PE 1 40 SORMONTO 1 ANTA	2	28	28		E30	E30	0386011	0387011	/	/	/	/	/	038320	038520	
	SISTEMA PE 1 40 SORMONTO 2 ANTE	2	28	28		E30	E30	0386031	0387031	/	/	/	/	/	038321	038521	
	SISTEMA PE 1 50 COMP./EST. 1 ANTA	2	30	40		E30	E30	0386011	0387011	/	/	/	/	/	038320	038520	
	SISTEMA PE 1 50 COMP./EST. 2 ANTE	2	30	40		E30	E30	0386031	0387031	/	/	/	/	/	038321	038521	
	SISTEMA PE 1 50 SORMONTO 1 ANTA	2	30	35		E30	E30	0386011	0387011	/	/	/	/	/	038320	038520	
	SISTEMA PE 1 50 SORMONTO 2 ANTE	2	30	35		E30	E30	0386031	0387031	/	/	/	/	/	038321	038521	
	SCHÜCO	ROYAL 78 ST BLINDATO	1	40	40	E30		E25	0386001	0387001	/	/	038072	038070	/	038011[1]	038511

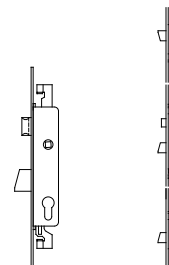

**Mortice locks  
center distance 85 mm**

PROFILE		CYLINDER		FRONT PLATE USABLE BACKSET			STRIKING PLATES									
FRAME MANUFACTURER	SERIES	FRAME (*)	C	D	24X7 24X6	24X3	22X3	ADJUSTABLE		STEEL		MULTIPOINT			NYLON	
								DEADBOLT LATCHBOLT/ROLLER AND ELECTRIC	DEADBOLT AND DEVIATORS ONLY	DEADBOLT LATCHBOLT/ROLLER AND ELECTRIC	DEADBOLT AND DEVIATORS ONLY	WITHOUT TIPS	WITH TIPS	FLAT	DEADBOLT LATCHBOLT/ROLLER AND ELECTRIC	DEADBOLT ONLY HOOK AND DEVIATORS ONLY
	ROYAL S 50 N	1	30	30	E35		E30	0386001	0387001	038030[5]	038020	/	/	/	/	/
	ROYAL S 55 TT	1	30	40	E35		E30	0386001	0387001	038030[5]	038020	/	/	/	/	/
	ROYAL S 65 TT	1	30	45	E35		E35	0386001	0387001	038030[5]	038020	/	/	/	/	/
WICONA	L60A	1	30	45			E35	0386001	0387001	/	/	/	/	/	038011[1]	038511
	L70A	1	30	50			E35	0386001	0387001	/	/	/	/	/	038011[1]	038511

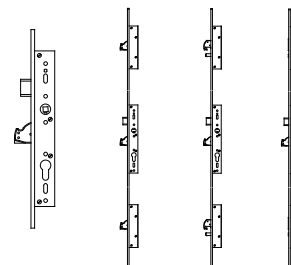

**Mortice locks  
center distance 92 mm**

PROFILE		CYLINDER			FRONT PLATE USABLE BACKSET				MODULAR STRIKING PLATES						
FRAME MANUFACTURER	SERIES	FRAME (*)	C		ESCUTCHEON	24X6	24X7	24X3	22X3	RIGHT-HAND LOCK	LEFT-HAND LOCK	DEADBOLT DEVIATORS L=180	HOOK DEVIATORS L=180	DEADBOLT DEVIATORS L=180	HOOK DEVIATORS L=180
			C	D											
ALCAN	ABITHAL CRISTAL	2	30	50	NO	/	/	E35	E35	033173	033174	033181	033182	033177	033178
	ABITHAL KEEPER PORTA 53-60	1	30	40	SI	E30	E30	E30[12]	E30	033162	033163	033170	033171	033166	033167
	ABITHAL KEEPER PORTA 61-68	1	30	40	SI	E30	E30	E30[12]	E30	033162	033163	033170	033171	033166	033167
	ABITHAL KEEPER PORTA C.E.	2	30	40	NO	/	/	E30	E30	033173	033174	033181	033182	033177	033178
	ABITHAL PORTA	1	28	28	NO	/	/	E25	E25	033162	033163	033170	033171	033166	033167
	WINNER FINESTRA	2	28	40	NO	/	/	E25	E25	033173	033174	033181	033182	033177	033178
	WINNER PORTA	1	28	28	NO	/	/	E25	E25	033162	033163	033170	033171	033166	033167
ALCOA	FB 12 BLINDATO	1	28	33	SI	E35	E35	E30[12]	E30	033162	033163	033170	033171	033166	033167
	FB 12 GA / EUROPA GA	2	30	40	NO	/	/	E30	E30	033173	033174	033181	033182	033177	033178
	FB 12 T.T.	1	30	45	NO	/	/	E30	E30	033173	033174	033181	033182	033177	033178
	FORMULA F40 PORTA	1	28	33	SI	E30	E30	E30[12]	E30	033162	033163	033170	033171	033166	033167
	FORMULA F40 TT PORTA	1	28	33	SI	E25	E25	E25[12]	E25	033162	033163	033170	033171	033166	033167
	FORMULA F50 PORTA	1	30	45	SI	E30	E30	E30[12]	E30	033162	033163	033170	033171	033166	033167
	FORMULA F50 TT PORTA	1	30	45	SI	E25	E25	E25[12]	E25	033162	033163	033170	033171	033166	033167
	FORMULA F60 TT PORTA	1	30	50	SI	E25	E25	E25[12]	E25	033162	033163	033170	033171	033166	033167
	PLANA 1 ANTA	2	28	33	NO	/	/	E25[12]	E25	033162	033163	033170	033171	033166	033167
	PLANA 2 ANTE	2	28	33	NO	E25	E25	E25[12]	E25	033162	033163	033170	033171	033166	033167
	R 35 REVERSIBILE	2	28	28	NO	/	/	E25[12]	E25	033173	033174	033181	033182	033177	033178
R 35 SORMONTO	2	28	33	NO	/	/	E30[12]	E30	033173	033174	033181	033182	033177	033178	
ALL.CO FINAL ITES	ALL.CO 5 PORTA	1	28	33	SI	E30	E30	E25[12]	E25	033162	033163	033170	033171	033166	033167
	ALL.CO 5 TT PORTA	1	30	45	SI	E30	E30	E25[12]	E25	033162	033163	033170	033171	033166	033167
	EXPORT 40 FINESTRA	2	30	45	NO	/	/	E30	E30	033173	033174	033181	033182	033177	033178
	EXPORT 45 TT FINESTRA	2	30	40	NO	/	/	E25	E25	033173	033174	033181	033182	033177	033178
	EXPORT 50 FINESTRA	2	30	45	NO	/	/	E30	E30	033173	033174	033181	033182	033177	033178
	EXPORT 50 PORTA	1	30	35	SI	E30	E30	E25[12]	E25	033162	033163	033170	033171	033166	033167
	EXPORT 50 TT FINESTRA	2	30	55	NO	/	/	E30	E30	033173	033174	033181	033182	033177	033178
	EXPORT 50 TT PORTA	1	30	50	SI	/	/	E25[12]	E25	033162	033163	033170	033171	033166	033167
	FINAL 40 FINESTRA	2	28	33	NO	/	/	E30	E30	033173	033174	033181	033182	033177	033178
	SICURBLIN 65	1	40	40	SI	E30	E30	E25[12]	E25	033162	033163	033170	033171	033166	033167
SICURBLIN C.E.	1	30	60	NO	/	/	E30	E30	033173	033174	033181	033182	033177	033178	
ALNOR	MONTREAL PORTA	1	28	28	SI	E25	E25	E25[12]	E25	033162	033163	033170	033171	033166	033167
ALUSUISSE	ALSEC 2000 FINESTRA 59	2	30	55	NO	/	/	E30	E30	033173	033174	033181	033182	033177	033178
	ALSEC 2000 FINESTRA 69	2	30	65	NO	/	/	E30	E30	033173	033174	033181	033182	033177	033178
	ALSEC 2000 PORTA 59	1	30	45	SI	E30	E30	E30[12]	E30	033162	033163	033170	033171	033166	033167
	ALSEC 2000 PORTA 69	1	30	45	SI	E30	E30	E30[12]	E30	033162	033163	033170	033171	033166	033167
ALU-K	ALUBLINDO	1	45	45	SI	E30	E30	E25[12]	E25	033162	033163	033170	033171	033166	033167
	N 45 PORTA	1	28	28	SI	E30	E30	E25[12]	E25	033162	033163	033170	033171	033166	033167
	N 53 PORTA	1	30	35	SI	E35	E35	E30[12]	E30	033162	033163	033170	033171	033166	033167
	N 55 TT PORTA	1	30	40	SI	E35	E35	E30[12]	E30	033162	033163	033170	033171	033166	033167
	N 62 TT PORTA	1	30	45	SI	E35	E35	E30[12]	E30	033162	033163	033170	033171	033166	033167
ALU-MEC	SYNTHESIS 45 FINESTRA	2	28	33	NO	/	/	E35	E35	033173	033174	033181	033182	033177	033178
	SYNTHESIS 57 FINESTRA	2	30	45	NO	/	/	E35	E35	033173	033174	033181	033182	033177	033178
	SYNTHESIS 57 PORTA	2	35	35	SI	E35	E35	E30[12]	E30	033162	033163	033170	033171	033166	033167
	SYNTHESIS 60 TT FINESTRA	2	30	50	NO	/	/	E35	E35	033173	033174	033181	033182	033177	033178
	SYNTHESIS 60 TT PORTA	2	30	45	SI	E40	E40	E30	E30	033162	033163	033170	033171	033166	033167

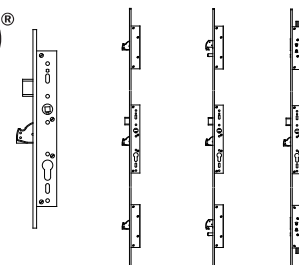

**Mortice locks  
center distance 92 mm**

PROFILE		CYLINDER				FRONT PLATE USABLE BACKSET				MODULAR STRIKING PLATES					
FRAME MANUFACTURER	SERIES	FRAME (*)	C	D	ESCUTCHEON	24X6	24X7	24X3	22X3	RIGHT-HAND LOCK	LEFT-HAND LOCK	DEADBOLT DEVIATORS L=180	HOOK DEVIATORS L=180	DEADBOLT DEVIATORS L=180	HOOK DEVIATORS L=180
BODEGA	BGA 50	2	30	40	NO	/	/	E25	E25	033173	033174	033181	033182	033177	033178
	EXTRABLIND 70	2	40	50	SI	E40	E40	/	/	033162	033163	033170	033171	033166	033167
	NEW BT 60	2	30	50	NO	/	/	E30	E30	033173	033174	033181	033182	033177	033178
DOMAL	DOMAL BREAK 52 FINESTRA	2	30	40	NO	/	/	E30	E30	033173	033174	033181	033182	033177	033178
	DOMAL BREAK 52 PORTA	1	30	35	SI	E30	E30	E25[12]	E25	033162	033163	033170	033171	033166	033167
	DOMAL BREAK 70 FINESTRA	2	30	55	NO	/	/	E30	E30	033173	033174	033181	033182	033177	033178
	DOMAL BREAK 70 PORTA	1	30	50	SI	E30	E30	E25[12]	E25	033162	033163	033170	033171	033166	033167
	DOMAL SECURITY PORTA	1	45	45	SI	E40	E40	E35[12]	E35	033162	033163	033170	033171	033166	033167
	DOMAL SHOPS PORTA	1	30	45	SI	E30	E30	E25[12]	E25	033162	033163	033170	033171	033166	033167
	DOMAL STOPPER PG FINESTRA	2	30	40	NO	/	/	E30	E30	033173	033174	033181	033182	033177	033178
	DOMAL STOPPER PG PORTA	1	28	33	SI	E30	E30	E25[12]	E25	033162	033163	033170	033171	033166	033167
	EQUIPE	SISTEMA 8000 G.A. FINESTRA 1 ANTA	2	28	33	NO	/	/	E40	E40	033173	033174	033181	033182	033177
SISTEMA 8000 G.A. FINESTRA 2 ANTE		2	28	33	NO	/	/	E40	E40	033173	033174	033181	033182	033177	033178
SISTEMA 8000 TT FINESTRA 1 ANTA		2	30	55	NO	/	/	E40	E40	033173	033174	033181	033182	033177	033178
SISTEMA 8000 TT FINESTRA 2 ANTE		2	30	55	NO	/	/	E40	E40	033173	033174	033181	033182	033177	033178
ESA	BLINDAL 60 PORTA 1 ANTA	2	35	35	SI	E35[14]	/	E35[12]	E35	033162	033163	033170	033171	033166	033167
	BLINDAL 60 PORTA 2 ANTE	2	35	35	SI	E35[14]	/	E35[12]	E35	033162	033163	033170	033171	033166	033167
	BLINDAL 70 PORTA 1 ANTA	1	35	50	SI	E35	E35	E35	E35	033162	033163	033170	033171	033166	033167
	BLINDAL 70 PORTA 2 ANTE	1	35	50	SI	E35	E35	E35	E35	033162	033163	033170	033171	033166	033167
	ISOLA PORTA	1	30	45	SI	/	/	E30	E30	033173	033174	033181	033182	033177	033178
ESEDRA	GA 53 PORTA	2	30	40	NO	/	/	E30/E35	E30/E35	033173	033174	033181	033182	033177	033178
	TT 63 PORTA	2	30	50	NO	/	/	E30/E35	E30/E35	033173	033174	033181	033182	033177	033178
	TT 75 PORTA	2	30	60	NO	/	/	E30/E35	E30/E35	033173	033174	033181	033182	033177	033178
FRESIA	GLOBAL 48 PORTA	1	30	30	SI	E30	E30	E25	E25	033162	033163	033170	033171	033166	033167
INDINVESTALPHA	445 PORTA 2 ANTE	1	28	28	SI	E35	E35	E30	E30	033162	033163	033170	033171	033166	033167
	GOLD 400 COMPLANARE	2	28	33	NO	/	/	E30	E30	033173	033174	033181	033182	033177	033178
	GOLD 400 SORMONTO	3	28	33	NO	/	/	E30	E30	033173	033174	033181	033182	033177	033178
	GOLD 500 COMPLANARE	2	30	45	NO	/	/	E30	E30	033173	033174	033181	033182	033177	033178
	GOLD 500 SORMONTO	3	30	45	NO	/	/	E30	E30	033173	033174	033181	033182	033177	033178
	GOLD 600 COMPLANARE	2	30	55	NO	/	/	E30	E30	033173	033174	033181	033182	033177	033178
	GOLD 600 SORMONTO	3	30	55	NO	/	/	E30	E30	033173	033174	033181	033182	033177	033178
METRA	NC 45 INTERNATIONAL FINESTRA	2	30	40	NO	/	/	E30	E30	033173	033174	033181	033182	033177	033178
	NC 45 INTERNATIONAL PORTA	1	28	33	SI	E25	E25	E25[12]	E25	033162	033163	033170	033171	033166	033167
	NC 45 SUPERTHERMIC FINESTRA	2	30	40	NO	/	/	E25	E25	033173	033174	033181	033182	033177	033178
	NC 45 SUPERTHERMIC PORTA	1	28	33	SI	E30	E30	E25[12]	E25	033162	033163	033170	033171	033166	033167
	NC 55 INTERNATIONAL FINESTRA	2	30	50	NO	/	/	E25	E25	033173	033174	033181	033182	033177	033178
	NC 55 INTERNATIONAL PORTA	1	30	40	SI	E30	E30	E25[12]	E25	033162	033163	033170	033171	033166	033167
	NC 68 SUPERTHERMIC FINESTRA	2	30	55	NO	/	/	E25	E25	033173	033174	033181	033182	033177	033178
	NC 68 SUPERTHERMIC PORTA	1	30	45	SI	E30	E30	E25[12]	E25	033162	033163	033170	033171	033166	033167
	NUOVO NC 50 PORTA	1	30	30	SI	E30	E30	E25	E25	033162	033163	033170	033171	033166	033167
	SUPERBLINDO	1	30	60	SI	E35	E35	E30[12]	E30	033162	033163	033170	033171	033166	033167
	MORELLI	MA 8300	1	30	40	NO	/	/	E30	E30	033173	033174	033181	033182	033177
NEW TEC	NEW TEC 50 PORTA COMPLANARE	1	30	35	SI	E25	E25	E25[12]	E25	033162	033163	033170	033171	033166	033167

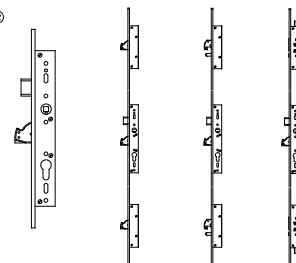

**Mortice locks  
center distance 92 mm**

PROFILE		CYLINDER			FRONT PLATE USABLE BACKSET				MODULAR STRIKING PLATES						
FRAME MANUFACTURER	SERIES	FRAME (*)	C	D	ESCUTCHEON	24X6	24X7	24X3	22X3	RIGHT-HAND LOCK	LEFT-HAND LOCK	DEADBOLT DEVIATORS L=180	HOOK DEVIATORS L=180	DEADBOLT DEVIATORS L=180	HOOK DEVIATORS L=180
	NEW TEC 52 TT PORTA COMPLANARE	1	30	35	SI	E25	E25	E25[12]	E25	033162	033163	033170	033171	033166	033167
	NEW TEC 68 TT PORTA COMPLANARE	1	30	55	SI	E30	E30	E25[12]	E25	033162	033163	033170	033171	033166	033167
OCMA	FC 47 FINESTRA	2	28	33	NO	/	/	E30	E30	033173	033174	033181	033182	033177	033178
	FC 55 FINESTRA	3	30	40	NO	/	/	E35	E35	033173	033174	033181	033182	033177	033178
	FC 60 TT FINESTRA	2	30	45	NO	/	/	E30	E30	033173	033174	033181	033182	033177	033178
	FC 60 TT PORTA	1	30	45	SI	E35[13]	E35[13]	/	/	033162	033163	033170	033171	033166	033167
	SV 47 PORTA 1 ANTA	1	28	33	SI	E35	E35	E30[12]	E30	033162	033163	033170	033171	033166	033167
	SV 47 PORTA 2 ANTE	1	28	33	SI	E35	E35	E30[12]	E30	033162	033163	033170	033171	033166	033167
	SV 62 PORTA 1 ANTA	1	30	45	SI	E30	E30	E30[12]	E30	033162	033163	033170	033171	033166	033167
	SV 62 PORTA 2 ANTE	1	30	45	SI	E30	E30	E30[12]	E30	033162	033163	033170	033171	033166	033167
	SV 62 TT PORTA 1 ANTA	1	30	45	SI	E30	E30	E30[12]	E30	033162	033163	033170	033171	033166	033167
	SV 62 TT PORTA 2 ANTE	1	30	45	SI	E30	E30	E30[12]	E30	033162	033163	033170	033171	033166	033167
PASSERINI	EKIP 40 EVOLUZIONE 2 ANTE	2	28	28	NO	/	/	E25	E25	033173	033174	033181	033182	033177	033178
	EKIP 40 SORMONTO 2 ANTE	2	28	28	NO	/	/	E25	E25	033173	033174	033181	033182	033177	033178
	EKIP BLINDO	1	45	45	SI	E40	E40	E35	E35	033162	033163	033170	033171	033166	033167
	EKIP MAASTRICHT 53 FINESTRA	2	30	40	NO	/	/	E30	E30	033173	033174	033181	033182	033177	033178
	EKIP MAASTRICHT 53 PORTA 1 ANTA	1	30	40	SI	E30	E30	E25[12]	E25	033162	033163	033170	033171	033166	033167
	EKIP MAASTRICHT 53 PORTA 2 ANTE	1	30	35	SI	E30	E30	E25[12]	E25	033162	033163	033170	033171	033166	033167
	EKIP MAASTRICHT TH 60 FINESTRA	2	30	45	NO	/	/	E30	E30	033173	033174	033181	033182	033177	033178
	EKIP MAASTRICHT TH 60 PORTA 1 ANTA	1	30	45	SI	E30	E30	E25[12]	E25	033162	033163	033170	033171	033166	033167
	EKIP MAASTRICHT TH 60 PORTA 2 ANTE	1	30	40	SI	E30	E30	E25[12]	E25	033162	033163	033170	033171	033166	033167
	EKIP MAASTRICHT TH 68 FINESTRA	2	30	55	NO	/	/	E30	E30	033173	033174	033181	033182	033177	033178
	EKIP MAASTRICHT TH 68 PORTA 1 ANTA	1	30	55	SI	E30	E30	E25[12]	E25	033162	033163	033170	033171	033166	033167
	EKIP MAASTRICHT TH 68 PORTA 2 ANTE	1	30	50	SI	E30	E30	E25[12]	E25	033162	033163	033170	033171	033166	033167
	EKIP THERMO 53 PORTA	1	30	40	SI	E30	E30	E25[12]	E25	033162	033163	033170	033171	033166	033167
	PROFILATI	"PE ""EKU 53"" FINESTRA"	2	30	40	NO	/	/	E30	E30	033173	033174	033181	033182	033177
"PE ""EKU 53"" PORTA"		1	30	30	SI	E25	E25	E25[12]	E25	033162	033163	033170	033171	033166	033167
"PE ""EKU 64 TT"" FINESTRA"		2	30	50	NO	/	/	E30	E30	033173	033174	033181	033182	033177	033178
"PE ""EKU 64 TT"" PORTA"		1	30	40	SI	E25	E25	E25[12]	E25	033162	033163	033170	033171	033166	033167
"PE ""EKU 72 TT"" FINESTRA"		2	30	60	NO	/	/	E30	E30	033173	033174	033181	033182	033177	033178
"PE ""EKU 72 TT"" PORTA"		1	30	50	SI	E25	E25	E25[12]	E25	033162	033163	033170	033171	033166	033167
SISTEMA 1 PE 40 COMP./EST. 2 ANTE		2	28	33	NO	/	/	E25	E25	033162	033163	033170	033171	033166	033167
SISTEMA 1 PE 40 SORMONTO 2 ANTE		2	28	28	NO	/	/	E25	E25	033162	033163	033170	033171	033166	033167
SCHÜCO	ROYAL 78 ST BLINDATO	1	40	40	SI	E30	E30	E25[12]	E25	033162	033163	033170	033171	033166	033167
	ROYAL S 50 N	1	30	30	SI	E35	/	E30[12]	E30	033162	033163	033170	033171	033166	033167
	ROYAL S 55 TT	1	30	40	SI	E35	/	E30[12]	E30	033162	033163	033170	033171	033166	033167
	ROYAL S 65 TT	1	30	50	SI	E35	/	E30[12]	E30	033162	033163	033170	033171	033166	033167
WICONA	L60-A	1	30	45	SI	E35	E35	E30[12]	E30	033162	033163	033170	033171	033166	033167
	L70-A	1	30	50	SI	E40	E40	E35[12]	E35	033162	033163	033170	033171	033166	033167

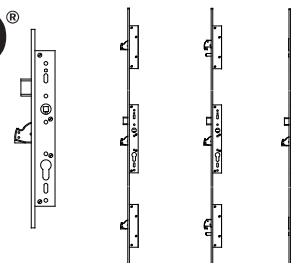

**Mortice locks  
center distance 92 mm**

PROFILE		CYLINDER			FRONT PLATE USABLE BACKSET				MODULAR STRIKING PLATES						
FRAME MANUFACTURER	SERIES	FRAME (*)				24X6	24X7	24X3	22X3	CHIUSE			ADJUSTABLE		
			C	D	ESCUTCHEON					LOCKS	HOOK DEVIATORS	DEADBOLT DEVIATORS	LOCKS	DEADBOLT DEVIATORS	HOOK DEVIATORS
ALCAN	ABITHAL CRISTAL	2	30	50	NO	/	/	E35	E35	038085	038086	038087	0386011	0387011	038711
	ABITHAL KEEPER PORTA 53-60	1	30	40	SI	E30	E30	E30[12]	E30	038079	038083	038084	0386001	0387001	038710
	ABITHAL KEEPER PORTA 61-68	1	30	40	SI	E30	E30	E30[12]	E30	038079	038083	038084	0386001	0387001	038710
	ABITHAL KEEPER PORTA C.E.	2	30	40	NO	/	/	E30	E30	038085	038086	038087	0386011	0387011	038711
	ABITHAL PORTA	1	28	28	NO	/	/	E25	E25	038079	038083	038084	0386001	0387001	038710
	WINNER FINESTRA	2	28	40	NO	/	/	E25	E25	038085	038086	038087	0386011	0387011	038711
	WINNER PORTA	1	28	28	NO	/	/	E25	E25	038079	038083	038084	0386001	0387001	038710
ALCOA	ALUBLIND	1	30	80	SI	/	/	E35	E35	/	/	/	0386021	0387021	/
	FB 12 BLINDATO	1	28	33	SI	E35	E35	E30[12]	E30	038079	038083	038084	0386001	0387001	038710
	FB 12 GA / EUROPA GA	2	30	40	NO	/	/	E30	E30	038085	038086	038087	0386011	0387011	038711
	FB 12 T.T.	1	30	45	NO	/	/	E30	E30	038085	038086	038087	0386011	0387011	038711
	FORMULA F40 PORTA	1	28	33	SI	E30	E30	E30[12]	E30	038079	038083	038084	0386001	0387001	038710
	FORMULA F40 TT PORTA	1	28	33	SI	E25	E25	E25[12]	E25	038079	038083	038084	0386001	0387001	038710
	FORMULA F50 PORTA	1	30	45	SI	E30	E30	E30[12]	E30	038079	038083	038084	0386001	0387001	038710
	FORMULA F50 TT PORTA	1	30	45	SI	E25	E25	E25[12]	E25	038079	038083	038084	0386001	0387001	038710
	FORMULA F60 TT PORTA	1	30	50	SI	E25	E25	E25[12]	E25	038079	038083	038084	0386001	0387001	038710
	PLANA 1 ANTA	2	28	33	NO	/	/	E25[12]	E25	038079	038083	038084	0386001	0387001	038710
	PLANA 2 ANTE	2	28	33	NO	E25	E25	E25[12]	E25	038079	038083	038084	0386001	0387001	038710
	R 35 REVERSIBILE	2	28	28	NO	/	/	E25[12]	E25	038085	038086	038087	0386011	0387011	038711
	R 35 SORMONTO	2	28	33	NO	/	/	E30[12]	E30	038085	038086	038087	0386011	0387011	038711
	R 40 REVERSIBILE 1 ANTA	2	28	33	NO	/	/	E30	E30	/	/	/	0386021	0387021	/
	R 40 REVERSIBILE 2 ANTE	2	28	33	NO	/	/	E30	E30	/	/	/	0386021	0387021	/
	R 40 SORMONTO 1 ANTA	2	28	28	NO	/	/	E25	E25	/	/	/	0386021	0387021	/
	R 40 SORMONTO 2 ANTE	2	28	28	NO	/	/	E25	E25	/	/	/	0386021	0387021	/
	R 50 SORMONTO 1 ANTA	2	28	28	NO	/	/	E30	E30	/	/	/	0386021	0387021	/
R 50 SORMONTO 2 ANTE	2	28	28	NO	/	/	E30	E30	/	/	/	0386021	0387021	/	
R 50 TT SORMONTO 1 ANTA	2	28	28	NO	/	/	E30	E30	/	/	/	0386021	0387021	/	
R 50 TT SORMONTO 2 ANTE	2	28	28	NO	/	/	E30	E30	/	/	/	0386021	0387021	/	
R 60 TT COMPLANARE	2	30	45	NO	/	/	E30	E30	/	/	/	0386021	0387021	/	
ALL.CO FINAL ITES	ALL.CO 5 COMPLANARE	2	28	28	NO	/	/	E25	E25	038085	038086	038087	0386031	0387031	/
	ALL.CO 5 PORTA	1	28	33	SI	E30	E30	E25[12]	E25	038079	038083	038084	0386001	0387001	038710
	ALL.CO 5 REVERSIBILE	2	28	28	NO	/	/	E25	E25	/	/	/	0386021	0387021	/
	ALL.CO 5 TT PORTA	1	30	45	SI	E30	E30	E25[12]	E25	038079	038083	038084	0386001	0387001	038710
	EXPORT 40 FINESTRA	2	30	45	NO	/	/	E30	E30	038085	038086	038087	0386011	0387011	038711
	EXPORT 45 TT FINESTRA	2	30	40	NO	/	/	E25	E25	038085	038086	038087	0386011	0387011	038711
	EXPORT 50 FINESTRA	2	30	45	NO	/	/	E30	E30	038085	038086	038087	0386011	0387011	038711
	EXPORT 50 PORTA	1	30	35	SI	E30	E30	E25[12]	E25	038079	038083	038084	0386001	0387001	038710
	EXPORT 50 TT FINESTRA	2	30	55	NO	/	/	E30	E30	038085	038086	038087	0386011	0387011	038711
	EXPORT 50 TT PORTA	1	30	50	SI	/	/	E25[12]	E25	038079	038083	038084	0386001	0387001	038710
	FINAL 40 FINESTRA	2	28	33	NO	/	/	E30	E30	038085	038086	038087	0386011	0387011	038711
	ITES P4 COMPLANARE	2	28	28	NO	/	/	E25	E25	038085	038086	038087	0386031	0387031	/
	ITES P4 SORMONTO	2	28	28	NO	/	/	E25	E25	/	/	/	0386021	0387021	/
	SICURBLIN 65	1	40	40	SI	E30	E30	E25[12]	E25	038079	038083	038084	0386001	0387001	038710
SICURBLIN C.E.	1	30	60	NO	/	/	E30	E30	038085	038086	038087	0386011	0387011	038711	
ALNOR	BLINDO BLOCK	1	30	55	NO	/	/	E30	E30	038085	038086	038087	0386031	0387031	/
	MONTREAL G.A.	2	28	28	NO	/	/	E25	E25	038085	038086	038087	0386031	0387031	/
	MONTREAL PORTA	1	28	28	SI	E25	E25	E25[12]	E25	038079	038083	038084	0386001	0387001	038710
ALUSUISSE	ALSEC 2000 FINESTRA 59	2	30	55	NO	/	/	E30	E30	038085	038086	038087	0386011	0387011	038711

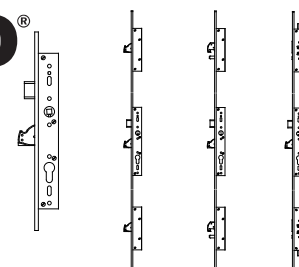

**Mortice locks  
center distance 92 mm**

FRAME MANUFACTURER	PROFILE	CYLINDER 	FRONT PLATE USABLE BACKSET				MODULAR STRIKING PLATES								
			FRAME (*)	C	D	ESCUTCHEON	24X6	24X7	24X3	22X3	LOCKS	HOOK DEVIATORS	DEADBOLT DEVIATORS	LOCKS	HOOK DEVIATORS
	ALSEC 2000 FINESTRA 69	2	30	65	NO	/	/	E30	E30	038085	038086	038087	0386011	0387011	038711
	ALSEC 2000 PORTA 59	1	30	45	SI	E30	E30	E30[12]	E30	038079	038083	038084	0386001	0387001	038710
	ALSEC 2000 PORTA 69	1	30	45	SI	E30	E30	E30[12]	E30	038079	038083	038084	0386001	0387001	038710
ALU-K	ALUBLINDO	1	45	45	SI	E30	E30	E25[12]	E25	038079	038083	038084	0386001	0387001	038710
	N 45 PORTA	1	28	28	SI	E30	E30	E25[12]	E25	038079	038083	038084	0386001	0387001	038710
	N 45 REVERSIBILE	2	28	28	NO	/	/	E25	E25	/	/	/	0386021	0387021	/
	N 53 COMPLANARE	2	30	35	NO	/	/	E25	E25	038085	038086	038087	0386031	0387031	/
	N 53 PORTA	1	30	35	SI	E35	E35	E30[12]	E30	038079	038083	038084	0386001	0387001	038710
	N 55 TT COMPLANARE	2	30	40	NO	/	/	E25	E25	038085	038086	038087	0386031	0387031	/
	N 55 TT PORTA	1	30	40	SI	E35	E35	E30[12]	E30	038079	038083	038084	0386001	0387001	038710
	N 62 TT PORTA	1	30	45	SI	E35	E35	E30[12]	E30	038079	038083	038084	0386001	0387001	038710
ALU-MEC	SYNTHESIS 45 FINESTRA	2	28	33	NO	/	/	E35	E35	038085	038086	038087	0386011	0387011	038711
	SYNTHESIS 57 FINESTRA	2	30	45	NO	/	/	E35	E35	038085	038086	038087	0386011	0387011	038711
	SYNTHESIS 57 PORTA	2	35	35	SI	E35	E35	E30[12]	E30	038079	038083	038084	0386001	0387001	038710
	SYNTHESIS 60 TT FINESTRA	2	30	50	NO	/	/	E35	E35	038085	038086	038087	0386011	0387011	038711
	SYNTHESIS 60 TT PORTA	2	30	45	SI	E40	E40	E30	E30	038079	038083	038084	0386001	0387001	038710
BODEGA	BGA 50	2	30	40	NO	/	/	E25	E25	038085	038086	038087	0386011	0387011	038711
	EXTRABLIND 70	2	40	50	SI	E40	E40	/	/	038079	038083	038084	0386001	0387001	038710
	NEW BT 60	2	30	50	NO	/	/	E30	E30	038085	038086	038087	0386011	0387011	038711
DOMAL	DOMAL BREAK 52 FINESTRA	2	30	40	NO	/	/	E30	E30	038085	038086	038087	0386011	0387011	038711
	DOMAL BREAK 52 PORTA	1	30	35	SI	E30	E30	E25[12]	E25	038079	038083	038084	0386001	0387001	038710
	DOMAL BREAK 70 FINESTRA	2	30	55	NO	/	/	E30	E30	038085	038086	038087	0386011	0387011	038711
	DOMAL BREAK 70 PORTA	1	30	50	SI	E30	E30	E25[12]	E25	038079	038083	038084	0386001	0387001	038710
	DOMAL SECURITY PORTA	1	45	45	SI	E40	E40	E35[12]	E35	038079	038083	038084	0386001	0387001	038710
	DOMAL SHOPS PORTA	1	30	45	SI	E30	E30	E25[12]	E25	038079	038083	038084	0386001	0387001	038710
	DOMAL STOPPER PG FINESTRA	2	30	40	NO	/	/	E30	E30	038085	038086	038087	0386011	0387011	038711
	DOMAL STOPPER PG PORTA	1	28	33	SI	E30	E30	E25[12]	E25	038079	038083	038084	0386001	0387001	038710
EQUIPE	SISTEMA 8000 G.A. FINESTRA 1 ANTA	2	28	33	NO	/	/	E40	E40	038085	038086	038087	0386011	0387011	038711
	SISTEMA 8000 G.A. FINESTRA 2 ANTE	2	28	33	NO	/	/	E40	E40	038085	038086	038087	0386011	0387011	038711
	SISTEMA 8000 TT FINESTRA 1 ANTA	2	30	55	NO	/	/	E40	E40	038085	038086	038087	0386011	0387011	038711
	SISTEMA 8000 TT FINESTRA 2 ANTE	2	30	55	NO	/	/	E40	E40	038085	038086	038087	0386011	0387011	038711
ESA	BLINDAL 60 PORTA 1 ANTA	2	35	35	SI	E35[14]	/	E35[12]	E35	038079	038083	038084	0386001	0387001	038710
	BLINDAL 60 PORTA 2 ANTE	2	35	35	SI	E35[14]	/	E35[12]	E35	038079	038083	038084	0386001	0387001	038710
	BLINDAL 70 PORTA 1 ANTA	1	35	50	SI	E35	E35	E35	E35	038079	038083	038084	0386001	0387001	038710
	BLINDAL 70 PORTA 2 ANTE	1	35	50	SI	E35	E35	E35	E35	038079	038083	038084	0386001	0387001	038710
	GIUNTALL COMPLANARE	2	28	28	NO	/	/	E25	E25	038085	038086	038087	0386031	0387031	/
	GIUNTALL PORTA	1	30	30	NO	/	/	E25	E25	038085	038086	038087	0386021	0387021	/
	ISOLA PORTA	1	30	45	SI	/	/	E30	E30	038085	038086	038087	0386011	0387011	038711
ESEDRA	GA 53 PORTA	2	30	40	NO	/	/	E30/E35	E30/E35	038085	038086	038087	0386011	0387011	038711
	TT 63 PORTA	2	30	50	NO	/	/	E30/E35	E30/E35	038085	038086	038087	0386011	0387011	038711
	TT 75 PORTA	2	30	60	NO	/	/	E30/E35	E30/E35	038085	038086	038087	0386011	0387011	038711
FRESIA	GLOBAL 41 COMPLANARE	2	28	33	NO	/	/	E30	E30	/	/	/	0386021	0387021	/
	GLOBAL 41 SORMONTO	2	28	33	NO	/	/	E30	E30	/	/	/	0386021	0387021	/
	GLOBAL 48 COMPLANARE	2	30	40	NO	/	/	E30	E30	/	/	/	0386021	0387021	/



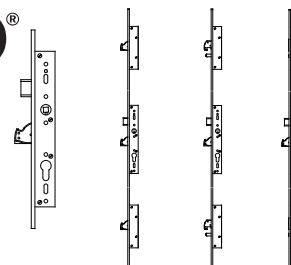

**Mortice locks  
center distance 92 mm**

PROFILE		CYLINDER			FRONT PLATE USABLE BACKSET				MODULAR STRIKING PLATES						
FRAME MANUFACTURER	SERIES	FRAME (*)	C	D	ES CUT-CHEON	24X6	24X7	24X3	22X3	CHIUSE			ADJUSTABLE		
										LOCKS	HOOK DEVIATORS	DEADBOLT DEVIATORS	LOCKS	HOOK DEVIATORS	DEADBOLT DEVIATORS
	GLOBAL 48 PORTA	1	30	30	SI	E30	E30	E25	E25	038079	038083	038084	0386001	0387001	038710
	GLOBAL 48 SORMONTO	2	30	30	NO	/	/	E30	E30	/	/	/	0386021	0387021	/
	GLOBAL 70 TAGLIO TERMICO	2	30	45	NO	/	/	E30	E30	/	/	/	0386021	0387021	/
INDINVEST	ALPHA 255 COMPLANARE	2	30	30	NO	/	/	E25	E25	038085	038086	038087	0386031	0387031	/
	ALPHA 370 TT COMPLANARE	2	30	50	NO	/	/	E25	E25	038085	038086	038087	0386031	0387031	/
	ALPHA 445 FINESTRA	2	28	28	NO	/	/	E25	E25	038085	038086	038087	0386031	0387031	/
	ALPHA 445 PORTA 1 ANTA	1	28	28	SI	/	/	E30	E30	038085	038086	038087	0386031	0387031	/
	ALPHA 445 PORTA 2 ANTE	1	28	28	SI	E35	E35	E30	E30	038079	038083	038084	0386001	0387001	038710
	ALPHA 658 TT COMPLANARE	2	30	40	NO	/	/	E25	E25	038085	038086	038087	0386031	0387031	/
	ALPHA BLITZ 2000	1	30	50	NO	/	/	E30	E30	038085	038086	038087	0386031	0387031	/
	ALPHA GLOBO 45	2	28	28	NO	/	/	E25	E25	038085	038086	038087	0386031	0387031	/
	ALPHA GLOBO 55	2	30	30	NO	/	/	E25	E25	038085	038086	038087	0386031	0387031	/
	GOLD 400 COMPLANARE	2	28	33	NO	/	/	E30	E30	038085	038086	038087	0386011	0387011	038711
	GOLD 400 SORMONTO	3	28	33	NO	/	/	E30	E30	038085	038086	038087	0386011	0387011	038711
	GOLD 500 COMPLANARE	2	30	45	NO	/	/	E30	E30	038085	038086	038087	0386011	0387011	038711
	GOLD 500 SORMONTO	3	30	45	NO	/	/	E30	E30	038085	038086	038087	0386011	0387011	038711
	GOLD 600 COMPLANARE	2	30	55	NO	/	/	E30	E30	038085	038086	038087	0386011	0387011	038711
	GOLD 600 SORMONTO	3	30	55	NO	/	/	E30	E30	038085	038086	038087	0386011	0387011	038711
METRA	NC 45 INTERNATIONAL FINESTRA	2	30	40	NO	/	/	E30	E30	038085	038086	038087	0386011	0387011	038711
	NC 45 INTERNATIONAL PORTA	1	28	33	SI	E25	E25	E25[12]	E25	038079	038083	038084	0386001	0387001	038710
	NC 45 SUPER THERMIC FINESTRA	2	30	40	NO	/	/	E25	E25	038085	038086	038087	0386011	0387011	038711
	NC 45 SUPER THERMIC PORTA	1	28	33	SI	E30	E30	E25[12]	E25	038079	038083	038084	0386001	0387001	038710
	NC 55 INTERNATIONAL FINESTRA	2	30	50	NO	/	/	E25	E25	038085	038086	038087	0386011	0387011	038711
	NC 55 INTERNATIONAL PORTA	1	30	40	SI	E30	E30	E25[12]	E25	038079	038083	038084	0386001	0387001	038710
	NC 68 SUPER THERMIC FINESTRA	2	30	55	NO	/	/	E25	E25	038085	038086	038087	0386011	0387011	038711
	NC 68 SUPER THERMIC PORTA	1	30	45	SI	E30	E30	E25[12]	E25	038079	038083	038084	0386001	0387001	038710
	NUOVO NC 40 COMPLANARE	2	28	28	NO	/	/	E25	E25	038085	038086	038087	0386031	0387031	/
	NUOVO NC 40 SORMONTO 1 ANTA	2	28	28	NO	/	/	E25	E25	/	/	/	0386011	0387011	038711
	NUOVO NC 40 SORMONTO 2 ANTE	2	28	28	NO	/	/	E25	E25	038085	038086	038087	0386031	0387031	/
	NUOVO NC 40 SORM. 2 ANTE CON RIPORTO	2	28	28	NO	/	/	E25	E25	/	/	/	0386011	0387011	038711
	NUOVO NC 50 COMPLANARE	2	28	28	NO	/	/	E25	E25	038085	038086	038087	0386031	0387031	/
	NUOVO NC 50 PORTA	1	30	30	SI	E30	E30	E25	E25	038079	038083	038084	0386001	0387001	038710
	NUOVO NC 50 SORMONTO 1 ANTA	2	28	28	NO	/	/	E25	E25	/	/	/	0386021	0387021	/
	NUOVO NC 50 SORMONTO 2 ANTE	2	28	28	NO	/	/	E25	E25	/	/	/	0386021	0387021	/
	SUPERBLINDO	1	30	60	SI	E35	E35	E30[12]	E30	038079	038083	038084	0386001	0387001	038710
MORELLI	MA 8300	1	30	40	NO	/	/	E30	E30	038085	038086	038087	0386011	0387011	038711
NEW TEC	NEW TEC 50 PORTA COMPLANARE	1	30	35	SI	E25	E25	E25[12]	E25	038079	038083	038084	0386001	0387001	038710
	NEW TEC 50 PORTA SORMONTO	2	30	35	NO	/	/	E30	E30	/	/	/	0386021	0387021	/
	NEW TEC 52 TT PORTA COMPLANARE	1	30	35	SI	E25	E25	E25[12]	E25	038079	038083	038084	0386001	0387001	038710
	NEW TEC 52 TT PORTA SORMONTO	2	30	35	NO	/	/	E30	E30	/	/	/	0386021	0387021	/
	NEW TEC 60 TT PORTA SORMONTO	2	30	40	NO	/	/	E30	E30	/	/	/	0386021	0387021	/
	NEW TEC 68 TT PORTA COMPLANARE	1	30	55	SI	E30	E30	E25[12]	E25	038079	038083	038084	0386001	0387001	038710
	NEW TEC 68 TT PORTA SORMONTO	2	30	50	NO	/	/	E30	E30	/	/	/	0386021	0387021	/
OCMA	FC 47 FINESTRA	2	28	33	NO	/	/	E30	E30	038085	038086	038087	0386011	0387011	038711
	FC 55 FINESTRA	3	30	40	NO	/	/	E35	E35	038085	038086	038087	0386011	0387011	038711
	FC 60 TT FINESTRA	2	30	45	NO	/	/	E30	E30	038085	038086	038087	0386011	0387011	038711
	FC 60 TT PORTA	1	30	45	SI	E35[13]	E35[13]	/	/	038079	038083	038084	0386001	0387001	038710

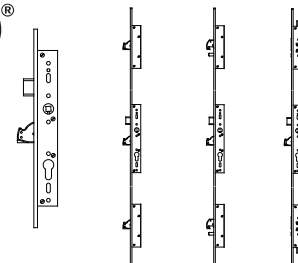

**Mortice locks  
center distance 92 mm**

FRAME MANUFACTURER	PROFILE	CYLINDER	FRONT PLATE USABLE BACKSET				MODULAR STRIKING PLATES								
							CHIUSE			ADJUSTABLE					
SERIES	FRAME (*)	C	D	ESCUTCHEON	24X6	24X7	24X3	22X3	LOCKS	HOOK DEVIATORS	DEADBOLT DEVIATORS	LOCKS	HOOK DEVIATORS	DEADBOLT DEVIATORS	
	SV 47 PORTA 1 ANTA	1	28	33	SI	E35	E35	E30[12]	E30	038079	038083	038084	0386001	0387001	038710
	SV 47 PORTA 2 ANTE	1	28	33	SI	E35	E35	E30[12]	E30	038079	038083	038084	0386001	0387001	038710
	SV 62 PORTA 1 ANTA	1	30	45	SI	E30	E30	E30[12]	E30	038079	038083	038084	0386001	0387001	038710
	SV 62 PORTA 2 ANTE	1	30	45	SI	E30	E30	E30[12]	E30	038079	038083	038084	0386001	0387001	038710
	SV 62 TT PORTA 1 ANTA	1	30	45	SI	E30	E30	E30[12]	E30	038079	038083	038084	0386001	0387001	038710
	SV 62 TT PORTA 2 ANTE	1	30	45	SI	E30	E30	E30[12]	E30	038079	038083	038084	0386001	0387001	038710
PASSERINI	EKIP 40 COMPLANARE 1 ANTA	2	28	28	NO	/	/	E25	E25	/	/	/	0386031	0387031	/
	EKIP 40 COMPLANARE 2 ANTE	2	28	28	NO	/	/	E25	E25	038085	038086	038087	0386031	0387031	/
	EKIP 40 EVOLUZIONE 1 ANTA	2	28	28	NO	/	/	E25	E25	/	/	/	0386011	0387011	038711
	EKIP 40 EVOLUZIONE 2 ANTE	2	28	28	NO	/	/	E25	E25	038085	038086	038087	0386011	0387011	038711
	EKIP 40 SORMONTO 1 ANTA	2	28	28	NO	/	/	E25	E25	/	/	/	0386011	0387011	038711
	EKIP 40 SORMONTO 2 ANTE	2	28	28	NO	/	/	E25	E25	038085	038086	038087	0386011	0387011	038711
	EKIP 50 COMPLANARE 1 ANTA	2	28	33	SI	/	/	E35	E35	/	/	/	0386031	0387031	/
	EKIP 50 COMPLANARE 2 ANTE	2	28	33	SI	/	/	E35	E35	038085	038086	038087	0386031	0387031	/
	EKIP 50 SORMONTO 1 ANTA	2	28	33	NO	/	/	E35	E35	/	/	/	0386021	0387021	/
	EKIP 50 SORMONTO 2 ANTE	2	28	33	NO	/	/	E25	E25	038085	038086	038087	0386021	0387021	/
	EKIP BLINDO	1	45	45	SI	E40	E40	E35	E35	038079	038083	038084	0386001	0387001	038710
	EKIP MAASTRICHT 53 FINESTRA	2	30	40	NO	/	/	E30	E30	038085	038086	038087	0386011	0387011	038711
	EKIP MAASTRICHT 53 PORTA 1 ANTA	1	30	40	SI	E30	E30	E25[12]	E25	038079	038083	038084	0386001	0387001	038710
	EKIP MAASTRICHT 53 PORTA 2 ANTE	1	30	35	SI	E30	E30	E25[12]	E25	038079	038083	038084	0386001	0387001	038710
	EKIP MAASTRICHT TH 60 FINESTRA	2	30	45	NO	/	/	E30	E30	038085	038086	038087	0386011	0387011	038711
	EKIP MAASTRICHT TH 60 PORTA 1 ANTA	1	30	45	SI	E30	E30	E25[12]	E25	038079	038083	038084	0386001	0387001	038710
	EKIP MAASTRICHT TH 60 PORTA 2 ANTE	1	30	40	SI	E30	E30	E25[12]	E25	038079	038083	038084	0386001	0387001	038710
	EKIP MAASTRICHT TH 68 FINESTRA	2	30	55	NO	/	/	E30	E30	038085	038086	038087	0386011	0387011	038711
	EKIP MAASTRICHT TH 68 PORTA 1 ANTA	1	30	55	SI	E30	E30	E25[12]	E25	038079	038083	038084	0386001	0387001	038710
	EKIP MAASTRICHT TH 68 PORTA 2 ANTE	1	30	50	SI	E30	E30	E25[12]	E25	038079	038083	038084	0386001	0387001	038710
	EKIP THERMO 53 FINESTRA 1 ANTA	2	30	40	NO	/	/	E25	E25	/	/	/	0386031	0387031	/
	EKIP THERMO 53 FINESTRA 2 ANTE	2	30	40	NO	/	/	E25	E25	038085	038086	038087	0386031	0387031	/
	EKIP THERMO 53 PORTA	1	30	40	SI	E30	E30	E25[12]	E25	038079	038083	038084	0386001	0387001	038710
PROFILATI	"PE ""EKU 53"" FINESTRA"	2	30	40	NO	/	/	E30	E30	038085	038086	038087	0386011	0387011	038711
	"PE ""EKU 53"" PORTA"	1	30	30	SI	E25	E25	E25[12]	E25	038079	038083	038084	0386001	0387001	038710
	"PE ""EKU 64 TT"" FINESTRA"	2	30	50	NO	/	/	E30	E30	038085	038086	038087	0386011	0387011	038711
	"PE ""EKU 64 TT"" PORTA"	1	30	40	SI	E25	E25	E25[12]	E25	038079	038083	038084	0386001	0387001	038710
	"PE ""EKU 72 TT"" FINESTRA"	2	30	60	NO	/	/	E30	E30	038085	038086	038087	0386011	0387011	038711
	"PE ""EKU 72 TT"" PORTA"	1	30	50	SI	E25	E25	E25[12]	E25	038079	038083	038084	0386001	0387001	038710
	SISTEMA 1 PE 40 COMP./EST. 1 ANTA	2	28	33	NO	/	/	E25	E25	/	/	/	0386011	0387011	038711
	SISTEMA 1 PE 40 COMP./EST. 2 ANTE	2	28	33	NO	/	/	E25	E25	038079	038083	038084	0386031	0387031	/
	SISTEMA 1 PE 40 SORMONTO 1 ANTA	2	28	28	NO	/	/	E25	E25	/	/	/	0386011	0387011	038711
	SISTEMA 1 PE 40 SORMONTO 2 ANTE	2	28	28	NO	/	/	E25	E25	038079	038083	038084	0386031	0387031	/
	SISTEMA 1 PE 50 COMP./EST. 1 ANTA	2	30	40	NO	/	/	E30	E30	/	/	/	0386011	0387011	038711
	SISTEMA 1 PE 50 COMP./EST. 2 ANTE	2	30	40	NO	/	/	E30	E30	038085	038086	038087	0386031	0387031	/
	SISTEMA 1 PE 50 SORMONTO 1 ANTA	2	30	35	NO	/	/	E30	E30	/	/	/	0386011	0387011	038711
	SISTEMA 1 PE 50 SORMONTO 2 ANTE	2	30	35	NO	/	/	E30	E30	038085	038086	038087	0386031	0387031	/
SCHÜCO	ROYAL 78 ST BLINDATO	1	40	40	SI	E30	E30	E25[12]	E25	038079	038083	038084	0386001	0387001	038710
	ROYAL S 50 N	1	30	30	SI	E35	/	E30[12]	E30	038079	038083	038084	0386001	0387001	038710
	ROYAL S 55 TT	1	30	40	SI	E35	/	E30[12]	E30	038079	038083	038084	0386001	0387001	038710
	ROYAL S 65 TT	1	30	50	SI	E35	/	E30[12]	E30	038079	038083	038084	0386001	0387001	038710
WICONA	L60-A	1	30	45	SI	E35	E35	E30[12]	E30	038079	038083	038084	0386001	0387001	038710
	L70-A	1	30	50	SI	E40	E40	E35[12]	E35	038079	038083	038084	0386001	0387001	038710

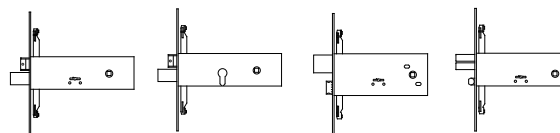

**Locks for mid-rail frames:  
double bit and profile cylinder**

PROFILE		STRIKING PLATES		
		ADJUSTABLE	NYLON	
FRAME MANUFACTURER	SERIES	ONE TYPE FOR ALL VERSIONS	DEADBOLT LATCHBOLT/ROLLER AND ELECTRIC	DEADBOLT ONLY HOOK AND DEVIATORS ONLY
ALCAN	ABITHAL CRISTAL	0387011	038919	038519
	ABITHAL KEEPER PORTA 53-60	0387001	/	/
	ABITHAL KEEPER PORTA 61-68	0387001	/	/
	ABITHAL KEEPER PORTA C.E.	0387011	038919	038519
	ABITHAL PORTA	0387001	038911[1]	038511
	WINNER FINESTRA	0387011	038919	038519
	WINNER PORTA	0387001	038911[1]	038511
ALCOA	ALUBLIND	0387021	/	/
	FB 12 BLINDATO	0387001	038915[1]	038515
	FB 12 GA / EUROPA GA	0387011	038919	038519
	FB 12 T.T.	0387011	038919	038519
	FB 12 TRAD./REVAMPING	/	038914[1]	038514
	FORMULA F40 PORTA	0387001	039921[1]	038521
	FORMULA F40 TT PORTA	0387001	038921[1]	038521
	FORMULA F50 PORTA	0387001	038921[1]	038521
	FORMULA F50 TT PORTA	0387001	038921[1]	038521
	FORMULA F60 TT PORTA	0387001	038921[1]	038521
	GR 9	/	038915[1]	038515
	PLANA 1 ANTA	0387001	038915	038515
	PLANA 2 ANTE	0387001	038913	038513
	R 35 REVERSIBILE	0387011	038919	038519
	R 35 SORMONTO	0387011	038919	038519
	R 40 REVERSIBILE 1 ANTA	0387021	038912	038512
	R 40 REVERSIBILE 2 ANTE	0387021	038912	038512
	R 40 SORMONTO 1 ANTA	0387021	038912	038512
	R 40 SORMONTO 2 ANTE	0387021	038912	038512
	R 50 SORMONTO 1 ANTA	0387021	038912	038512
R 50 SORMONTO 2 ANTE	0387021	038912	038512	
R 50 TT SORMONTO 1 ANTA	0387021	038912	038512	
R 50 TT SORMONTO 2 ANTE	0387021	038912	038512	
R 60 TT COMPLANARE	0387021	038912	038512	
ALL.CO FINAL	ALL.CO 5 COMPLANARE	0387031	038921	038521
	ALL.CO 5 PORTA	0387001	038911	038511
	ALL.CO 5 REVERSIBILE	0387021	038922	038522
	ALL.CO 5 SORMONTO	0387021	038922	038522
	ALL.CO 5 TT PORTA	0387001	038911	038511
	EXPORT 40 FINESTRA	0387011	038919	038519
	EXPORT 45 TT	0387011	/	/
	EXPORT 50 FINESTRA	0387011	038919	/
	EXPORT 50 PORTA	0387001	038911[1]	038511
	EXPORT 50 TT FINESTRA	0387011	038919	/
	EXPORT 50 TT PORTA	0387001	038911[1]	038511
	FINAL 40 FINESTRA	0387011	038919	038519
	ITES P4 COMPLANARE	0387031	038921	038521
	ITES P4 SORMONTO	0387021	038920	038520
	SICURBLIN 65	0387001	038911	038511
	SICURBLIN C.E.	0387011	/	/
	ALNOR	BLINDO BLOCK	0387031	038921
MONTREAL G.A.		0387031	038921	038521
MONTREAL PORTA		0387001	038911[1]	038511

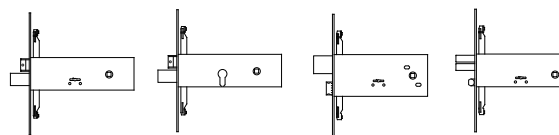
**Locks for mid-rail frames:  
double bit and profile cylinder**

PROFILE		STRIKING PLATES		
		ADJUSTABLE	NYLON	
FRAME MANUFACTURER	SERIES	ONE TYPE FOR ALL VERSIONS	DEADBOLT LATCHBOLT/ROLLER AND ELECTRIC	DEADBOLT ONLY HOOK AND DEVIATORS ONLY
ALUSUISSE	ALSEC 2000 FINESTRA 59	0387011	038919	038519
	ALSEC 2000 FINESTRA 69	0387011	038919	038519
	ALSEC 2000 PORTA 59	0387001	038911[1]	038511
	ALSEC 2000 PORTA 69	0387001	038911[1]	038511
ALU-K	ALUBLINDO	0387001	038911	038511
	N 45 PORTA	0387001	038911	038511
	N 45 REVERSIBILE	0387021	/	/
	N 53 COMPLANARE	0387031	038921	038521
	N 53 PORTA	0387001	038911	038511
	N 55 TT COMPLANARE	0387031	038921	038521
	N 55 TT PORTA	0387001	038911	038511
N 62 TT PORTA	0387001	038911	038511	
ALU-MEC	SYNTHESIS 45 FINESTRA	0387011	038919	/
	SYNTHESIS 57 FINESTRA	0387011	038919	/
	SYNTHESIS 57 PORTA	0387001	038921	038521
	SYNTHESIS 60 TT FINESTRA	0387011	038919	/
	SYNTHESIS 60TT PORTA	0387001	038911	038511
BODEGA	BGA 50	0387011	038919	038519
	EXTRABLIND 70	0387001	038921[1]	038521
	NEW BT 60	0387011	038919	038519
DOMAL	DOMAL BREAK 52 FINESTRA	0387011	038919	038519
	DOMAL BREAK 52 PORTA	0387001	038911	038511
	DOMAL BREAK 70 FINESTRA	0387011	038919	038519
	DOMAL BREAK 70 PORTA	0387001	038921[1]	038521
	DOMAL SECURITY PORTA	0387001	038911	038511
	DOMAL SHOPS PORTA	0387001	038911[1]	038511
	DOMAL STOPPER PG FINESTRA	0387011	038919	038519
	DOMAL STOPPER PG PORTA	0387001	038911	038511
EQUIPE	SISTEMA 8000 G.A. FINESTRA 1 ANTA	0387011	038919	038519
	SISTEMA 8000 G.A. FINESTRA 2 ANTE	0387011	038919	038519
	SISTEMA 8000 TT FINESTRA 1 ANTA	0387011	/	/
	SISTEMA 8000 TT FINESTRA 2 ANTE	0387011	/	/
ESA	BLINDAL 60 PORTA 1 ANTA	0387001	038915	038515
	BLINDAL 60 PORTA 2 ANTE	0387001	038915	038515
	BLINDAL 70 PORTA 1 ANTA	0387001	/	/
	BLINDAL 70 PORTA 2 ANTE	0387001	/	/
	GIUNTALL COMPLANARE	0387031	038922	038522
	GIUNTALL PORTA	0387021	038921	038521
	ISOLA PORTA	0387011	038919	038519
ESEDRA	GA 53 PORTA	0387011	038919	038519
	TT 63 PORTA	0387011	038919	038519
	TT 75 PORTA	0387011	038919	038519
FRESIA	GLOBAL 41 COMPLANARE	0387021	/	/
	GLOBAL 41 SORMONTO	0387021	/	/
	GLOBAL 48 COMPLANARE	0387021	/	/

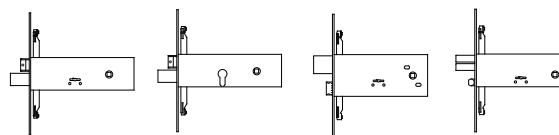

**Locks for mid-rail frames:  
double bit and profile cylinder**

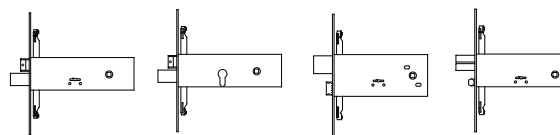
PROFILE		STRIKING PLATES		
		ADJUSTABLE	NYLON	
FRAME MANUFACTURER	SERIES	ONE TYPE FOR ALL VERSIONS	DEADBOLT LATCHBOLT/ROLLER AND ELECTRIC	DEADBOLT ONLY HOOK AND DEVIATORS ONLY
	GLOBAL 48 PORTA GLOBAL 48 SORMONTO GLOBAL 70 TAGLIO TERMICO	0387001 0387021 0387021	/ / /	/ / /
INDINVEST	ALPHA 255 COMPLANARE ALPHA 370 TT COMPLANARE ALPHA 445 FINESTRA ALPHA 445 PORTA 1 ANTA ALPHA 445 PORTA 2 ANTE ALPHA 658 TT COMPLANARE ALPHA BLITZ 2000 ALPHA GLOBO 45 ALPHA GLOBO 55 GOLD 400 COMPLANARE GOLD 400 SORMONTO GOLD 500 COMPLANARE GOLD 500 SORMONTO GOLD 600 COMPLANARE GOLD 600 SORMONTO	0387031 0387031 0387031 0387031 0387001 0387031 0387031 0387031 0387031 0387011 0387011 0387011 0387011 0387011 0387011 0387011	038913[1] 038913 038921 038921 038923 038016 038913 038921 038913[1] 038919 038919 038919 038919 038919 038919 038919	038513 038513 / 038521 038523 / 038513 / 038513 038519 038519 038519 038519 038519 038519
METRA	NC 45 INTERNATIONAL FINESTRA NC 45 INTERNATIONAL PORTA NC 45 SUPERTHERMIC FINESTRA NC 45 SUPERTHERMIC PORTA NC 55 INTERNATIONAL FINESTRA NC 55 INTERNATIONAL PORTA NC 68 SUPERTHERMIC FINESTRA NC 68 SUPERTHERMIC PORTA NUOVO NC 40 COMPLANARE NUOVO NC 40 SORMONTO 1 ANTA NUOVO NC 40 SORMONTO 2 ANTE NUOVO NC 40 SORM. 2 ANTE CON RIPORTO NUOVO NC 50 COMPLANARE NUOVO NC 50 PORTA NUOVO NC 50 SORMONTO 1 ANTA NUOVO NC 50 SORMONTO 2 ANTE SUPERBLINDO	0387011 0387001 0387011 0387001 0387011 0387001 0387011 0387001 0387031 0387011 0387031 0387011 0387031 0387001 0387021 0387021 0387001	038919 038911 038919 038911 038919 038911 038919 038911[1] 038921 038920 038921 / / 038911 038923 038923 038911	038519 038511 038519 038511 038519 038511 038519 038511 038521 038520 038521 / / 038511 038523 038523 038511
MORELLI	MA 8300	0387011	038919	038519
NEW TEC	NEW TEC 50 PORTA COMPLANARE NEW TEC 50 PORTA SORMONTO NEW TEC 52 TT PORTA COMPLANARE NEW TEC 52 TT PORTA SORMONTO NEW TEC 60 TT PORTA SORMONTO NEW TEC 68 TT PORTA COMPLANARE NEW TEC 68 TT PORTA SORMONTO	0387001 0387021 0387001 0387021 0387021 0387001 0387021	038921 038912 038921 038912 038912 038921 038912	038521 038512 038521 038512 038512 038521 038512
OCMA	FC 47 FINESTRA FC 55 FINESTRA FC 60 TT FINESTRA FC 60 TT PORTA SV 47 PORTA 1 ANTA	0387011 0387011 0387011 / 0387001	038919 038919 038919 038921 /	038519 038519 038519 038521 /

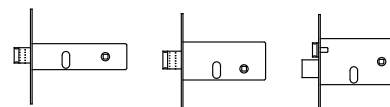

**Locks for mid-rail frames:  
double bit and profile cylinder**

PROFILE		STRIKING PLATES		
		ADJUSTABLE	IN NYLON	
FRAME MANUFACTURER	SERIES	ONE TYPE FOR ALL VERSIONS	DEADBOLT LATCHBOLT ROLLER AND ELECTRIC	DEADBOLT ONLY HOOK AND DEVIATORS ONLY
	SV 47 PORTA 2 ANTE SV 62 PORTA 1 ANTA SV 62 PORTA 2 ANTE SV 62 TT PORTA 1 ANTA SV 62 TT PORTA 2 ANTE	0387001 0387001 0387001 0387001 0387001	/ / / / /	/ / / / /
PASSERINI	EKIP 40 COMPLANARE 1 ANTA EKIP 40 COMPLANARE 2 ANTE EKIP 40 EVOLUZIONE 1 ANTA EKIP 40 EVOLUZIONE 2 ANTE EKIP 40 SORMONTO 1 ANTA EKIP 40 SORMONTO 2 ANTE EKIP 50 COMPLANARE 1 ANTA EKIP 50 COMPLANARE 2 ANTE EKIP 50 SORMONTO 1 ANTA EKIP 50 SORMONTO 2 ANTE EKIP BLINDO EKIP MAASTRICHT 53 FINESTRA EKIP MAASTRICHT 53 PORTA 1 ANTA EKIP MAASTRICHT 53 PORTA 2 ANTE EKIP MAASTRICHT TH 60 FINESTRA EKIP MAASTRICHT TH 60 PORTA 1 ANTA EKIP MAASTRICHT TH 60 PORTA 2 ANTE EKIP MAASTRICHT TH 68 FINESTRA EKIP MAASTRICHT TH 68 PORTA 1 ANTA EKIP MAASTRICHT TH 68 PORTA 2 ANTE EKIP THERMO 53 FINESTRA 1 ANTA EKIP THERMO 53 FINESTRA 2 ANTE EKIP THERMO 53 PORTA	0387031 0387031 0387011 0387011 0387011 0387011 0387031 0387031 0387021 0387021 0387001 0387011 0387001 0387001 0387011 0387001 0387001 0387011 0387001 0387001 0387001 0387011 0387001 0387001 0387001 0387031 0387031 0387001	038921 038921 038920 038919 038920 038919 038016 038913 038923 038919 / 038919 038911 038911 038919 038911 038911 038919 038911 038911 038911 / 038921 038911	038521 038521 038520 038519 038520 038519 / 038513 038523 038519 / 038519 038511 038511 038519 038511 038511 038519 038511 038511 / 038521 038511
PROFILATI	"PE ""EKU 53"" FINESTRA" "PE ""EKU 53"" PORTA" "PE ""EKU 64 TT"" FINESTRA" "PE ""EKU 64 TT"" PORTA" "PE ""EKU 72 TT"" FINESTRA" "PE ""EKU 72 TT"" PORTA" SISTEMA PE 1 40 COMP./EST. 1 ANTA SISTEMA PE 1 40 COMP./EST. 2 ANTE SISTEMA PE 1 40 SORMONTO 1 ANTA SISTEMA PE 1 40 SORMONTO 2 ANTE SISTEMA PE 1 50 COMP./EST. 1 ANTA SISTEMA PE 1 50 COMP./EST. 2 ANTE SISTEMA PE 1 50 SORMONTO 1 ANTA SISTEMA PE 1 50 SORMONTO 2 ANTE	0387011 0387001 0387011 0387001 0387011 0387001 0387011 0387031 0387011 0387031 0387011 0387031 0387011 0387031 0387011 0387031 0387011	038919 038921 038919 038921 038919 038921 038920 038921 038920 038921 038920 038921 038920 038921 038920 038921	038519 038521 038519 038521 038519 038521 038520 038521 038520 038521 038520 038521 038520 038521
SCHÜCO	ROYAL 78 ST BLINDATO ROYAL S 50 N ROYAL S 55 TT ROYAL S 65 TT	0387001 0387001 0387001 0387001	038911[1] / / /	038511 / / /
WICONA	L60-A L70-A	0387001 0387001	038911 038911	038511 038511



**Locks for mid-rail frames  
with oval cylinder**

PROFILE			CYLINDER		FRONT PLATE USABLE BACKSET		STRIKING PLATES	
FRAME MANUFACTURER	SERIES				16	20	ADJUSTABLE	NYLON
			C	D				
ALCAN	ABITHAL FINESTRA	1	27	40		E60	0387011	033027
	ABITHAL FINESTRA	1	27	40		E70	0387011	033027
	ABITHAL FINESTRA	2	27	40		E70	0387011	033027
	WINNER FINESTRA	1	27	33		E70	0387011	033027
ALCOA	FB 12 GA / EUROPA GA	1	27	33		E60	0387011	033027
	FB 12 GA / EUROPA GA	2	27	33		E70	0387011	033027
	FB 12 T.T.	1	27	33		E60	0387011	033027
	FB 12 T.T.	2	27	33		E70	0387011	033027
	FB 12 TRAD./REVAMPING	1	27	27	E60		/	033051
	FB 12 TRAD./REVAMPING	2	27	27	E70		/	033051
	FB 12 TRAD./REVAMPING	3	27	27	E80		/	033051
	GR 9	1	27	27		E60	/	033051
	GR 9	2	27	27		E70	/	033051
	PLANA 1 ANTA	1	27	27		E60	0387001	033050
	PLANA 1 ANTA	2	27	27		E70	0387001	033050
	PLANA 2 ANTE	1	27	27		E60	0387001	033028
	PLANA 2 ANTE	2	27	27		E70	0387001	033028
	R 35 REVERSIBILE	1	27	27	E80		0387011	033027
	R 35 SORMONTO	1	27	27	E80		0387011	033027
	R 40 REVERSIBILE 1 ANTA / 2 ANTE	1	27	27		E60	0387011	033065
	R 40 REVERSIBILE 1 ANTA / 2 ANTE	1	27	27		E70	0387011	033065
	R 40 REVERSIBILE 1 ANTA / 2 ANTE	2	27	27		E80	0387011	033065
	R 40 SORMONTO 1 ANTA / 2 ANTE	1	27	27		E60	0387011	033065
	R 40 SORMONTO 1 ANTA / 2 ANTE	1	27	27		E70	0387011	033065
R 40 SORMONTO 1 ANTA / 2 ANTE	2	27	27		E80	0387011	033065	
R 50 SORMONTO 1 ANTA / 2 ANTE	1	27	27		E60	0387011	033064 / 033065	
R 50 SORMONTO 1 ANTA / 2 ANTE	1	27	27		E70	0387011	033064 / 033065	
R 50 TT SORMONTO 1 ANTA / 2 ANTE	1	27	33	E60	E60	0387011	033064 / 033065	
R 50 TT SORMONTO 1 ANTA / 2 ANTE	1	27	33	E70	E70	0387011	033064 / 033065	
R 60 TT COMPLANARE	1	27	40		E70	0387011	033065	
ALL.CO FINAL ITES	ALL.CO 5 COMPLANARE	1	27	27	E60		0387031	033026[4]
	ALL.CO 5 COMPLANARE	1	27	27	E70		0387031	033026[4]
	ALL.CO 5 COMPLANARE	2	27	27	E70		0387031	033026[4]
	ALL.CO 5 REVERSIBILE	1	27	27		E60	0387021	033030
	ALL.CO 5 REVERSIBILE	1	27	27		E70	0387021	033030
	ALL.CO 5 REVERSIBILE	2	27	27		E70	0387021	033030
	ALL.CO 5 SORMONTO	1	27	33		E60	0387021	033030
	ALL.CO 5 SORMONTO	1	27	33		E70	0387021	033030
	ALL.CO 5 SORMONTO	2	27	33		E70	0387021	033030
	EXPORT 40 FINESTRA	1	30	40		E70[15]	0387011	033027
	EXPORT 50 FINESTRA	1	30	40		E70	0387011	033027
	EXPORT 50 FINESTRA	2	30	40		E80	0387011	033027
	ITES P4 COMPLANARE	1	27	27	E70[15]		0387031	033026[4]
	ITES P4 COMPLANARE	2	27	27	E80[15]		0387031	033026[4]
	ITES P4 SORMONTO	1	27	27	E70[15]		0387021	033029[4]
	ITES P4 SORMONTO	2	27	27	E80[15]		0387021	033029[4]
	VZ 400 / VZ 400 S	1	27	27	E60		/	033051
	VZ 400 / VZ 400 S	2	27	27	E70		/	033051
	VZ 500 / VZ 400 P	1	27	27	E60		/	033050
	VZ 500 / VZ 400 P	2	27	27	E60		/	033050
	VZ 500 / VZ 400 P	3	27	27	E70		/	033050

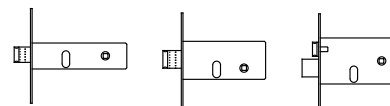

**Locks for mid-rail frames  
with oval cylinder**

PROFILE		CYLINDER		FRONT PLATE USABLE BACKSET		STRIKING PLATES		
FRAME MANUFACTURER	SERIES				16	20	ADJUSTABLE	NYLON
			C	D				
	VZ 500 / VZ 400 P	4	27	27	E80		/	033050
ALNOR	400	1	27	27	E60		/	033051
	400	2	27	27	E70		/	033051
	500	1	27	27	E60		/	033050
	500	2	27	27	E60		/	033050
	500	3	27	27	E70		/	033050
	MONTREAL G.A.	1	27	27		E70	0387031	
ALU-K	N 45 COMPLANARE	1	27	27		E70	0387031	033026
	N 45 REVERSIBILE	1	27	27		E70	0387021	/
	N 53 COMPLANARE	1	27	40		E70	0387031	033026
	N 55 TT COMPLANARE	1	27	40		E70	0387031	033026
ALU-MEC	SYNTHESIS 45 FINESTRA	1	27	27		E70	0387011	033027
	SYNTHESIS 57 FINESTRA	1	27	27		E70	0387011	033027
	SYNTHESIS 60 TT FINESTRA	1	27	27		E70	0387011	033027
	F 40	1	27	27	E60		/	033051
	F 40	2	27	27	E70		/	033051
	F 50	1	27	27	E60		/	033050
	F 50	2	27	27	E60		/	033050
	F 50	3	27	27	E70		/	033050
BODEGA	BGA 50	1	27	40		E60	0387011	033027
	BGA 50	1	27	40		E70	0387011	033027
	BGA 50	2	27	40		E80	0387011	033027
	BO 40 / 900	1	27	27	E60		/	033050
	BO 40 / 900	2	27	27	E70		/	033050
	BO 50	1	27	27	E60		/	033051
	BO 50	2	27	27	E70		/	033051
DOMAL	DOMAL BREAK 52 FINESTRA	1	27	40		E70	0387011	033027
	DOMAL STOPPER PG FINESTRA	1	27	40		E70	0387011	033027
	DOMAL 40 SORMONTO 1 ANTA	1	27	27	E60		/	033029
	DOMAL 40 SORMONTO 1 ANTA	2	27	27	E70		/	033029
	DOMAL 40 SORMONTO 2 ANTE	1	27	27	E60		/	033028
	DOMAL 40 SORMONTO 2 ANTE	2	27	27	E70		/	033028
EQUIPE	EMAL 40 W	1	27	27		E70	0387011	033027
	SISTEMA 8000 G.A. FINESTRA 1 ANTA	1	27	33		E70	0387011	033027
	SISTEMA 8000 G.A. FINESTRA 2 ANTE	1	27	33		E70	0387011	033027
ESA	GIUNTALL COMPLANARE	1	27	27		E60	0387031	033026
	GIUNTALL COMPLANARE	1	27	27		E70	0387031	033026
	GIUNTALL COMPLANARE	2	27	27		E70	0387031	033026
	GIUNTALL COMPLANARE	2	27	27		E80	0387031	033026
	GIUNTALL SORMONTO	1	27	33		E60	0387031	033026
	GIUNTALL SORMONTO	1	27	33		E70	0387031	033026
	GIUNTALL SORMONTO	2	27	33		E70	0387031	033026
	GIUNTALL SORMONTO	2	27	33		E80	0387031	033026
	ISOLA COMPLANARE	1	27	40		E70	0387031	033026
	ISOLA SORMONTO	1	30	30		E70	0387031	033026
	NT 40 G	1	27	27	E60		/	033051



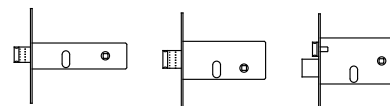

**Locks for mid-rail frames  
with oval cylinder**

PROFILE		CYLINDER		FRONT PLATE USABLE BACKSET		STRIKING PLATES		
FRAME MANUFACTURER	SERIES				16	20	ADJUSTABLE	NYLON
			C	D				
	NT 40 G	2	27	27	E70		/	033051
	NT 45 G 1 ANTA	1	27	27	E60		/	033065
	NT 45 G 1 ANTA	1	27	27	E70		/	033065
	NT 45 G 1 ANTA	2	27	27	E80		/	033065
	NT 45 G 2 ANTE	1	27	27		E60	/	033064
	NT 45 G 2 ANTE	1	27	27		E70	/	033064
	NT 45 G 2 ANTE	2	27	27		E80	/	033064
	NT 50 G	1	27	27	E60		/	033050
	NT 50 G	2	27	27	E70		/	033050
ESEDRA	GA 53 PORTA	1	27	33		E70	0387011	033027
	GA 53 PORTA	2	27	33		E80	0387011	033027
	GA 53 PORTA	3	27	33		E80	0387011	033027
	TT 63 PORTA	1	27	40		E70	0387011	033027
	40 PIANO	1	27	27		E70	/	033051
	50 PIANO	1	27	27	E60		/	033050
	50 PIANO	1	27	27	E70		/	033050
	50 PIANO	2	27	27	E80		/	033050
FRESIA	FT 40	1	27	27	E60		/	033051
	FT 40	2	27	27	E70		/	033051
	FT 50	1	27	27	E60		/	033050
INDINVEST	ALPHA 255 COMPLANARE	1	30	30		E70	0387031	033028
	ALPHA 255 COMPLANARE	2	30	30		E80	0387031	033028
	ALPHA 445 FINESTRA	1	27	27		E70	0387031	033026
	ALPHA 445 FINESTRA	2	27	27		E80	0387031	033026
	ALPHA GLOBO 45	1	27	27		E70	0387031	033026
	ALPHA GLOBO 45	2	27	27		E80	0387031	033026
	ALPHA GLOBO 55	1	27	27		E70	0387031	033028
	ALPHA GLOBO 55	2	27	27		E80	0387031	033028
	GOLD 400 COMPLANARE	1	27	27		E70	0387011	033027
	GOLD 400 SORMONTO	1	27	27		E70	0387011	033027
	GOLD 500 COMPLANARE	1	27	40		E70	0387011	033027
	GOLD 500 SORMONTO	1	27	40		E70	0387011	033027
	TE 40/45	1	27	27	E60		/	033051
	TE 40/45	2	27	27	E70		/	033051
	TE 50	1	27	27	E60		/	033050
	TE 50	2	27	27	E60		/	033050
	TE 50	3	27	27	E70		/	033050
	TE 50	4	27	27	E80		/	033050
METRA	NC 45 INTERNATIONAL FINESTRA	1	27	40		E60	0387011	033027
	NC 45 INTERNATIONAL FINESTRA	1	27	40		E70	0387011	033027
	NC 45 INTERNATIONAL FINESTRA	2	27	40		E80	0387011	033027
	NC 45 SUPERTHERMIC FINESTRA	1	27	40	E60		0387011	033027[4]
	NC 45 SUPERTHERMIC FINESTRA	1	27	40	E70		0387011	033027[4]
	NC 45 SUPERTHERMIC FINESTRA	2	27	40	E80		0387011	033027[4]
	NUOVO NC 40 COMPLANARE	1	27	27	E70		0387031	033026[4]
	NUOVO NC 40 COMPLANARE	2	27	27	E80		0387031	033026[4]
	NUOVO NC 40 SORMONTO 1 ANTA	1	27	27		E60	0387011	033029
	NUOVO NC 40 SORMONTO 1 ANTA	1	27	27		E70	0387011	033029
	NUOVO NC 40 SORMONTO 1 ANTA	2	27	27		E80	0387011	033029

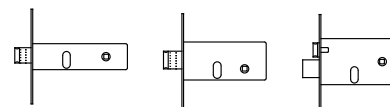

**Locks for mid-rail frames  
with oval cylinder**

PROFILE		CYLINDER		FRONT PLATE USABLE BACKSET		STRIKING PLATES		
FRAME MANUFACTURER	SERIES				16	20	ADJUSTABLE	NYLON
			C	D				
	NUOVO NC 40 SORMONTO 2 ANTE	1	27	27	E70		0387031	033026[4]
	NUOVO NC 40 SORMONTO 2 ANTE	2	27	27	E80		0387031	033026[4]
	NUOVO NC 50 COMPLANARE	1	27	27	E70		0387031	033026[4]
	NUOVO NC 50 COMPLANARE	2	27	27	E80		0387031	033026[4]
	NUOVO NC 50 SORMONTO 1 ANTA / 2 ANTE	1	27	27		E60	0387021	033030
	NUOVO NC 50 SORMONTO 1 ANTA / 2 ANTE	1	27	27		E70	0387021	033030
	NUOVO NC 50 SORMONTO 1 ANTA / 2 ANTE	2	27	27		E80	0387021	033030
	NC 40 / 40 L	1	27	27	E60		/	033051
	NC 40 / 40 L	2	27	27	E70		/	033051
	NC 50 B	1	27	27	E60		/	033050
	NC 50 B	2	27	27	E60		/	033050
	NC 50 B	3	27	27	E70		/	033050
	NC 50 B	4	27	27	E80		/	033050
	MORELLI	MA 8300	1	27	33		E80	0387011
OCMA	FC 47 FINESTRA	1	27	33		E70	0387011	033027
	FC 55 FINESTRA	1	27	40		E70	0387011	033027
	FC 55 FINESTRA	2	27	40		E80	0387011	033027
	FC 60 TT FINESTRA	1	27	40		E70	0387011	033027
PASSERINI	EKIP 40 COMPLANARE	1	27	27	E70		0387031	/
	EKIP 40 COMPLANARE	2	27	27	E80		0387031	/
	EKIP 40 EVOLUZIONE 1 ANTA	1	27	27		E70	0387011	033029
	EKIP 40 EVOLUZIONE 1 ANTA	2	27	27		E80	0387011	033029
	EKIP 40 EVOLUZIONE 2 ANTE	1	27	27		E70	0387011	033027
	EKIP 40 EVOLUZIONE 2 ANTE	2	27	27		E80	0387011	033027
	EKIP 40 SORMONTO 1 ANTA	1	27	27		E70	0387011	033029
	EKIP 40 SORMONTO 1 ANTA	2	27	27		E80	0387011	033029
	EKIP 40 SORMONTO 2 ANTE	1	27	27		E70	0387011	033027
	EKIP 40 SORMONTO 2 ANTE	2	27	27		E80	0387011	033027
	EKIP 50 COMPLANARE	1	27	33	E70		0387031	/
	EKIP 50 COMPLANARE	2	27	33	E80		0387031	/
	EKIP 50 SORMONTO 1 ANTA	1	27	33		E70	0387021	033029
	EKIP 50 SORMONTO 1 ANTA	2	27	33		E80	0387021	033029
	EKIP 50 SORMONTO 2 ANTE	1	27	33		E70	0387011	033027
	EKIP 50 SORMONTO 2 ANTE	2	27	33		E80	0387011	033027
	EKIP MAASTRICHT 53 FINESTRA	1	27	40	E70	E70	0387011	033027
	EKIP THERMO 53 FINESTRA 1 ANTA	1	27	40	E70		0387031	/
	EKIP THERMO 53 FINESTRA 1 ANTA	2	27	40	E80		0387031	/
	EKIP THERMO 53 FINESTRA 2 ANTE	1	27	40	E70		0387031	033026[4]
	EKIP THERMO 53 FINESTRA 2 ANTE	2	27	40	E80		0387031	033026[4]
	T.G.P. 40	1	27	27	E60		/	033051
	T.G.P. 40	2	27	27	E70		/	033051
T.G.P. 50	1	27	27	E60		/	033050	
T.G.P. 50	2	27	27	E60		/	033050	
T.G.P. 50	3	27	27	E70		/	033050	
PROFILATI	"PE ""EKU 53"" FINESTRA"	1	27	40		E70	0387011	/
	SISTEMA PE 1 40 COMP./EST. 1 ANTA	1	27	40		E70	0387011	/
	SISTEMA PE 1 40 COMP./EST. 1 ANTA	2	27	40		E80	0387011	/
	SISTEMA PE 1 40 COMP./EST. 2 ANTE	1	27	40	E70	E70	0387031	/
	SISTEMA PE 1 40 COMP./EST. 2 ANTE	2	27	40	E80	E80	0387031	/

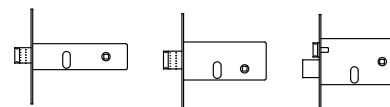

**Locks for mid-rail frames  
with oval cylinder**

PROFILE		CYLINDER		FRONT PLATE USABLE BACKSET		Striking plates		
FRAME MANUFACTURER	SERIES				16	20	ADJUSTABLE	IN NYLON
			C	D				
	SISTEMA PE 1 40 SORMONTO 1 ANTA	1	30	30		E70	0387011	/
	SISTEMA PE 1 40 SORMONTO 1 ANTA	2	30	30		E80	0387011	/
	SISTEMA PE 1 40 SORMONTO 2 ANTE	1	30	30	E70	E70	0387031	/
	SISTEMA PE 1 40 SORMONTO 2 ANTE	2	30	30	E80	E80	0387031	/
	SISTEMA PE 1 50 COMP./EST. 1 ANTA	1	30	40		E70	0387011	/
	SISTEMA PE 1 50 COMP./EST. 2 ANTE	1	30	40	E70	E70	0387031	/
	SISTEMA PE 1 50 SORMONTO 1 ANTA	1	27	40		E70	0387011	/
	SISTEMA PE 1 50 SORMONTO 2 ANTE	1	27	40	E70	E70	0387031	/

**Danish Seller**

**Swissdoor ApS**  
Stenhuggervej 2  
5471 Soendersoe  
Denmark  
VAT nr.: 32084222  
Tlf. nr.: +45 8628 0000  
mail@swissdoor.dk  
www.swissdoor.dk