

ECO **Newton** TS-14

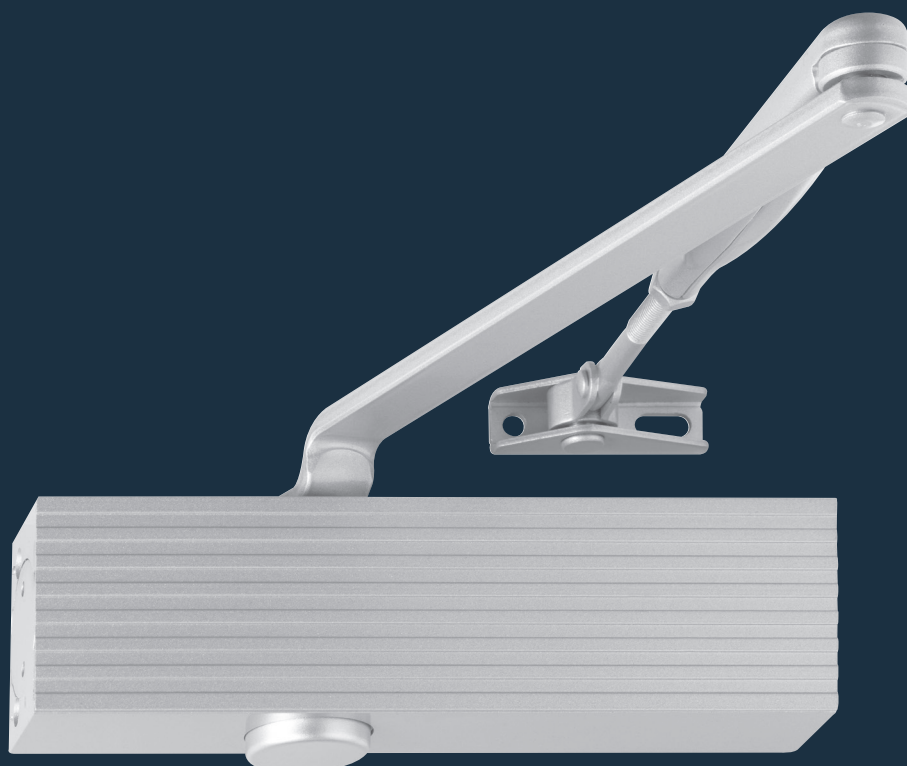

## Product information



### ■ SYSTEM TECHNOLOGY FOR THE DOOR

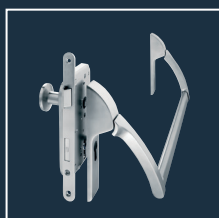
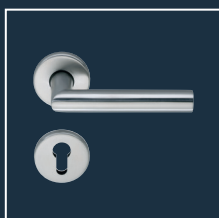
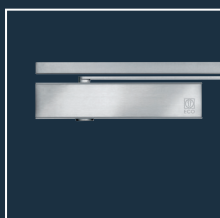

**SWISSDOOR**  
DØRTEKNIK FOR PROFESSIONELLE

### Product characteristics

Closing force (continuously adjustable)	Size acc. to EN	1/2/3/4
Door width	≤ 1.100 mm	■
Dimensions	Length in mm	209
	Depth in mm	38
	Height in mm	56
Mounting plate		-
Hinge side and hinge-opposite side		■
DIN left / right		■
Latching speed (adjustable from the side)		■
Closing speed (adjustable from the side)		■

- Yes
- No
- Option

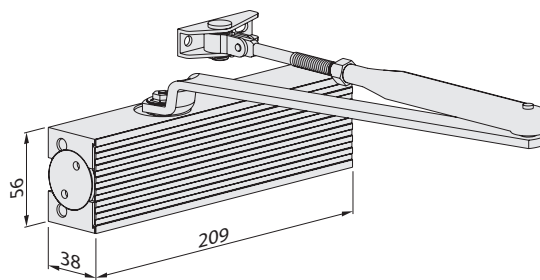

Dimensions: TS-14



**!** The different sizes are reached by moving the door closer on the door leaf.



Body: Silver RAL 9006  
ECOcllic: Stainless steel  
polished or satin



Body + ECOcllic:  
White RAL 9016



Body + ECOcllic:  
Black RAL 9005



Body + ECOcllic:  
Brown RAL 8014

Slide rail and arm are always delivered in the same colour as the ordered door closer body.

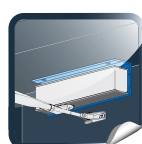

Under-lintel angle  
for door closer

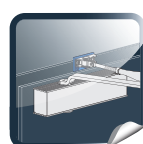

Adaptor profile

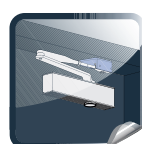

Angle bracket for parallel arm  
mounting

# Order information

## ECO Newton TS-14 ■ Door closer with standard arm

### Product information

- Closing force 1 / 2 / 3 / 4 acc. to EN (for door width up to 1.100 mm)  
Adjustable by moving the door closer.
- Latching speed and closing speed continuously adjustable from the side
- Same version DIN left and DIN right
- Height only 38 mm
- Max. door opening angle: 180°

### Article numbers



Door closer with standard arm	Colour	Article number	Door closer without standard arm	Colour	Article number
TS-14 (1/2/3/4)	Silver RAL 9006	301452E11A71010	TS-14 (1/2/3/4)	Silver RAL 9006	351452E11A00010
TS-14 (1/2/3/4)	White RAL 9016	301452E11E71010	TS-14 (1/2/3/4)	White RAL 9016	351452E11E00010
TS-14 (1/2/3/4)	Brown RAL 8014	301452E11D71010	TS-14 (1/2/3/4)	Brown RAL 8014	351452E11D00010
TS-14 (1/2/3/4)	Black RAL 9005	301452E11G71010	TS-14 (1/2/3/4)	Black RAL 9005	351452E11G00010

Autostadt VW, Wolfsburg,  
Germany

**SWISSDOOR**  
DÖRTEKNIK FÜR PROFESSIONELLE



## ECO Newton All a question of the system.

The new ECO Newton door closers are a part of the comprehensive ECO Schulte door fittings system. ECO Schulte thinks in terms of complete solutions and is one of the very few system providers dealing in all aspects of the door. From hinges to handles and from locking technology to single and double-leaf door closing systems, the company provides all safety relevant components from a single source. A unique, logical overall concept in regard to technology, function, form and service, because safety is inseparable.

# Hinge side

Illustration DIN left door, DIN right laterally reversed

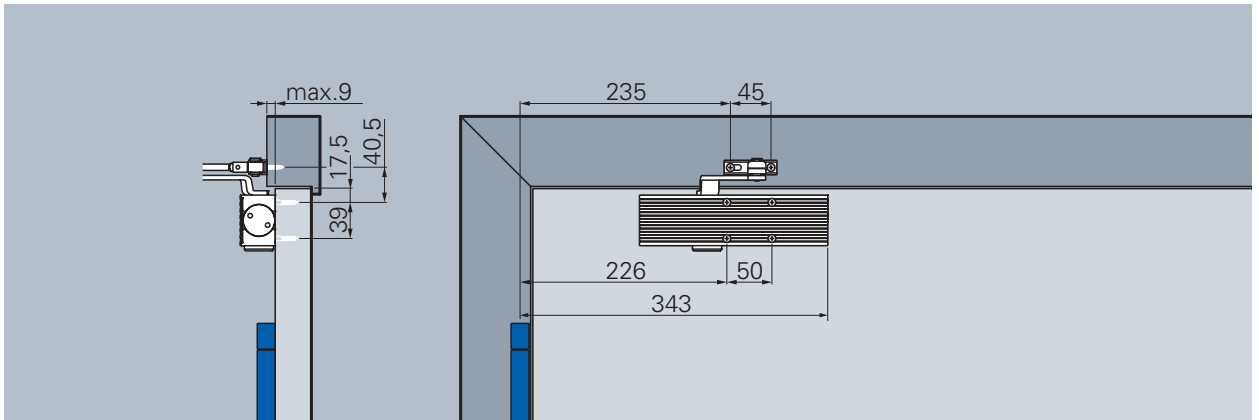

Standard mounting, hinge side (EN 3)

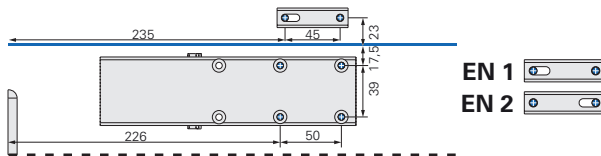

**Closing force EN 1/2**

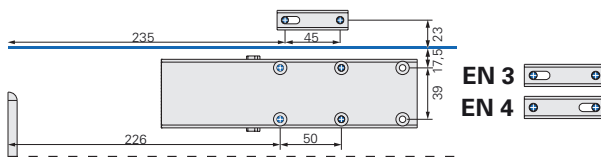

**Closing force EN 3/4**

### Closing force

The different sizes are reached by moving the door closer on the door leaf and by turning the standard arm reception by 180°.

Closing force diagram ECO Newton TS-14, hinge side

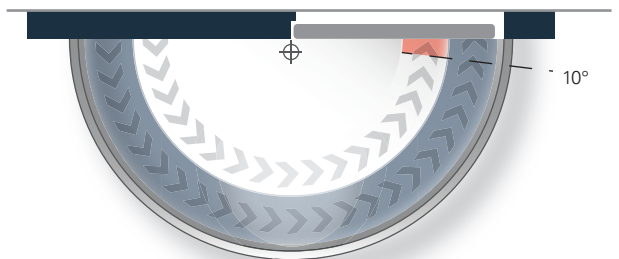

### Closing speed

Continuously adjustable closing speed from approx. 180° to 0°

### Latching speed

Increases the closing speed and thus the safe closing of the door, for example to overcome door seals, door locks and high air pressure.

Continuously adjustable, works between 10 to 0°

# Hinge-opposite side

Illustration DIN right door, DIN right laterally reversed

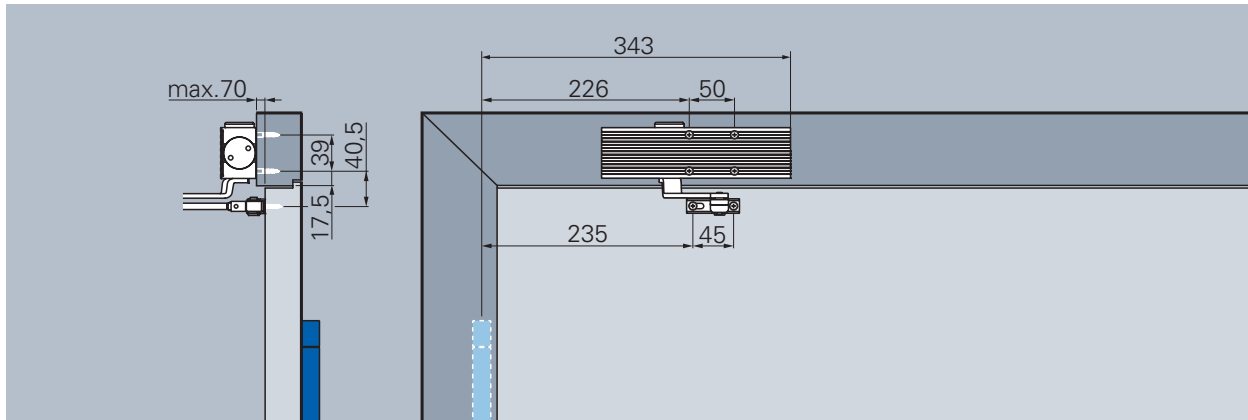

Head mounting, hinge-opposite side (EN 3)

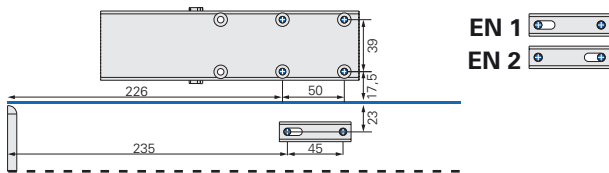

**Closing force EN 1/2**

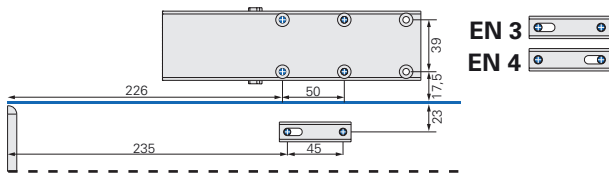

**Closing force EN 3/4**

## Closing force

The different sizes are reached by moving the door closer on the door leaf and by turning the standard arm reception by 180°.

Closing force diagram ECO Newton TS-14, hinge-opposite side



## Closing speed

Continuously adjustable closing speed from approx. 170°\* to 0°

## Latching speed

Increases the closing speed and thus the safe closing of the door, for example to overcome door seals, door locks and high air pressure.

Continuously adjustable, works between 10 to 0°

\*Varies according to door thickness and type of hinge

**A door stopper for opening limit is a must!**

**Danish seller:**

**Swissdoor ApS**  
Stenhuggervej 2  
DK-5471 Soendersoe  
Tlf.: +45 86 28 00 00  
mail@swissdoor.dk  
www.swissdoor.dk