

Planet[®] swiss

The door sealing experts







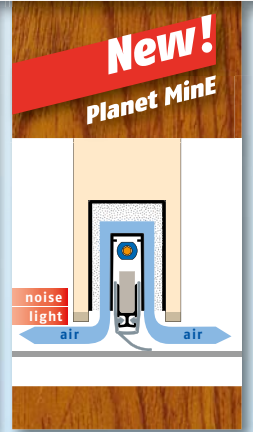
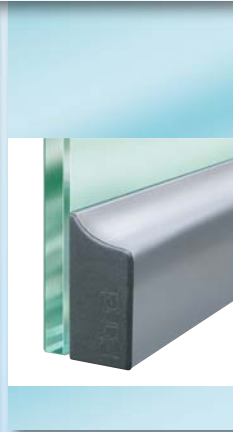

Planet drop down seals

 SWISS QUALITY



Planet selection table

Brochure page		4	4	5	5	6	6		7	7	8	8		10-11		12	*	*		*
Planet type		Planet HS	Planet RH	Planet FT	Planet RF	Planet Socle	Planet MinE		Planet MF	Planet RO	Planet RS	Planet PU		Planet KG		Planet SL	Planet BL	Planet GH		Planet Specials
Door material	 Wood	●	●	●	●	●	●		●	●	●	●		●		●	●	●		●
	 Metal	●	●	●	●	●	●		●	●	●	●		●		●	●	●		●
	 PVC	●	●	●	●	●	●		●	●	●	●		●		●	●	●		●
	 Glass													●						●
Door type	Wing doors	●	●	●	●	●	●		●	●	●	●		●			●	●		●
	2-wing doors	●	●	●	●	●	●		●	●	●	●		●		●	●	●		●
	Sliding doors	●	●	●	●	●	●		●	●	●	●		●		●	●	●		●
	Folding doors	●	●	●	●	●	●		●	●	●	●		●		●	●	●		●
	Swing doors	●	●	●	●	●	●		●	●	●	●		●		●	●	●		●
	WC-doors, forced ventilation						●													●
	Comfort ventilation						●													●
	Airlock doors						●													●
	Circular doors																			●
Function	Soundproof dB	●	●	●	●	●	●		●	●	●	●		●		●	●	●		●
	Smokeproof RD	●	●	●	●	●	●		●	●	●	●		●		●	●	●		●
	Fire resistant FH	●	●	●	●	●	●		●	●	●	●		●		●	●	●		●
	Escape doors	●	●	●	●	●	●		●	●	●	●		●			●	●		●
	Lead																●			●
2-wing doors	Flush bolt for bottom + top (page 9)	●	●	●	●		●		●	●	●	●					●			●
	Drill hole 5x13 mm (page 9)	●	●	●	●		●		●	●	●	●					●	●		●
	Diameter Ø 10,8 mm (page 9)								●	●	●	●								●
Lengths	from 220 mm	●	●	●	●	●	●		●	●	●	●								●
	from 335 mm													●			●	●		●
	from 460 mm															●				●
	up to 2000 mm						●													●
	up to 6000 mm	●	●	●	●	●			●	●	●	●		●		●	●	●		●
Lift height	16 mm								●	●	●	●		●						●
	18 mm																●			●
	20 mm (1 as an option )	●	●	●	●	●	●		1	1	1	1		1		●				●
	38 mm																	●		●
Fixing	Bottom fixed			●	●					●		●					●	●		●
	Side fixed	●	●				●		●		●					●		1		●
	Face fixed			●	●	●											●			●
	Bottom fixed with adhesive													●				1		●
	Face fixed with adhesive													●						●
For particularly uneven floors			●		●	●	●									●		●		●
	1 as an option 								1	1	1	1		1						●
Accessories	Floor recess plates	●	●	●	●	●	●		●	●	●	●		●			●	●		●
	Cambered sections	●	●	●	●	●	●		●	●	●	●		●		●	●	●		●
	Floor separator sills	●	●	●	●	●	●		●	●	●	●		●		●	●	●		●
	Planet accessories	●	●	●	●	●	●		●	●	●	●		●		●	●	●		●

* see full catalog

1 as an option with bevelled lip for particularly uneven floors

Door seals 13 x 30 mm



for wood, metal and PVC

Door seals 20 x 20 mm

for metal, PVC and wood

Door seals 16,5 x 35 mm

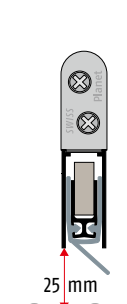
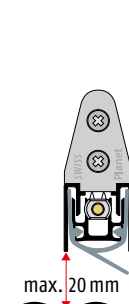
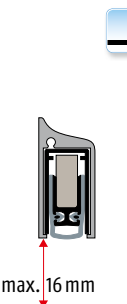
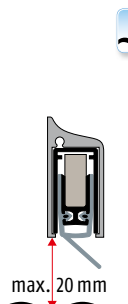
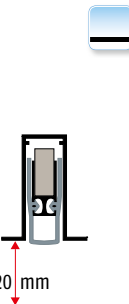
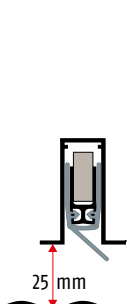
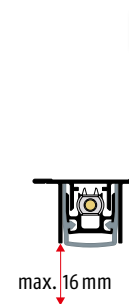
for glass

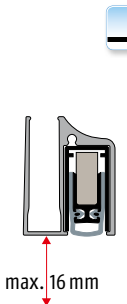
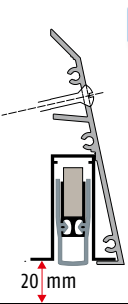
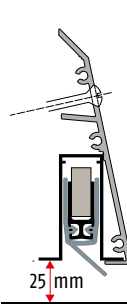
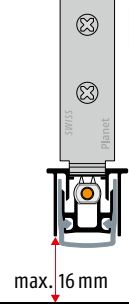
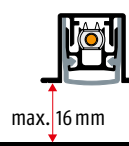
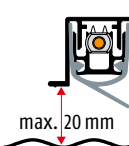
<p>HS 13x30 mm 48 dB</p>  <p>20 mm</p>	<p>RH 13x30 mm 42 dB</p>  <p>25 mm</p>	<p>MF 19,8x20 mm 50 dB</p>  <p>max. 16 mm</p>	<p>MF 19,8x20 mm 44 dB</p>  <p>max. 20 mm</p>	<p>KG-S Glass, 48 dB</p>  <p>max. 16 mm</p>	<p>KG-S Glass, 42 dB</p>  <p>max. 20 mm</p>
<p>FT 13x30 mm 48 dB</p>  <p>20 mm</p>	<p>RF 13x30 mm 42 dB</p>  <p>25 mm</p>	<p>RO 19,8/36x20 mm 50 dB</p>  <p>max. 16 mm</p>	<p>RO 19,8/36x20 mm 44 dB</p>  <p>max. 20 mm</p>	<p>KG-A8 A10 Glass 8 10 mm, 48 dB</p>  <p>max. 16 mm</p>	<p>KG-A8 A10 Glass 8 10 mm, 42 dB</p>  <p>max. 20 mm</p>
<p>Socle FT 22x69 mm 48 dB</p>  <p>20 mm</p>	<p>Socle RF 22x69 mm 42 dB</p>  <p>25 mm</p>	<p>RS 20,8/24x20 mm 50 dB</p>  <p>max. 16 mm</p>	<p>RS 20,8/24x20 mm 44 dB</p>  <p>max. 20 mm</p>	<p>KG-F8 F10 F12 Glass 8 10 12 mm, 48 dB</p>  <p>max. 16 mm</p>	<p>KG-F8 F10 F12 Glass 8 10 12 mm, 42 dB</p>  <p>max. 20 mm</p>
<p>MinE-S MinE-V 13x30/30x43 mm 28 dB</p>  <p>25 mm</p>	<p>SL 21,8x30,5 mm 42 dB</p>  <p>25 mm</p>	<p>PU 19,8x20 mm 50 dB</p>  <p>max. 16 mm</p>	<p>PU 19,8x20 mm 44 dB</p>  <p>max. 20 mm</p>	<p>KG-SL10 Glass 10 mm, 42 dB</p>  <p>max. 20 mm</p>	

Planet HS



Profile dimension 13 x 30 ↓ 20



Important features

- Seal height up to ↓ 20 mm
- Silicone lip protected by deeper rebate
- Door adjustable at bottom without removal
- Unilateral release with parallel drop down
- Does not trail on the floor
- Automatic compensation to inclined floors
- One groove width for any requirement
- Even for double-wing doors with flush bolt or driving bar
- With optimal sealing, sound reduction of up to **48 dB**
- High-grade silicone lip, simple lift height adjustment
- Can be shortened to the next stock lengths

OPTIONS			
HS → RD 48 dB		HS → FH + RD 48 dB	
Art. No.	Length mm	Art. No.	Length mm
76034	335	77034	335
76046	460	77046	460
76059	585	77059	585
76071	710	77071	710
76084	835	77084	835
76096	960	77096	960
76109	1085	77109	1085
76121	1210	77121	1210
76134	1335	77134	1335
76146	1460	77146	1460
76600	<6000	77600	<6000

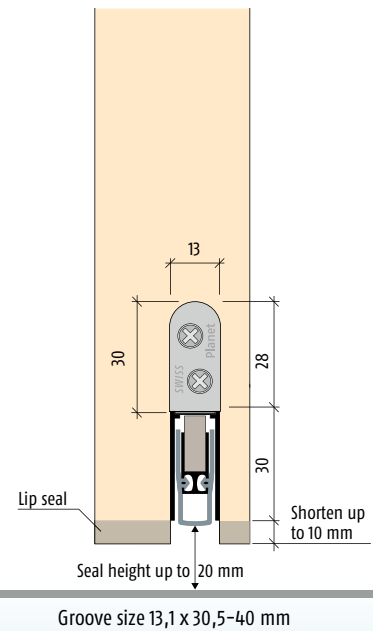

Planet HS



Planet RH for uneven floors



Profile dimension 13 x 30 ↓ 25



Important features

- Seal height up to ↓ 25 mm
- For humped, hollow, sloping and uneven floors
- Smooth bevelled silicone lip seal
- Compensation of inclined floor at 1000 mm door width: 15 mm
- Blocks out sound and light
- Unilateral release with parallel drop down
- Even for double-wing doors with flush bolt or driving bar
- With optimal sealing, sound reduction of up to **42 dB**
- Can be shortened to the next stock lengths

OPTIONS			
RH → RD 42 dB		RH → FH + RD 42 dB	
Art. No.	Length mm	Art. No.	Length mm
88034 L R	335	85034 L R	335
88046 L R	460	85046 L R	460
88059 L R	585	85059 L R	585
88071 L R	710	85071 L R	710
88084 L R	835	85084 L R	835
88096 L R	960	85096 L R	960
88109 L R	1085	85109 L R	1085
88121 L R	1210	85121 L R	1210
88134 L R	1335	85134 L R	1335
88146 L R	1460	85146 L R	1460
88600 L R	<6000	85600 L R	<6000

This seal is handed, select left (DIN L) or right hand (DIN R) when ordering – see diagram below

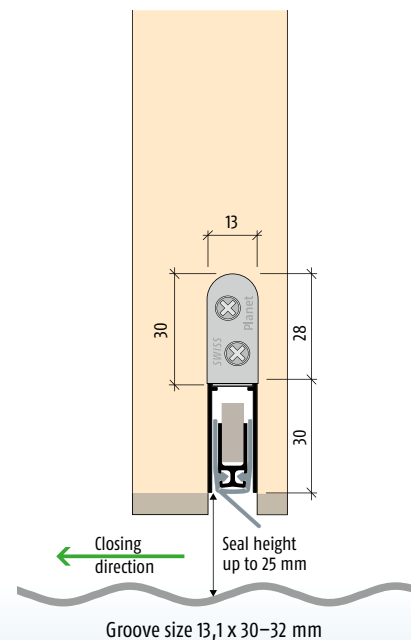

Planet RH

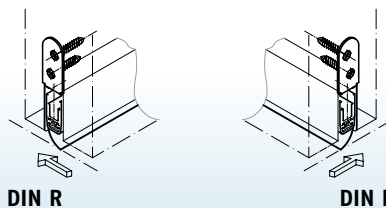

Planet FT

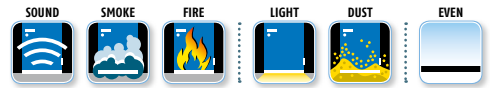

Profile dimension 13 x 30 ↓ 20

Important features

- Seal height up to ↓ 20 mm
- Unilateral release with parallel drop down
- Does not trail on the floor
- Automatic compensation to inclined floors
- One groove width for any requirement
- For double-wing doors with flush bolt or driving bar
- With optimal sealing, sound reduction of up to **48 dB**
- High-grade silicone lip, simple lift height adjustment
- Can be shortened to the next stock lengths

Option

Mounting with Planet Socle (page 6)

Planet FT

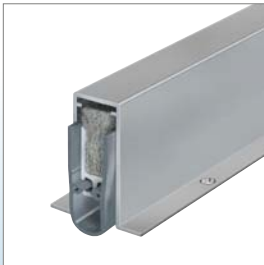

OPTIONS			
FT→RD 48 dB		FT→FH + RD 48 dB	
Art. No.	Length mm	Art. No.	Length mm
70035	350	71035	350
70045	450	71045	450
70055	550	71055	550
70065	650	71065	650
70075	750	71075	750
70085	850	71085	850
70095	950	71095	950
70105	1050	71105	1050
70115	1150	71115	1150
70125	1250	71125	1250
70135	1350	71135	1350
70145	1450	71145	1450
70600	<6000	71600	<6000

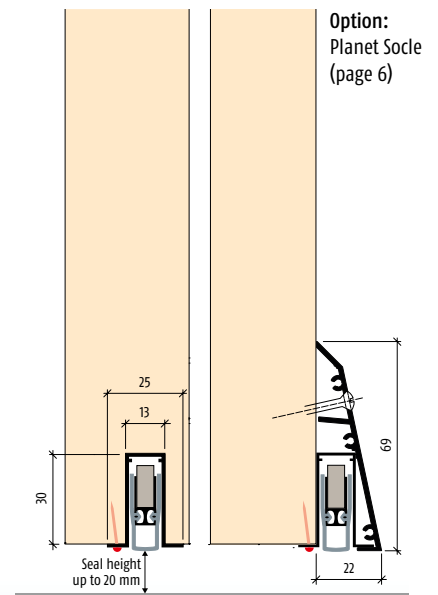

Groove size 13,1 x 30,5 mm



Planet RF for uneven floors

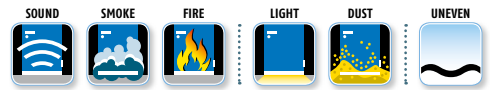

Profile dimension 13 x 30 ↓ 25

Important features

- Seal height up to ↓ 25 mm
- For humped, hollow, sloping and uneven floors
- Smooth bevelled silicone lip seal
- Compensation of inclined floor at 1000 mm door width: 15 mm
- Blocks out sound and light
- Unilateral release with parallel drop down
- Even for double-wing doors with flush bolt or driving bar
- With optimal sealing, sound reduction of up to **42 dB**
- Can be shortened to the next stock lengths

Option

Mounting with Planet Socle (page 6)

Planet RF



OPTIONS			
RF→RD 42 dB		RF→FH + RD 42 dB	
Art. No.	Length mm	Art. No.	Length mm
86035 L R	350	84035 L R	350
86045 L R	450	84045 L R	450
86055 L R	550	84055 L R	550
86065 L R	650	84065 L R	650
86075 L R	750	84075 L R	750
86085 L R	850	84085 L R	850
86095 L R	950	84095 L R	950
86105 L R	1050	84105 L R	1050
86115 L R	1150	84115 L R	1150
86125 L R	1250	84125 L R	1250
86135 L R	1350	84135 L R	1350
86145 L R	1450	84145 L R	1450
86600 L R	<6000	84600 L R	<6000

This seal is handed, select left (DIN L) or right hand (DIN R) when ordering – see diagram below

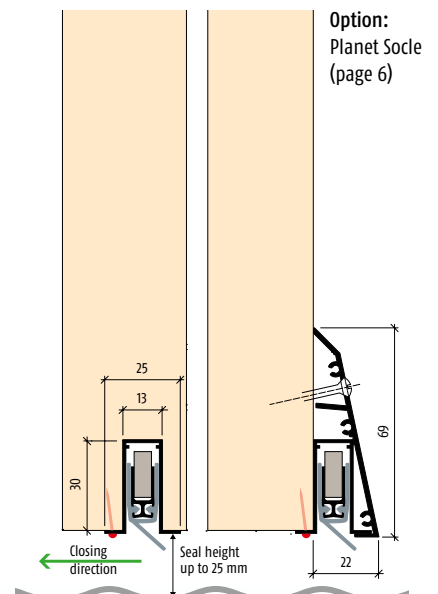

Groove size 13,1 x 30,5 mm

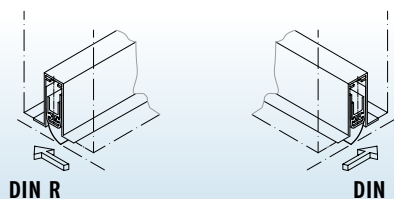

Planet Socle



Profile dimension 22 x 69

Important features

- appropriate for Planet FT, RF, BL
- ideal retrofit kit for existing doors
- simple assembly, attached on the doors
- the Planet Socle is used on any door without possibility to machine a groove, e.g. steel or aluminum doors. A quick and simple assembly, it can be done even in case of an old building refurbishment.

Option

- silver anodised finish EV1
- special socle for Planet GH version
- special steel on request

OPTIONS

Planet Socle → fit to Planet FT, RF, BL (GH on request)

Art. No.	Length mm
19055	550
19065	650
19075	750
19085	850
19095	950
19105	1050
19115	1150
19125	1250
19135	1350
19145	1450
19600	<6000

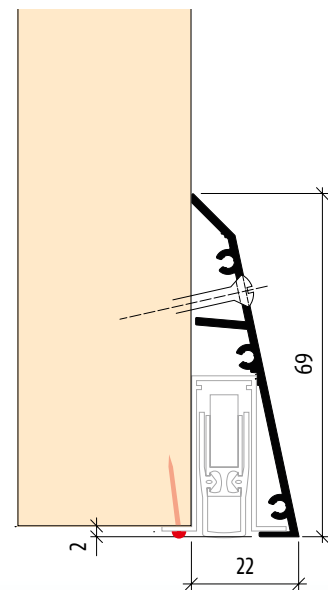

Planet Socle with Planet FT



Including bolts / cover plate



Planet MinE-S | MinE-V



Profile dimension 13 x 30 and 30 x 43 ↓ 25

Important features MinE-S

- Seal height up to ↓ 25 mm
- Blocking of sound while allowing air to flow through
- Sound absorption on seam of 28 dB at an air gap of 7 mm
- Air passage of 250 m³/h
- Reading 40 m³/h at a pressure difference of 3,2 Pa (door width 1050 mm)
- For humped, hollow, sloping and uneven floors
- Smooth bevelled silicone lip
- Compensation of inclined floor at 1000 mm door width: 15 mm
- Can be shortened to the next stock lengths

Option

For Planet MinE-V please have a look on our website www.planet.ag/en

OPTIONS

MinE-S → 28 dB		MinE-S → FH 28 dB	
Art. No.	Length mm	Art. No.	Length mm
40034 L R	335	41034 L R	335
40046 L R	460	41046 L R	460
40059 L R	585	41059 L R	585
40071 L R	710	41071 L R	710
40084 L R	835	41084 L R	835
40096 L R	960	41096 L R	960
40109 L R	1085	41109 L R	1085
40121 L R	1210	41121 L R	1210
40134 L R	1335	41134 L R	1335
40146 L R	1460	41146 L R	1460
40200 L R	<2000	41200 L R	<2000

This seal is handed, select left (DIN L) or right hand (DIN R) when ordering – see diagram below

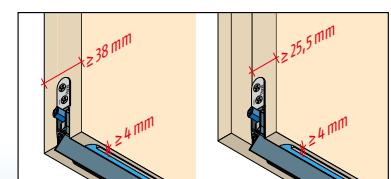
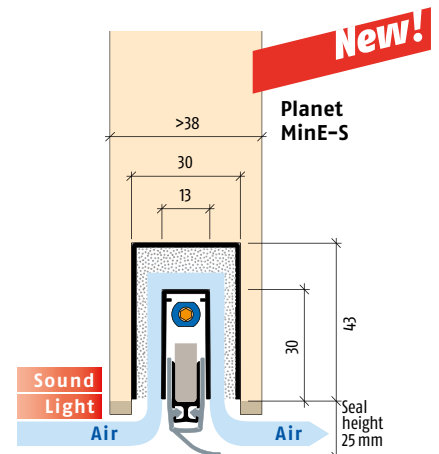
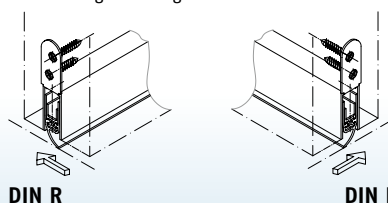

Planet MinE-S



Planet MF



Profile dimension 19,8 x 20 ↓ 16

Important features

- Seal height up to ↓ 16 mm
- Unilateral release with parallel drop down
- Does not trail on the floor
- Automatic compensation to inclined floors
- Even for double-wing doors with flush bolt or driving bar
- Acoustic isolation of **50 dB** (at 7 mm clearance door to floor)
- High-grade silicone lip, simple lift height adjustment
- Can be shortened to the next stock lengths

Option

- for uneven floors

OPTIONS			
MF → RD 50 dB		MF → FH + RD 50 dB	
Art. No.	Length mm	Art. No.	Length mm
50034	335	51034	335
50046	460	51046	460
50059	585	51059	585
50071	710	51071	710
50084	835	51084	835
50096	960	51096	960
50109	1085	51109	1085
50121	1210	51121	1210
50134	1335	51134	1335
50146	1460	51146	1460
50159	1585	51159	1585
50600	<6000	51600	<6000

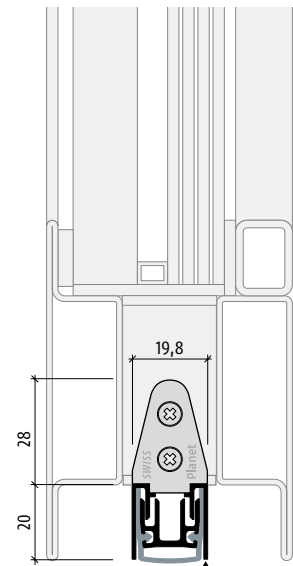

Seal height up to 16 mm

Groove size 20 x 20,5-25 mm



Planet MF



Planet R0

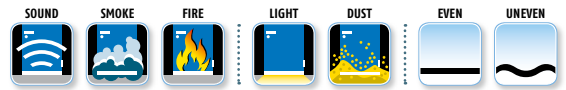

Profile dimension 19,8 | 36 x 20 ↓ 16

Important features

- Seal height up to ↓ 16 mm
- Unilateral release with parallel drop down
- Does not trail on the floor
- Automatic compensation to inclined floors
- Even for double-wing doors with flush bolt or driving bar
- Acoustic isolation of **50 dB** (at 7 mm clearance door to floor)
- High-grade silicone lip, simple lift height adjustment
- Can be shortened to the next stock lengths

Option

- for uneven floors

OPTIONS			
R0 → RD 50 dB		R0 → FH + RD 50 dB	
Art. No.	Length mm	Art. No.	Length mm
56034	335	57034	335
56046	460	57046	460
56059	585	57059	585
56071	710	57071	710
56084	835	57084	835
56096	960	57096	960
56109	1085	57109	1085
56121	1210	57121	1210
56134	1335	57134	1335
56146	1460	57146	1460
56159	1585	57159	1585
56600	<6000	57600	<6000

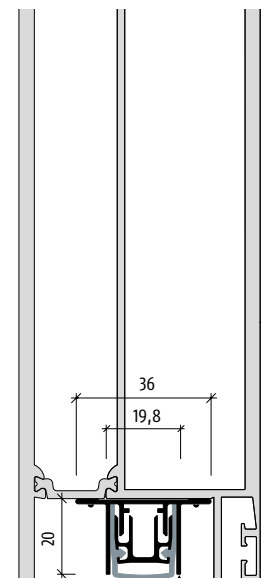

Seal height up to 16 mm



Planet R0



Planet RS

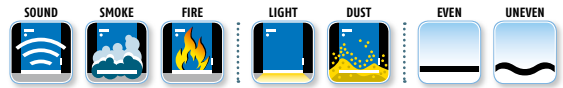

Profile dimension 20,8 | 24 x 20 ↓ 16



Important features

- Fixing bracket suitable for ↓16 mm Euro groove
- Suitable for 24 mm entry door groove
- Unilateral release with parallel drop down
- Does not trail on the floor
- Automatic compensation to inclined floors
- Even for double-wing doors with flush bolt or driving bar
- Acoustic isolation of **50 dB** (at 7 mm clearance door to floor)
- High-grade silicone lip, simple lift height adjustment
- Mounting set for all popular system manufacturers
- Can be shortened to the next stock length

Option

- for uneven floors 

Planet RS



OPTIONS			
RS → RD 50 dB		RS → FH + RD 50 dB	
Art. No.	Length mm	Art. No.	Length mm
55034	335	59034	335
55046	460	59046	460
55059	585	59059	585
55071	710	59071	710
55084	835	59084	835
55096	960	59096	960
55109	1085	59109	1085
55121	1210	59121	1210
55134	1335	59134	1335
55146	1460	59146	1460
55159	1585	59159	1585
55600	<6000	59600	<6000

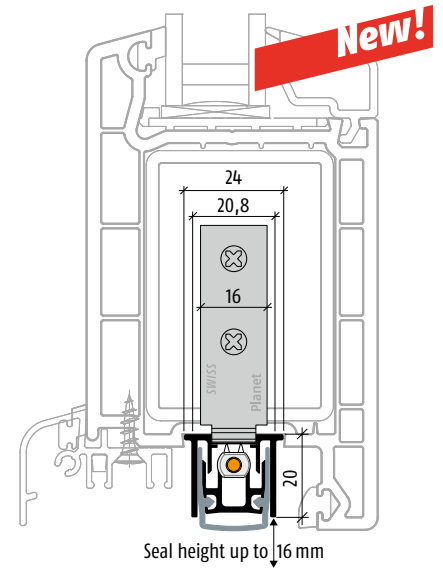

Planet PU

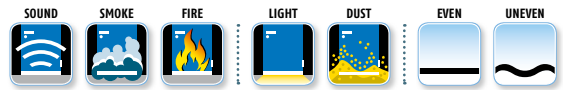

Profile dimension 19,8 x 20 ↓ 16



Important features

- Seal height up to ↓16 mm
- unilateral release with parallel drop-down
- does not trail on the floor
- automatic compensation to inclined floors
- even for double-wing doors with flush bolt or driving bar
- acoustic insulation of **50 dB** (at 7 mm space to the floor)
- can be shortened to the next shorter length in stock
- high-grade silicone lip, simple lift height adjustment
- Can be shortened to the next stock length

Option

- for uneven floors 

Planet PU



OPTIONS			
PU → RD 42 dB		PU → FH + RD 42 dB	
Art. No.	Length mm	Art. No.	Length mm
73059 L R	585	74059 L R	585
73071 L R	710	74071 L R	710
73084 L R	835	74084 L R	835
73096 L R	960	74096 L R	960
73109 L R	1085	74109 L R	1085
73121 L R	1210	74121 L R	1210
73134 L R	1335	74134 L R	1335
73146 L R	1460	74146 L R	1460
73600 L R	<6000	74600 L R	<6000

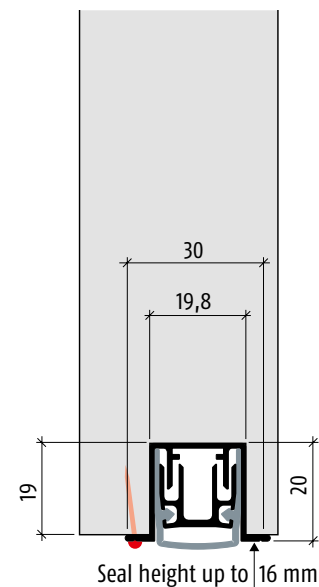

Groove size 22 x 30,5 mm



Planet KR flush bolt and driving bar rods

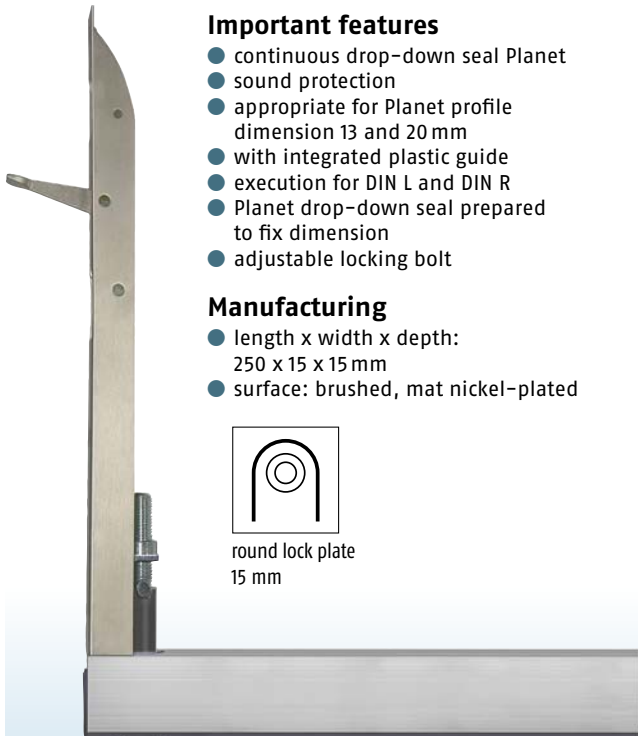



Important features

- continuous drop-down seal Planet
- sound protection
- appropriate for Planet profile dimension 13 and 20 mm
- with integrated plastic guide
- execution for DIN L and DIN R
- Planet drop-down seal prepared to fix dimension
- adjustable locking bolt

Manufacturing

- length x width x depth: 250 x 15 x 15 mm
- surface: brushed, mat nickel-plated



round lock plate 15 mm

Planet flush bolt with Planet HS drill hole 5x13 mm

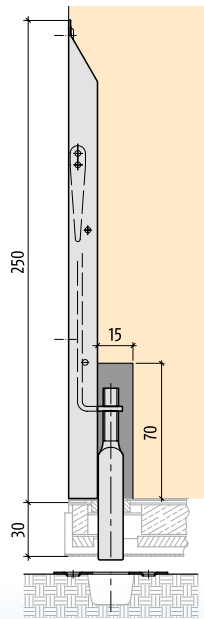

Planet KR round lock plate, width 15 mm with Planet HS in the stationary wing.



Planet KR Flush bolt, applicable on bottom and top with round lock plate 15 mm.

Planet drill hole 5x13 mm and Ø 10,8 mm



Profile dimension 13 + 19,8

Order information

- Article number
- Fixed dimension
- Mandrel size from 20 up to 100 mm
- DIN L or DIN R

PLANET DRILL HOLES	
Drill hole 5x13 mm	Drill hole Ø 10,8 mm
Art. No. 900190	Art. No. 900280

Planet HS drill hole 5x13 mm



Planet MF drill hole Ø 10,8 mm

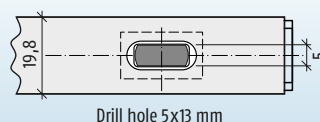
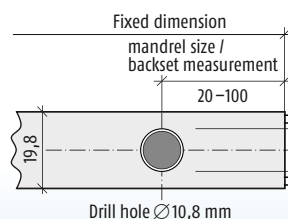
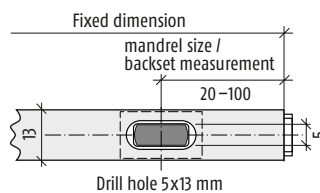

Driving bar rods supplied by lock manufacturers:

WILKA, BKS, FUHR, MSL, BMH, Strenger, etc.



Planet BM 5x13 mm narrow, floor recess plate

Planet KG-A8 | A10

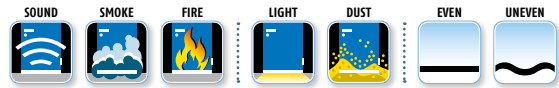

Profile dimension 16,5 x 35 ↓ 16



Important features

- Seal height up to ↓ 16 mm
- For single- and double-wing all-glass doors of 8 to 10 mm thickness
- Drop-down seal for pushing on and bonding
- Unilateral release with parallel drop down
- Does not trail on the floor
- Automatic compensation to inclined floors
- Acoustic isolation of **48 dB** (at 7 mm clearance door to floor)
- Can be shortened to the next stock lengths

Option

- fire-retardant+smoke-shielding+sound protection
- for uneven floors

OPTIONS			
KG-A8 A10 → RD 48 dB		KG-A8 A10 → FH + RD 48 dB	
silver anodised finish EV1		stainless steel effect	
Art. No.	Length mm	Art. No.	Length mm
38046-A8 A10	459	39046-A8 A10	459
38059-A8 A10	584	39059-A8 A10	584
38071-A8 A10	709	39071-A8 A10	709
38084-A8 A10	834	39084-A8 A10	834
38096-A8 A10	959	39096-A8 A10	959
38109-A8 A10	1084	39109-A8 A10	1084
38121-A8 A10	1209	39121-A8 A10	1209
38134-A8 A10	1334	39134-A8 A10	1334
38146-A8 A10	1459	39146-A8 A10	1459
38200-A8 A10	<6000	39200-A8 A10	<6000

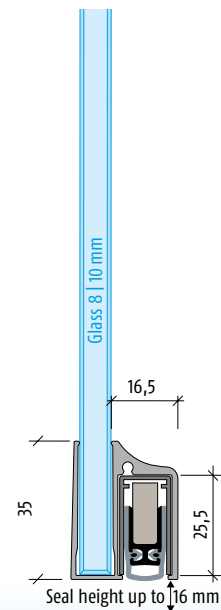

Planet KG-A10

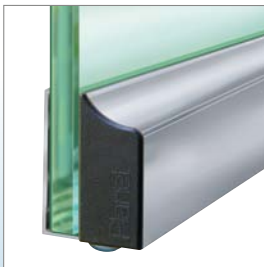

Planet KG-F8 | F10 | F12



Profile dimension 16,5 x 46 ↓ 16



Important features

- Seal height up to ↓ 16 mm
- For single- and double-wing all-glass doors of 8, 10 and 12 mm thickness
- Drop-down seal for pushing on and bonding
- Unilateral release with parallel drop down
- Does not trail on the floor
- Automatic compensation to inclined floors
- Acoustic isolation of **48 dB** (at 7 mm clearance door to floor)
- Can be shortened to the next stock lengths

Option

- fire-retardant+smoke-shielding+sound protection
- for uneven floors

OPTIONS			
KG-F8 F10 F12 → RD 48 dB		KG-F8 F10 F12 → FH + RD 48 dB	
silver anodised finish EV1		stainless steel effect	
Art. No.	Length mm	Art. No.	Length mm
37046-F8 F10 F12	459	39046-F8 F10 F12	459
37059-F8 F10 F12	584	39059-F8 F10 F12	584
37071-F8 F10 F12	709	39071-F8 F10 F12	709
37084-F8 F10 F12	834	39084-F8 F10 F12	834
37096-F8 F10 F12	959	39096-F8 F10 F12	959
37109-F8 F10 F12	1084	39109-F8 F10 F12	1084
37121-F8 F10 F12	1209	39121-F8 F10 F12	1209
37134-F8 F10 F12	1334	39134-F8 F10 F12	1334
37146-F8 F10 F12	1459	39146-F8 F10 F12	1459
37160-F8 F10 F12	<6000	39160-F8 F10 F12	<6000

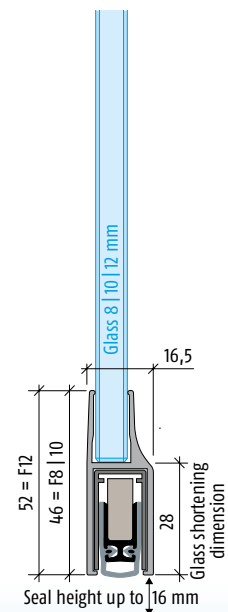

Planet KG-F10



Planet KG-SM-Set | KG-S

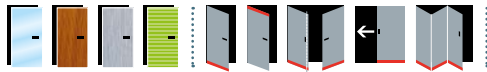

Profile dimension 16,5 x 35 ↓ 16

Important features

- Seal height up to ↓ 16 mm
- Planet KG-S affixed at the side with UV adhesive or double-sided adhesive tape
- Planet drop-down seal cemented in the S protection profile
- Unilateral release with parallel drop down
- Does not trail on the floor
- Automatic compensation to inclined floors
- Acoustic isolation of **48 dB** (at 7 mm floor to door clearance)
- Can be shortened to the next stock lengths

Option

- for uneven floors 

OPTIONS			
KG-SM-Set		KG-SM-Set	
silver anodised finish EV1		stainless steel effect	
Art. No.	Length mm	Art. No.	Length mm
38046-SM	459	38046-SMX	459
38059-SM	584	38059-SMX	584
38071-SM	709	38071-SMX	709
38084-SM	834	38084-SMX	834
38096-SM	959	38096-SMX	959
38109-SM	1084	38109-SMX	1084
38121-SM	1209	38121-SMX	1209
38134-SM	1334	38134-SMX	1334
38146-SM	1459	38146-SMX	1459

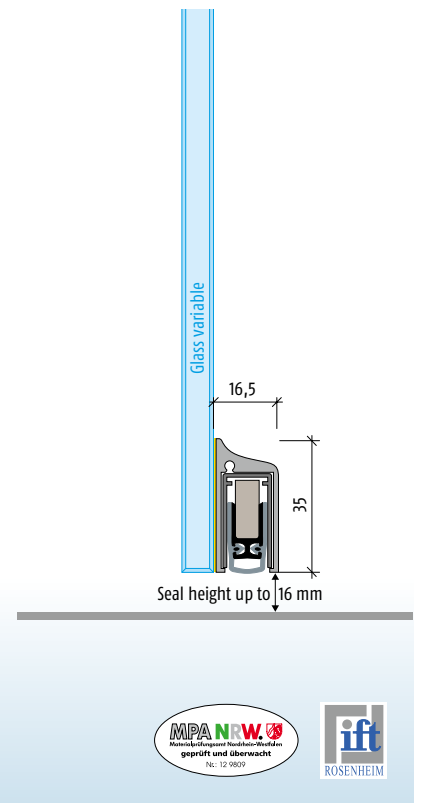

Planet KG-S

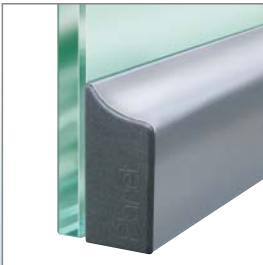

Complete Planet KG-SM-Set



Planet KG-SL10



Profile dimension 25 x 46 ↓ 20

Important features

- Seal height up to ↓ 20 mm
- Planet KG-S affixed at the side with UV adhesive or double-sided adhesive tape
- Planet drop-down seal cemented in the S protection profile
- Unilateral release with parallel drop down
- Does not trail on the floor
- Acoustic isolation of **42 dB** (at 7 mm floor to door clearance)
- Can be shortened to the next stock lengths

Option

- fire-retardant+smoke-shielding+sound protection

Planet KG-SL10



OPTIONS			
KG-SL10 → RD 42 dB		KG-SL10 → FH + RD 42 dB	
silver anodised finish EV1		stainless steel effect	
Art. No.	Length mm	Art. No.	Length mm
37046-SL10 L R	459	39046-SL10 L R	459
37059-SL10 L R	584	39059-SL10 L R	584
37071-SL10 L R	709	39071-SL10 L R	709
37084-SL10 L R	834	39084-SL10 L R	834
37096-SL10 L R	959	39096-SL10 L R	959
37109-SL10 L R	1084	39109-SL10 L R	1084
37121-SL10 L R	1209	39121-SL10 L R	1209
37134-SL10 L R	1334	39134-SL10 L R	1334
37146-SL10 L R	1459	39146-SL10 L R	1459
37160-SL10 L R	<6000	39160-SL10 L R	<6000

This seal is handed, select left (DIN L) or right hand (DIN R) when ordering – see diagram below

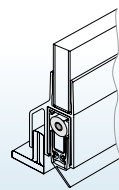

DIN R

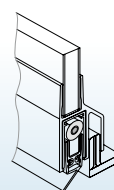

DIN L

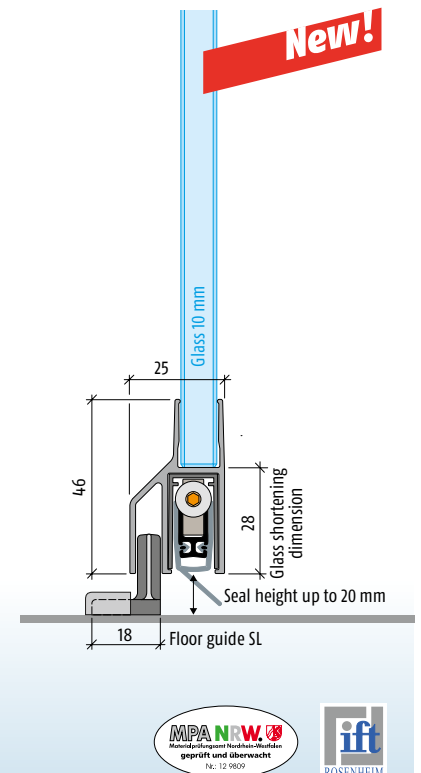

Planet SL



Profile dimension 21,8 x 30 ↓ 25

Important features

- Seal height up to ↓ 25 mm
- Planet SL for sliding doors
- Compact, space-saving solution with integrated floor guide groove
- Floor guide enclosed, adjustable
- Lock-side release with parallel drop down
- Automatic compensation to inclined floors
- Acoustic isolation of **42 dB** (at 7 mm clearance door to floor)
- Can be shortened to the next stock length
- High-grade silicone lip, simple lift height adjustment
- Can be shortened to the next stock lengths

OPTIONS			
SL → RD 42 dB		SL → FH + RD 42 dB	
Art. No.	Length mm	Art. No.	Length mm
73059 L R	585	74059 L R	585
73071 L R	710	74071 L R	710
73084 L R	835	74084 L R	835
73096 L R	960	74096 L R	960
73109 L R	1085	74109 L R	1085
73121 L R	1210	74121 L R	1210
73134 L R	1335	74134 L R	1335
73146 L R	1460	74146 L R	1460
73600 L R	<6000	74600 L R	<6000

This seal is handed, select left (DIN L) or right hand (DIN R) when ordering – see diagram below

Planet SL

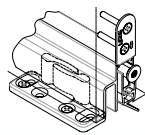

DIN R

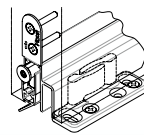

DIN L

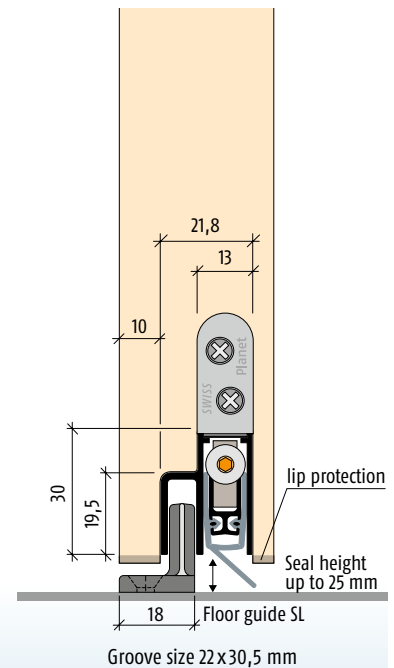

Fax reply: +41 43 266 22 23 or email: mail@planet.ag

Company _____

Last name _____

First name _____

Street / Number _____

Postcode / City _____

Country _____

Phone _____

Email _____ Date _____

(Please write in capital letters)

Please send me the Planet catalog

Please contact me

Please return this complete filled in form to Planet GDZ AG

Company stamp

Request the new Planet catalog or find out more at our website: www.planet.ag

